

# Samkoon



## SK SERIES HMI INSTRUCTION

# SK SERIES HMI INSTRUCTION

|   |     |
|---|-----|
| 1. HMI Specification .....                      | 7   |
| 2. Preface .....                                | 8   |
| 3. Hardware Manual .....                        | 10  |
| 3.1 General .....                               | 10  |
| 3.2 Mounting dimensions .....                   | 15  |
| 3.2.1 SK-035 .....                              | 15  |
| 3.2.2 SK-043 .....                              | 16  |
| 3.2.3 SK-050 .....                              | 19  |
| 3.2.4 SK-057 .....                              | 20  |
| 3.2.5 SK-070 .....                              | 20  |
| 3.2.6 SK-102 .....                              | 23  |
| 3.2.7 SK-104 .....                              | 24  |
| 3.2.8 SK-121 .....                              | 25  |
| 3.3 HMI Structure .....                         | 25  |
| 3.3.1 Power Interface .....                     | 26  |
| 3.3.2 Front panel .....                         | 27  |
| 3.3.3 Communication port .....                  | 27  |
| 3.3.4 Pin .....                                 | 28  |
| 3.3.5 Running Indicator Lights .....            | 29  |
| 3.4 Technical Parameters .....                  | 30  |
| 3.5 Wiring .....                                | 39  |
| 4. Quick start of SKTOOL .....                  | 41  |
| 4.1 What's SKTOOL .....                         | 41  |
| 4.2 System demand .....                         | 43  |
| 4.2.1 Software demand .....                     | 43  |
| 4.2.2 Hardware demand .....                     | 43  |
| 4.3 Set up Software .....                       | 44  |
| 4.4 Uninstall Software .....                    | 50  |
| 4.5 Run SKTOOL .....                            | 53  |
| 4.6 Edit Interface and System Composition ..... | 54  |
| 4.6.1 Edit Interface .....                      | 54  |
| 4.6.2 System Composition .....                  | 79  |
| 4.7 Basic Operations .....                      | 80  |
| 4.7.1 Mouse usage and shortcut keys .....       | 80  |
| 4.7.2 Common terms .....                        | 82  |
| 5. Basic steps of creating a new project .....  | 84  |
| 5.1 Create new project .....                    | 84  |
| 5.2 Set parameters and add graphic object ..... | 89  |
| 5.3 Download configuration engineering .....    | 95  |
| 5.4 Upload configuration engineering .....      | 99  |
| 5.5 Upload historical data record .....         | 100 |
| 5.6 Pack/Unpack .....                           | 101 |
| 6. SKTOOL Configuration Guide .....             | 103 |
| 6.1 Screen Operations .....                     | 103 |
| 6.1.1 Create a New Screen .....                 | 104 |
| 6.1.2 Modify Screen Property .....              | 105 |
| 6.1.3 Delete Screen .....                       | 106 |
| 6.1.4 Copy Screen .....                         | 107 |
| 6.1.5 Automatic sorting .....                   | 107 |
| 6.2 Graphics editing commands .....             | 108 |
| 6.2.1 Group and Ungroup .....                   | 109 |
| 6.2.2 Layer .....                               | 110 |
| 6.2.3 Rotaty .....                              | 112 |
| 6.2.4 Align .....                               | 114 |

|   |     |
|---|-----|
| This chapter details operations of drawing basic graphics with SKTOOL ..... | 118 |
| Contents: .....   | 118 |
| 6.3.1 Line .....  | 119 |
| 6.3.2 Polyline .....  | 120 |
| 6.3.3 Curve / Arc .....   | 121 |
| 6.3.4 Free Line .....   | 122 |
| 6.3.5 Rectangle .....   | 123 |
| 6.3.6 Rounded Rectangle .....   | 124 |
| 6.3.7 Circle/Ellipse .....  | 125 |
| 6.3.8 Polygon .....   | 126 |
| 6.3.9 Sector .....  | 127 |
| 6.3.10 Text .....   | 128 |
| 6.3.11 Table .....  | 129 |
| 6.3.12 Scale .....  | 130 |
| 6.3.13 Open Library .....   | 132 |
| 6.3.14 Extern Picture .....   | 134 |
| 6.3.15 Regular polygon .....  | 137 |
| 6.4 SKTOOL Advanced controls .....  | 138 |
| 6.4.1 GIF Display .....   | 139 |
| 6.4.2 Trend Chart .....   | 141 |
| 6.4.3 XY Trend Chart .....  | 146 |
| 6.4.4 Historical Trend Chart .....  | 147 |
| 6.4.5 Dynamic Circle .....  | 152 |
| 6.4.6 Dynamic Rectangle .....   | 154 |
| 6.4.7 Alarm Display .....   | 156 |
| 6.4.8 Alarm Bar .....   | 157 |
| 6.4.9 Historical Alarm Display .....  | 159 |
| 6.4.10 Graphic Move .....   | 160 |
| 6.4.11 Meter .....  | 162 |
| 6.4.12 Historical Data Display .....  | 165 |
| 6.4.13 Message Display .....  | 168 |
| 6.4.14 Flow block .....   | 170 |
| 6.4.15 Timer .....  | 171 |
| 6.4.16 Multi-function Button .....  | 177 |
| 6.4.17 Pie Chart .....  | 179 |
| 6.5 SKTOOL Basic controls .....   | 180 |
| 6.5.1 Bit Button .....  | 181 |
| 6.5.2 Word Button .....   | 191 |
| 6.5.3 Bit Lamp .....  | 193 |
| 6.5.4 Screen button .....   | 195 |
| 6.5.5 Function Button .....   | 198 |
| 6.5.6 Multi-state Button .....  | 202 |
| 6.5.7 Multi-state Indicator Lamp .....                                      | 206 |
| 6.5.8 Numerical Display .....   | 211 |
| 6.5.9 Numerical Input .....   | 216 |
| 6.5.10 ASCII Display .....  | 221 |
| 6.5.11 ASCII Input .....  | 223 |
| 6.5.12 Bar Graph .....  | 224 |
| 6.5.13 Time Display .....   | 228 |
| 6.5.14 Date Display .....   | 229 |
| 6.5.15 Week Display .....   | 230 |
| 6.5.16 Static Picture .....   | 232 |
| 6.5.17 Picture Display .....  | 232 |
| 6.6 SKTOOL New controls .....   | 234 |
| 6.6.1 Arc Chart .....   | 235 |
| 6.6.2 Stepping Button .....   | 236 |

|   |     |
|---|-----|
| 6.6.3 Radio Button .....  | 237 |
| 6.6.4 Combo Box .....   | 238 |
| 6.6.5 Slider .....  | 240 |
| 6.6.6 Animation .....   | 241 |
| 6.6.7 Message Board .....   | 245 |
| 6.6.8 Data Group Display .....  | 246 |
| 6.6.9 Keyboard .....  | 248 |
| 6.6.10 Recipe Selector .....  | 250 |
| 6.6.11 Recipe Display .....   | 252 |
| 6.6.12 Qrcode .....   | 254 |
| 6.6.13 Operation Log .....  | 255 |
| 6.6.14 Corner Flow Block .....  | 256 |
| 6.6.15 Multi Window .....   | 258 |
| 6.6.16 Path display .....   | 262 |
| Path display general dialog box .....                                       | 262 |
| Index of related elements: point, line, arc, circle, thickness, color ..... | 263 |
| Address description of the reception area of the selected report .....      | 265 |
| 6.6.17 Scroll bar .....   | 266 |
| 6.6.18 Pipeline .....   | 271 |
| 6.6.19 Dial .....   | 279 |
| 6.7 SKTOOL Control Instructions .....                                       | 285 |
| 7. Script .....   | 288 |
| 7.1 Introduction to C language .....  | 289 |
| 7.1.1 Data type of C language .....   | 289 |
| 7.1.2 Initial value of variable and type conversion .....                   | 296 |
| 7.1.3 One-dimensional array .....   | 298 |
| 7.1.5 Section summary .....   | 302 |
| 7.2 C language programming preliminary .....                                | 304 |
| 7.2.1 Statement of C program .....  | 304 |
| 7.2.2 Branch structure program .....  | 306 |
| 7.2.3 switch statement .....  | 310 |
| 7.2.4 Loop structure program .....  | 311 |
| 7.2.5 for statement .....   | 313 |
| 7.2.6 break statement .....   | 314 |
| 7.2.7 continue statement .....  | 315 |
| 7.2.8 Section summary .....   | 315 |
| 7.3 Script function introduction .....                                      | 317 |
| 7.3.1 Use script function to program .....                                  | 318 |
| 7.3.2 Function button introduction in script editor .....                   | 319 |
| 7.3.3 Macro Encryption/Decryption .....                                     | 322 |
| 7.3.4 New create script .....   | 326 |
| 7.3.5 Use internal storage area in script .....                             | 327 |
| 7.4 String handling functions .....   | 328 |
| 7.5 Data operation function .....   | 333 |
| 7.6 Data switch function .....  | 337 |
| 7.7 Math arithmetic functio .....   | 340 |
| 7.8 Communication function .....  | 345 |
| 7.9 CAN communication function .....  | 351 |
| 8. Simulation .....   | 354 |
| 8.1 Offline Simulation .....  | 354 |
| 8.2 Online Simulation .....   | 356 |
| 9. System Settings .....  | 358 |
| 9.1 Communication Port Property .....                                       | 358 |
| 9.2 Setting .....   | 360 |
| 9.2.2 HMI parameter settings .....  | 365 |
| 9.2.3 HMI State .....   | 371 |

|   |     |
|---|-----|
| 9.2.4 PLC Control .....                                   | 372 |
| 9.2.5 Clock .....   | 375 |
| 9.2.6 File Encryption .....                               | 377 |
| 9.2.7 HMI Protection .....                                | 378 |
| 9.2.8 Variable Table .....                                | 383 |
| 9.2.9 The operation setting .....                         | 384 |
| 9.2.10 Text Library .....                                 | 385 |
| 9.2.11 Address Library .....                              | 388 |
| 9.3 Screen .....  | 392 |
| 9.4 Window .....  | 393 |
| 9.5 Historical Data Collector .....                       | 394 |
| 9.6 Alarm settings .....                                  | 400 |
| 9.6.1 Digital Alarm Login .....                           | 400 |
| 9.6.2 Analog Alarm Login .....                            | 406 |
| 9.6.3 Discrete alarm login .....                          | 408 |
| 9.6.4 Alarm Display Controls .....                        | 410 |
| 9.7 Recipe .....  | 413 |
| 9.8 Data Transmission .....                               | 419 |
| 9.9 Global Script .....                                   | 421 |
| 9.10 Init Script .....                                    | 422 |
| 9.11 Trigger_Script .....                                 | 422 |
| 9.12 Data forwarding .....                                | 425 |
| 9.13 Schedule Table .....                                 | 426 |
| 10. Reserved Registers of SKTOOL System .....             | 431 |
| 10.1 LB .....   | 431 |
| 10.2 LW .....   | 439 |
| 10.3 RWI .....  | 459 |
| 11. Connection among multiple screens and machines .....  | 461 |
| 11.1 "One machine with multiple screens" connection ..... | 461 |
| 11.2 "One screen with multiple machines" connection ..... | 466 |
| 11.3 Penetration connection .....                         | 469 |
| 11.4 Modbus TCP/IP .....                                  | 474 |
| 12. Device driver .....                                   | 479 |
| 12.1 Samkoon device driver .....                          | 484 |
| 12.2 AIBUS device driver .....                            | 487 |
| 12.3 Allen-Bradley device driver .....                    | 490 |
| 12.4 CAN Device Driver .....                              | 499 |
| 12.5 Delta device driver .....                            | 502 |
| 12.6 Emerson device driver .....                          | 504 |
| 12.7 Fatek device driver .....                            | 507 |
| 12.8 Fuji device driver .....                             | 510 |
| 12.9 GE device driver .....                               | 512 |
| 12.10 HaiWell device driver .....                         | 515 |
| 12.11 Hitachi device driver .....                         | 517 |
| 12.12 HollySys device driver .....                        | 520 |
| 12.13 IDEC device driver .....                            | 523 |
| 12.14 Inovance device driver .....                        | 526 |
| 12.15 Keyence device driver .....                         | 528 |
| 12.16 Koyo device driver .....                            | 532 |
| 12.17 LG device driver .....                              | 535 |
| 12.18 Matsushita device driver .....                      | 540 |
| 12.19 Mitsubishi device driver .....                      | 543 |
| 12.20 Modbus device driver .....                          | 552 |
| 12.21 Modicon device driver .....                         | 556 |
| 12.22 Nanda device driver .....                           | 559 |
| 12.23 Omron device driver .....                           | 561 |

|  |     |
|--|-----|
| 12.24 Siemens device driver .....                                    | 565 |
| 12.25 TaiAn device driver .....                                      | 572 |
| 12.26 TaiLing device driver .....                                    | 575 |
| 12.27 Techwayson device driver .....                                 | 577 |
| 12.28 Vigor device driver .....                                      | 580 |
| 12.29 Xinje device driver .....                                      | 582 |
| 12.30 Yokogawa device driver .....                                   | 587 |
| 12.31 ZhengHang device driver .....                                  | 589 |
| 13. Number signals of communication errors between HMI and PLC ..... | 593 |
| 14. Appendix .....   | 596 |
| 14.1 Export data via U disk .....                                    | 596 |
| 14.2 Picture Format .....  | 598 |
| 14.3 Update project via U disk .....                                 | 599 |
| 14.4 Update recipe via U disk .....                                  | 600 |
| 14.5 Dial switch .....   | 601 |
| 15. Operation case (Supplement) .....                                | 603 |
| 15.1 A simple macroblock .....                                       | 603 |
| 15.2 Free Port Communication Protocol Case .....                     | 612 |
| 15.4 Recipe Case .....   | 626 |
| 15.5 Digital Alarm Login .....                                       | 629 |
| 15.6 Analog Alarm Login .....  | 635 |
| 15.7 Usb update PLC program .....                                    | 637 |
| 16. Remote .....   | 641 |
| 16.1 Remote profile .....  | 641 |
| 16.2 Remote configuration .....                                      | 641 |
| 16.3 VNC function .....  | 647 |
| 16.4 Remote case .....   | 648 |
| 17. FAQ & Solutions .....  | 654 |
| 18. Contact .....  | 659 |

---

# 1. HMI Specification

Welcome to SKTOOL online help that is meant to help you learn with the application of SKTOOL.

1. [Hardware Manual](#)

Introduce hardware structure of Samkoon HMI.

2. [Quick Start](#)

Introduce briefly features of the configuration software of Samkoon SK HMI, SKTOOL.

3. [Create a New Project](#)

Describe methods and steps for creating a project with SKTOOL.

4. [SKTOOL Configuration Guide](#)

Describe applications of other controls in SKTOOL.

5. [Script instruction](#)

Describe functions and applications of the SKTOOL script.

6. [SKTOOL simulation](#)

Introduce off-line simulation and online simulation functions of SKTOOL.

7. [System settings](#)

Describe the HMI settings of system parameters for setting HMI on SKTOOL.

8. [Reserved Registers of SKTOOL System](#)

Describe the registers reserved by the HMI system and their functions.

9. [Device drivers](#)

Introduce how to connect SK series HMI (Samkoon) and PLC.

10. [Contact information](#)

---

## 2. Preface

---

Thank you for choosing the SK series HMI products of Shenzhen Samkoon Technology Corporation Ltd. HMI is commonly known as the touch screen.

Shenzhen Samkoon Technology Corporation Ltd., concentrated in industrial visual and touchable control products --- research and development of human-machine interface core technology, is a national high-tech enterprise that is professional in developing, manufacturing and distributing the most advanced industrial products. After the accumulation of 12 years, Shenzhen Samkoon Technology, with the profound knowledge, attracts domestic and global related industries via its strong R & D and innovation capabilities, 100% completely independent intellectual property rights of core technology without any system basement as well as cost-effective advantage.

Samkoon SK series human-machine interface (HMI) is mainly applied in the field of industrial control to achieve visual and touchable control with its excellent performance in various industries, such as textile machinery, jigger machinery, plastic and rubber machinery, injection molding machinery, packaging machinery, ultrasonic equipment, electronic welding equipment, printing machinery, food machinery, medical machinery, woodworking machinery, lifting equipment, intelligent buildings, water treatment equipment, power systems, rail transit, cola system, petrochemical system, air conditioning industry, tire industry, measurement and control equipment, teaching instrument, advanced manufacturing system and equipment and other common equipment control industry. Having occupied the leading position in the domestic market, it obtains a common reputation by virtue of its excellent product quality, stable software running and powerful product features.

In view of requirements of various industrial control engineering design and construction, software development staffs of Samkoon are committed to the development and application of universal configuration software. In order to meet the world's vast industrial configuration needs, Samkoon launches "SKTOOL" to the whole China and even the world, a universal version of industrial automation configuration screen editing software.

SKTOOL is a universal industrial automation configuration software meant for the rapid construction and production of embedded computer monitoring system. Based on the development and application experience of configuration software, adopting the advanced computer software technology to construct the graphical interface of the user running system by employing the window as the unit, it provides users with solutions to practical project problems through animation display, alarm processing, process control and report output etc., by collecting and processing filed data. It has a wide range of applications in the field of automation.

In order to satisfy the users' needs to use SKTOOL, we have written this manual introducing details about system structure and features. Users can create own configuration only through simple operation so as to free users from cumbersome programming, making it handier for more users.

This manual explains how to operate the SK series configuration software SKTOOL. Please read it carefully to ensure correct applications.

When you cannot find a specific control in the help document, you can open the corresponding control in SKTOOL; click the "Help" button in the lower right corner of the control to jump to the corresponding help.

Due to the limited level of the author, errors or inappropriate places are inevitable. Criticism and correction are well welcome. If you need further information about SKTOOL configuration software and more technical support, please contact us through the following ways. Sincerely at your service.



---

**Shenzhen Samkoon Technology Corporation Ltd.**

**Address:** 3rd Floor, Block 1, Shenzhen software park, Middle Zone of High-tech,

**Nanshan District, Shenzhen, China.**

**Tel:** 0755-29419068

**Fax:** 0755-29455559

**E-Mail:** [samkoon@samkoon.com.cn](mailto:samkoon@samkoon.com.cn)

**Web:** <http://www.samkoon.com.cn>

---

## 3. Hardware Manual

---

This chapter summarizes the hardware part of SK series HMI, introduces the hardware dimension of products, including the models of SK-035F, SK-035U, SK-043F, SK-043H, SK-043U, SK-050H, SK-070F, SK-070G, SK-070M, SK-070H, SK-070F, SK-102H, SK-102C, SK-121F. Users can install them according to relevant dimensions. Refer to specific parameters for principle and composition of HMI, technical parameters of operating environment and correct method of wiring.

### Contents:

- [General](#)
- [Mounting dimensions](#)
- [HMI Structure](#)
- [Technical Parameters](#)
- [Wiring](#)

### 3.1 General

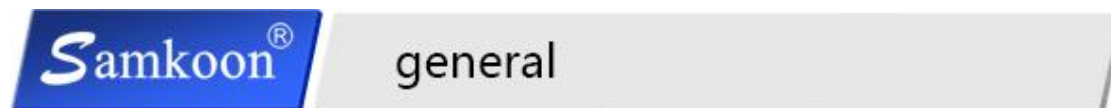

Samkoon SK series HMI is a high-quality human-machine interface product. The entire HMI integrates the CPU unit, input and output unit, display screen, memory and other module units. It can be widely used in control systems in all walks of life. The optimized design of software and hardware makes the product meet the needs of machine control in terms of touch accuracy and accuracy, as well as screen color.

SK series HMI has made great improvements on the previous basis. Compared with before, the startup speed is faster, the page switching speed is faster, the communication speed is also faster, and the HMI sensitivity is higher.

The following is the introduction of Samkoon SK series HMI:

#### 1. CPU Unit

Using ARM Cortex\_A8 processor, the operation speed is faster, the power consumption is smaller, and the operation is more stable.

#### 2. Touch panel display unit

Using a four-wire resistive touch panel, the touch precision is accurate, durable, and the touch life is long. The display is TFT LCD with 260,000 true color display.

### 3. Communication module

Adopt anti-interference, anti-high voltage, lightning strike design, enhance the accuracy and reliability of communication, support RS232, 485, 422 communication.

### 4. Storage unit

The FLASH which is kept after power off is used as ROM, and the access speed is fast.

### 5. Power Module

Adopt high-precision switching power supply, low power consumption.

### 6. Chip

What is used is TI's AM3352 chip based on ARM Cortex-A8 core. The chip has the following advantages: First, the chip is the one with the most complete public information in the history of TI; second, it is the one with the clearest product positioning, an industrial control MCU; third, it is the only MCU that integrates two MACs.

| model    | size (inch) | Resolution | color  | user memory | Aspect ratio | COM number   | CAN | RJ45 | WIFI | 4G | USB device port | USB programming interface |
|----------|-------------|------------|--------|-------------|--------------|--|-----|------|------|----|-----------------|---------------------------|
| SK-035FE | 3.5         | 320×240    | 262144 | 12M         | 4:3          | 1  | 0   | 0    | 0    | 0  | 0               | 1                         |
| SK-035UE | 3.5         | 320×240    | 262144 | 12M         | 4:3          | 1  | 0   | 0    | 0    | 0  | 0               | 1                         |
| SK-043FE | 4.3         | 480×272    | 262144 | 12M         | 16:9         | 1  | 0   | 0    | 0    | 0  | 1               | 1                         |
| SK-043HS | 4.3         | 480×272    | 262144 | 12M         | 16:9         | 1  | 0   | 1    | 0    | 0  | 1               | 1                         |
| SK-043HE | 4.3         | 480×272    | 262144 | 12M         | 16:9         | 1  | 0   | 0    | 0    | 0  | 1               | 1                         |
| SK-043UE | 4.3         | 480×272    | 262144 | 12M         | 16:9         | 1  | 0   | 0    | 0    | 0  | 1               | 1                         |
| SK-043TE | 4.3         | 480×272    | 262144 | 12M         | 16:9         | 1  | 0   | 0    | 0    | 0  | 1               | 1                         |
| SK-043QE | 4.3         | 480×272    | 262144 | 12M         | 16:9         | COM1:2<br>32<br>COM2:4<br>22/485                               | 0   | 0    | 0    | 0  | 1               | 1                         |
| SK-043QT | 4.3         | 480×272    | 262144 | 12M         | 16:9         | COM1:2<br>32<br>COM2:4<br>22/485<br>terminal<br>:COM2(<br>485) | 0   | 0    | 0    | 0  | 1               | 1                         |

|             |     |         |        |     |      |  |   |   |   |   |   |   |
|-------------|-----|---------|--------|-----|------|--|---|---|---|---|---|---|
| SK-050HS    | 5.0 | 800×480 | 262144 | 12M | 16:9 | 1  | 0 | 1 | 0 | 0 | 1 | 1 |
| SK-050HE    | 5.0 | 800×480 | 262144 | 12M | 16:9 | 1  | 0 | 0 | 0 | 0 | 1 | 1 |
| SK-057FE    | 5.7 | 640×480 | 262144 | 12M | 4:3  | 2  | 0 | 0 | 0 | 0 | 1 | 1 |
| SK-070FS    | 7.0 | 800×480 | 262144 | 12M | 16:9 | 2  | 0 | 1 | 0 | 0 | 1 | 1 |
| SK-070FE    | 7.0 | 800×480 | 262144 | 12M | 16:9 | 2  | 0 | 0 | 0 | 0 | 1 | 1 |
| SK-070HS    | 7.0 | 800×480 | 262144 | 12M | 16:9 | 2  | 0 | 1 | 0 | 0 | 1 | 1 |
| SK-070HE    | 7.0 | 800×480 | 262144 | 12M | 16:9 | 2  | 0 | 0 | 0 | 0 | 1 | 1 |
| SK-070GS    | 7.0 | 800×480 | 262144 | 12M | 16:9 | 2  | 0 | 1 | 0 | 0 | 1 | 1 |
| SK-070GE    | 7.0 | 800×480 | 262144 | 12M | 16:9 | 2  | 0 | 0 | 0 | 0 | 1 | 1 |
| SK-070GG    | 7.0 | 800×480 | 262144 | 12M | 16:9 | 2  | 1 | 1 | 0 | 1 | 1 | 1 |
| SK-070GW    | 7.0 | 800×480 | 262144 | 12M | 16:9 | 2  | 1 | 1 | 1 | 0 | 1 | 1 |
| SK-070MS    | 7.0 | 800×480 | 262144 | 12M | 16:9 | 2  | 0 | 1 | 0 | 0 | 1 | 1 |
| SK-070ME    | 7.0 | 800×480 | 262144 | 12M | 16:9 | 2  | 0 | 0 | 0 | 0 | 1 | 1 |
| SK-070MS v3 | 7.0 | 800×480 | 262144 | 12M | 16:9 | COM1:2<br>32/422/<br>485<br>COM2:4<br>85                       | 0 | 1 | 0 | 0 | 1 | 1 |
| SK-070ME v3 | 7.0 | 800×480 | 262144 | 12M | 16:9 | COM1:2<br>32/422/<br>485<br>COM2(o<br>ptional):<br>485         | 0 | 0 | 0 | 0 | 1 | 1 |
| SK-070MG    | 7.0 | 800×480 | 262144 | 12M | 16:9 | 2  | 1 | 1 | 0 | 1 | 1 | 1 |
| SK-070MW    | 7.0 | 800×480 | 262144 | 12M | 16:9 | 2  | 1 | 1 | 1 | 0 | 1 | 1 |
| SK-070QT    | 7.0 | 800×480 | 262144 | 12M | 16:9 | COM1:2<br>32<br>COM2:4<br>22/485<br>terminal<br>:COM3(<br>485) | 0 | 0 | 0 | 0 | 1 | 1 |
| SK-070QS    | 7.0 | 800×480 | 262144 | 12M | 16:9 | COM1:2   | 0 | 1 | 0 | 0 | 1 | 1 |

|             |      |          |        |     |      |  |   |   |   |   |   |   |
|-------------|------|----------|--------|-----|------|--|---|---|---|---|---|---|
|             |      |          |        |     |      | 32<br>COM2:4<br>22/485<br>terminal<br>:COM3(<br>485)           |   |   |   |   |   |   |
| SK-102HS    | 10.2 | 1024×600 | 262144 | 12M | 16:9 | 2  | 0 | 1 | 0 | 0 | 1 | 1 |
| SK-102HE    | 10.2 | 1024×600 | 262144 | 12M | 16:9 | 2  | 0 | 0 | 0 | 0 | 1 | 1 |
| SK-102HS v3 | 10.2 | 1024×600 | 262144 | 12M | 16:9 | COM1:2<br>32/422/<br>485<br>COM2:4<br>85                       | 0 | 1 | 0 | 0 | 1 | 1 |
| SK-102HE v3 | 10.2 | 1024×600 | 262144 | 12M | 16:9 | COM1:2<br>32/422/<br>485<br>COM2:4<br>85                       | 0 | 0 | 0 | 0 | 1 | 1 |
| SK-102CS    | 10.2 | 1024×600 | 262144 | 12M | 16:9 | 2  | 0 | 1 | 0 | 0 | 1 | 1 |
| SK-102CE    | 10.2 | 1024×600 | 262144 | 12M | 16:9 | 2  | 0 | 0 | 0 | 0 | 1 | 1 |
| SK-102CG    | 10.2 | 1024×600 | 262144 | 12M | 16:9 | 2  | 1 | 1 | 0 | 1 | 1 | 1 |
| SK-102CW    | 10.2 | 1024×600 | 262144 | 12M | 16:9 | 2  | 1 | 1 | 1 | 0 | 1 | 1 |
| SK-102QT    | 10.2 | 1024×600 | 262144 | 12M | 16:9 | COM1:2<br>32<br>COM2:4<br>22/485<br>terminal<br>:COM3(<br>485) | 0 | 0 | 0 | 0 | 1 | 1 |
| SK-102QS    | 10.2 | 1024×600 | 262144 | 12M | 16:9 | COM1:2<br>32<br>COM2:4<br>22/485<br>terminal<br>:COM3(<br>485) | 0 | 1 | 0 | 0 | 1 | 1 |

|              |      |           |        |     |      |  |   |   |   |   |   |   |
|--------------|------|-----------|--------|-----|------|--|---|---|---|---|---|---|
| SK-104FS     | 10.4 | 800×600   | 262144 | 12M | 4:3  | 2  | 0 | 1 | 0 | 0 | 1 | 1 |
| SK-104FE     | 10.4 | 800×600   | 262144 | 12M | 4:3  | 2  | 0 | 0 | 0 | 0 | 1 | 1 |
| SK-121FS     | 12.1 | 800×600   | 262144 | 12M | 4:3  | 2  | 0 | 1 | 0 | 0 | 1 | 1 |
| SK-121FE     | 12.1 | 800×600   | 262144 | 12M | 4:3  | 2  | 0 | 0 | 0 | 0 | 1 | 1 |
| SK-121FS 2.0 | 12.1 | 1024×768  | 262144 | 12M | 4:3  | 2  | 0 | 1 | 0 | 0 | 1 | 1 |
| SK-121FE 2.0 | 12.1 | 1024×768  | 262144 | 12M | 4:3  | 2  | 0 | 0 | 0 | 0 | 1 | 1 |
| SK-156QS     | 15.6 | 1920×1080 | 262144 | 12M | 16:9 | COM1:2<br>32/422/<br>485<br>COM2:4<br>85 | 0 | 1 | 0 | 0 | 1 | 0 |

Samkoon SK series HMI has the following models:



An example of the model SK-035FE shown in the figure above:

SK: Indicates the SK series of HMI,

035: indicates the size (3.5 inches),

F: Indicates the model number, and there are H, M, G for the model number

E: Indicates that the HMI is an economical type, if it is S, it means that the HMI is a standard type, G means a model with 4G, and W means a model with WIFI

Samkoon SK series HMI is an open man-machine interface product that provides a standard serial interface to connect with other devices. The supported communication method is mainly serial communication, which supports communication with mainstream PLCs on the market today, such as Samkoon FGs, Mitsubishi, Siemens, Omron, Modicon and so on. At the same time, communication drivers can be developed according

to customer requirements.

The configuration software of Samkoon SK series HMI is SKTOOL. SKTOOL provides users with functions such as screen configuration, drive settings, and controls.

## 3.2 Mounting dimensions

---

The following is detailed introduction to mounting dimensions of SK HMI. Please install HMI in accordance with fixed mounting dimensions to avoid damaging products.

The table below lists mounting dimensions of all SK series products:

|       |                        |
|-------|------------------------|
| Model | <a href="#">SK-035</a> |
|       | <a href="#">SK-043</a> |
|       | <a href="#">SK-050</a> |
|       | <a href="#">SK-057</a> |
|       | <a href="#">SK-070</a> |
|       | <a href="#">SK-102</a> |
|       | <a href="#">SK-104</a> |
|       | <a href="#">SK-121</a> |

### 3.2.1 SK-035

Dimensions: 135×89×39

Installation hole size: 123×80

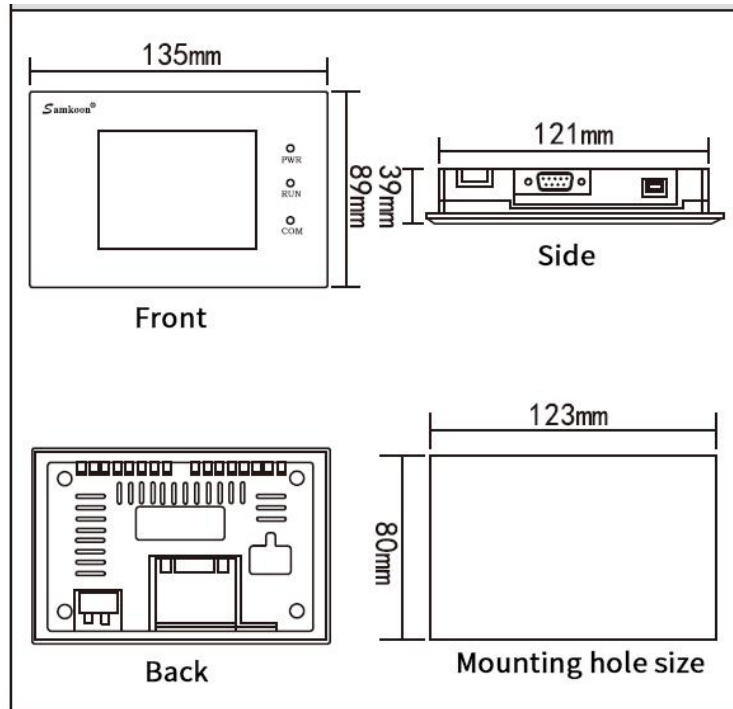

SK-035UE model product size (mm)

Dimensions: 96×81×47

Installation hole size: 92×77

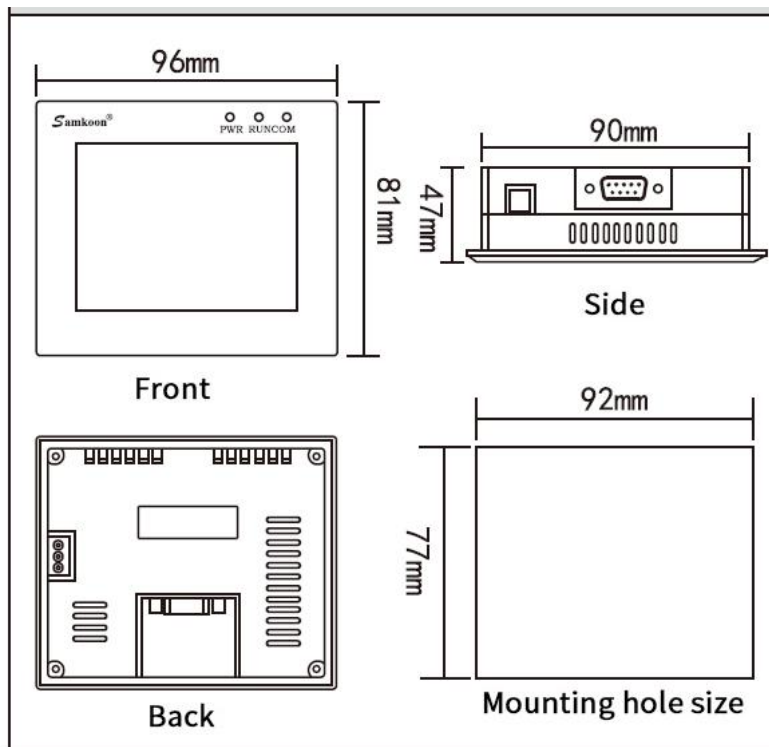

### 3.2.2 SK-043

Dimensions: 150×93×39



Installation hole size: 141×84

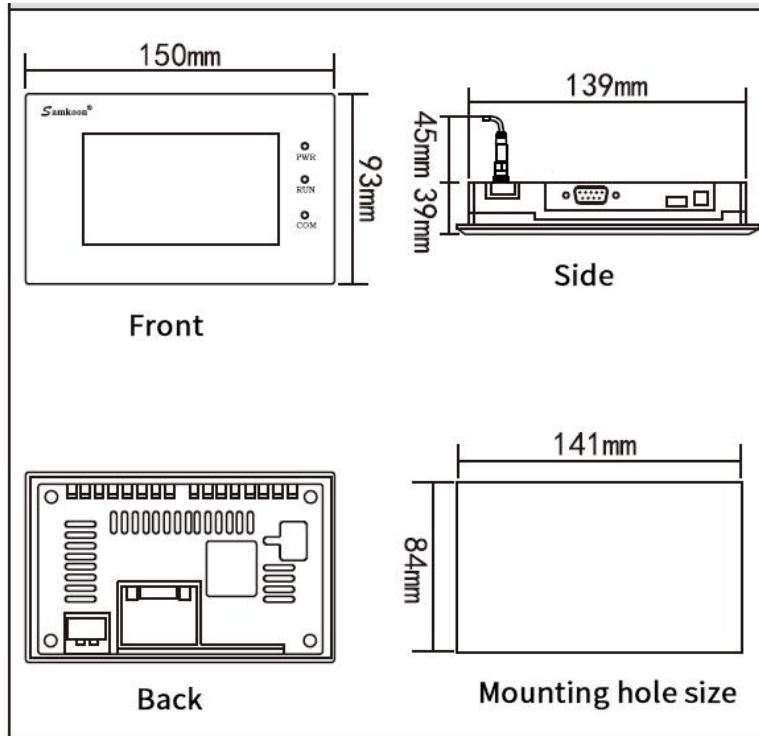

Product size (mm) of SK-043H model:

Dimensions: 173×95×39

Installation hole size: 163×85

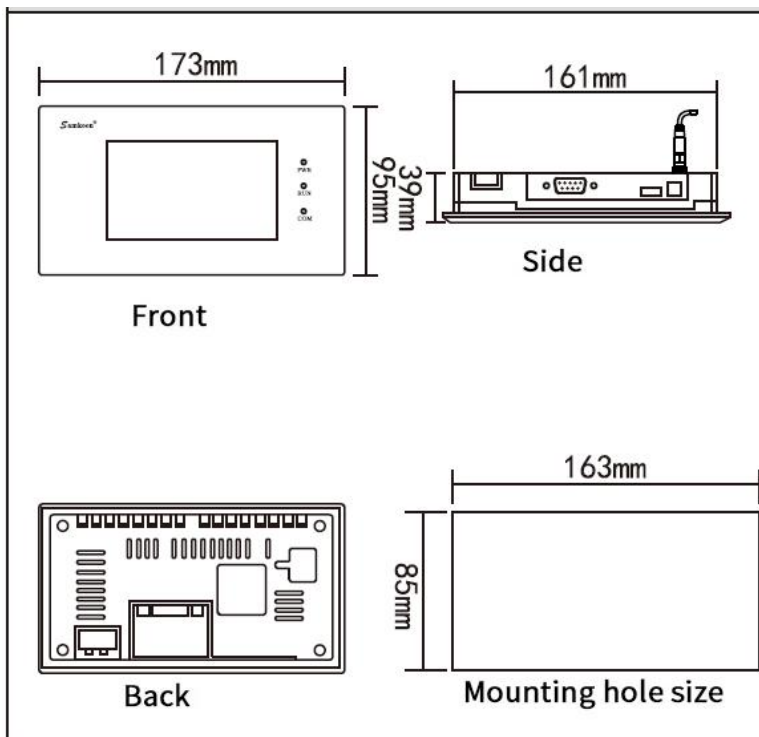

Product size of SK-043U model (mm):

Dimensions: 138×86×38

Installation hole size: 132×80

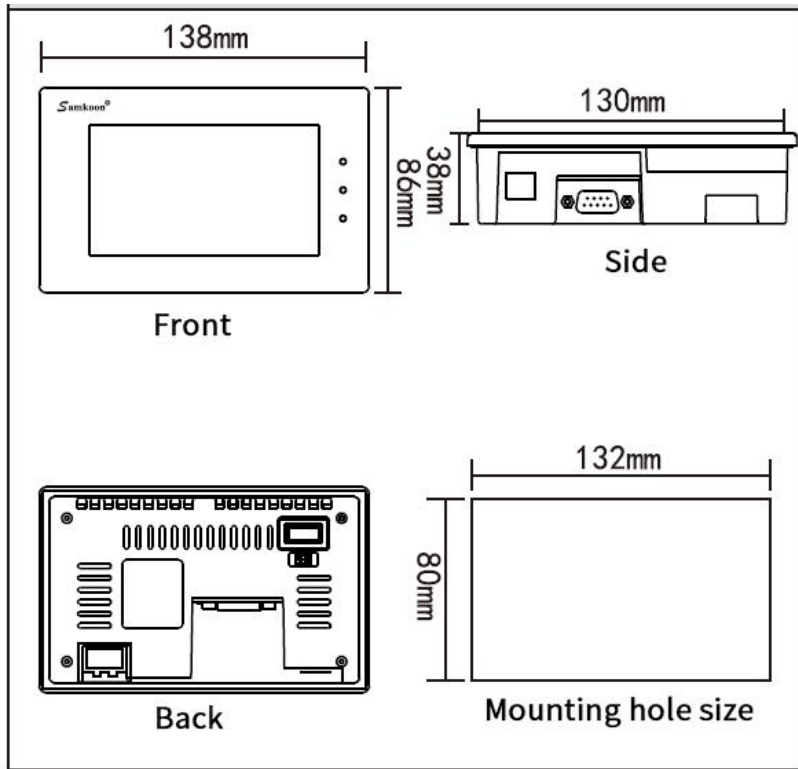

Product size (mm) of SK-043T model:

Dimensions: 139x86x38

Installation hole size: 132x80

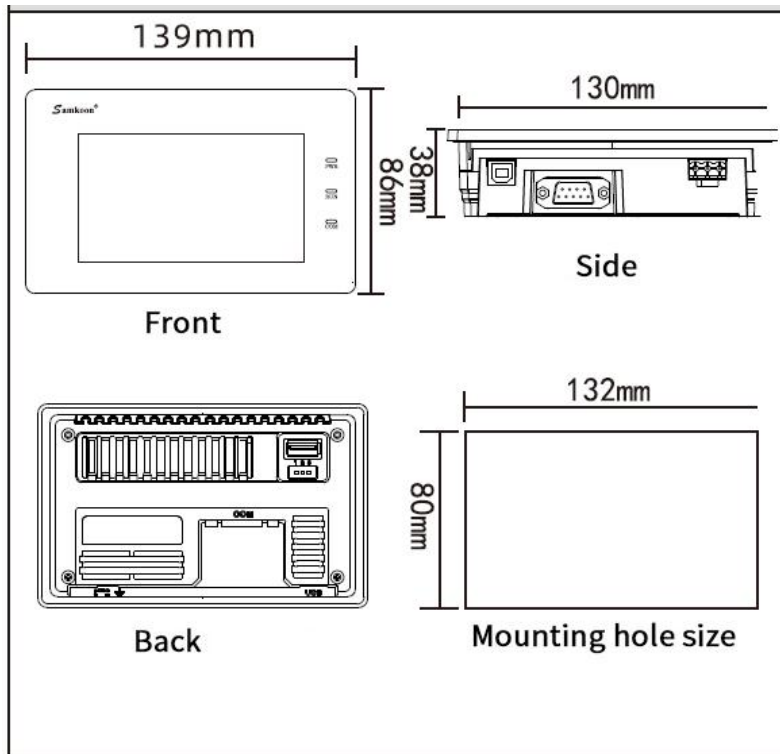

Product size (mm) of SK-043Q model:

Dimensions: 139x86x31

Installation hole size: 132×80

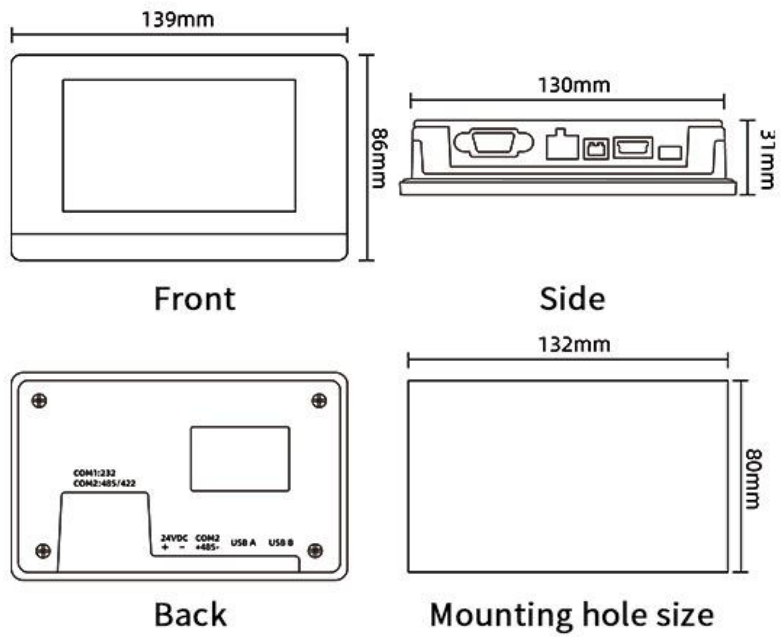

### 3.2.3 SK-050

Dimensions: 165×103×39

Installation hole size: 157×95

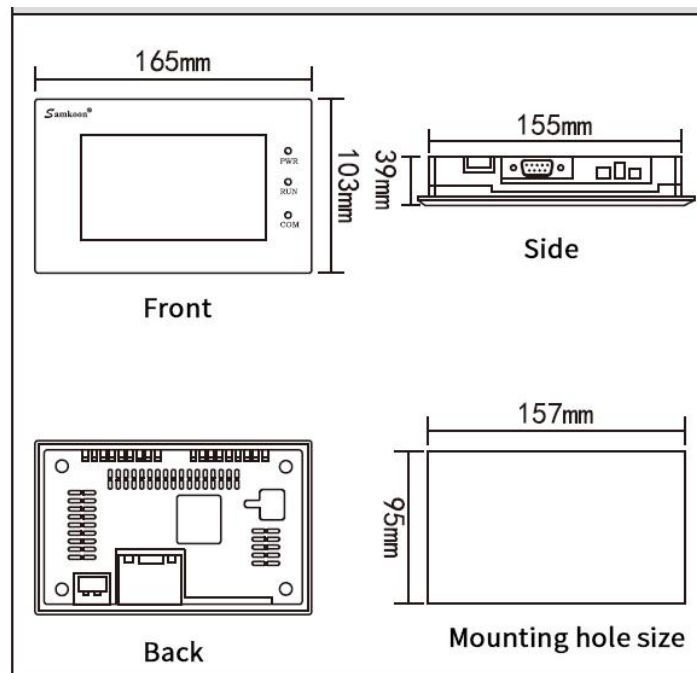

### 3.2.4 SK-057

Dimensions: 177x140x40

Installation hole size: 163x133

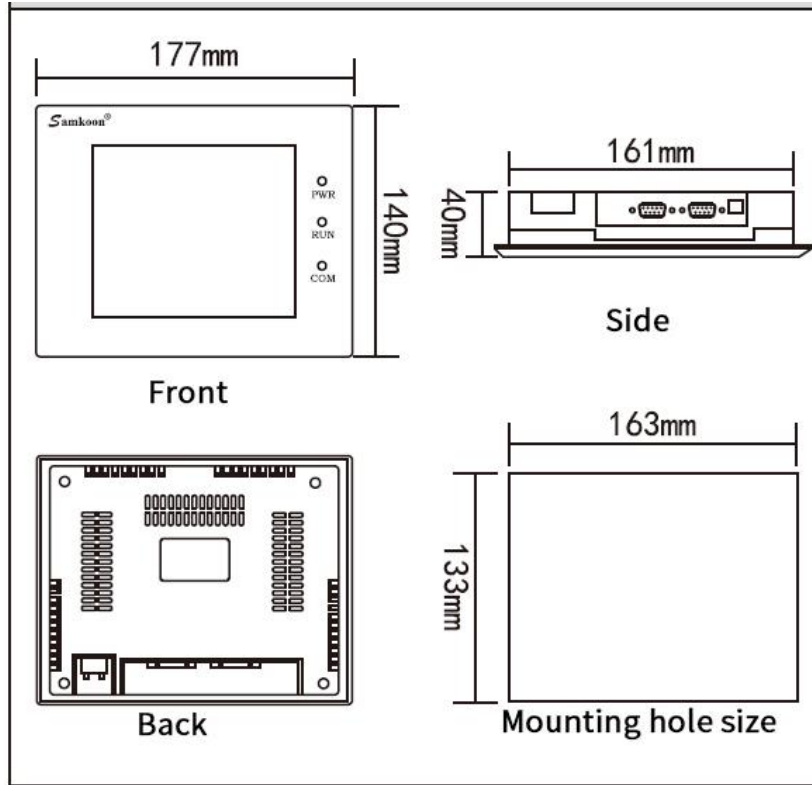

### 3.2.5 SK-070

Dimensions: 227x153x40

Installation hole size: 210x144

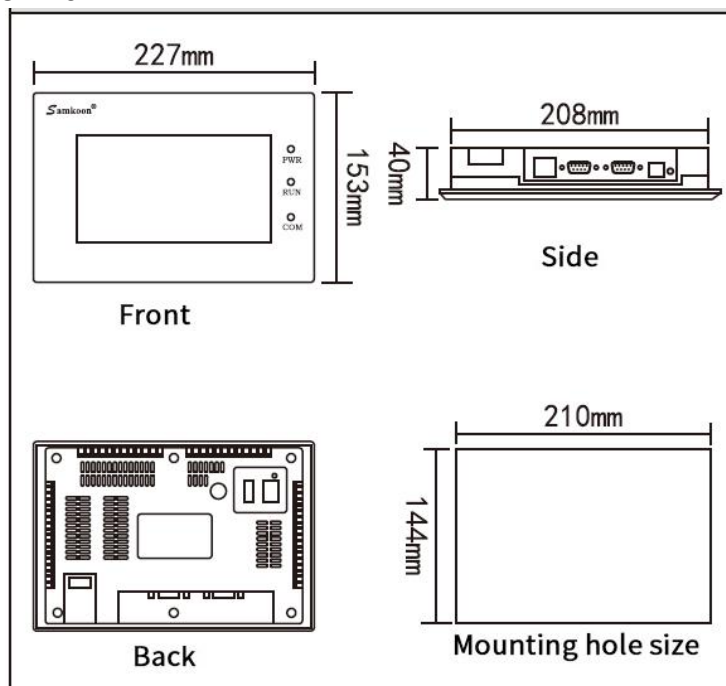

Product size (mm) of SK-070H model:

Dimensions: 205×145×38

Installation hole size: 192×138

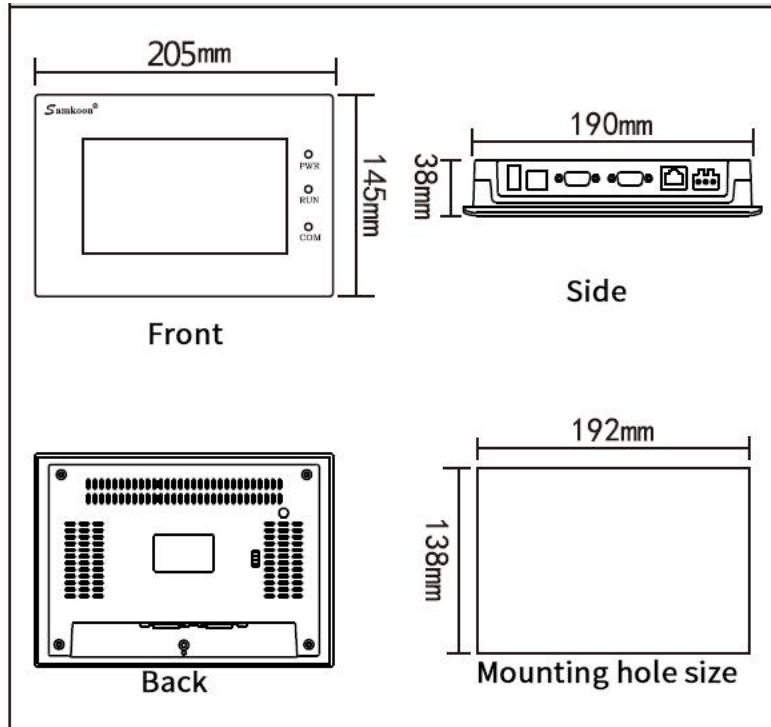

Product size of SK-070G model (mm):

Dimensions: 225×153×40

Installation hole size: 210×144

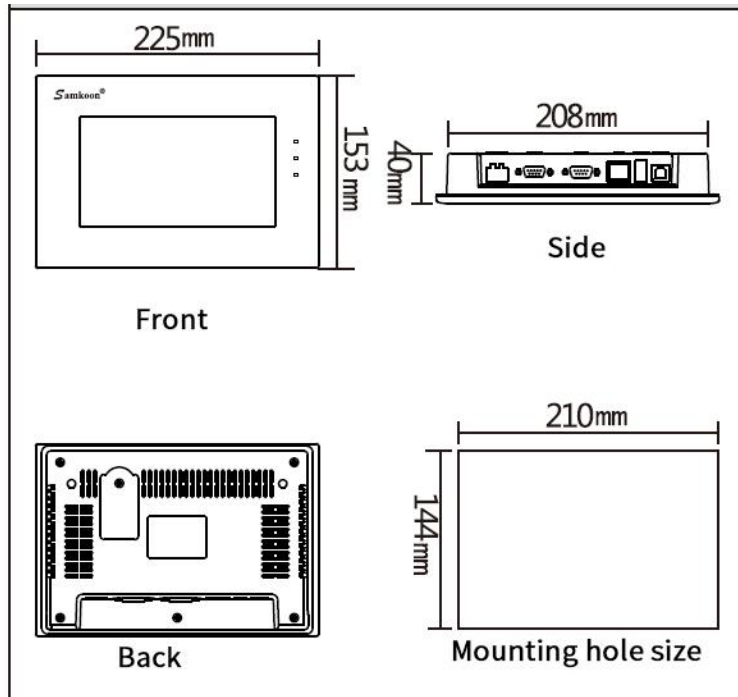

Product size (mm) of SK-070M model:

Dimensions: 205×145×40

Installation hole size: 192×138

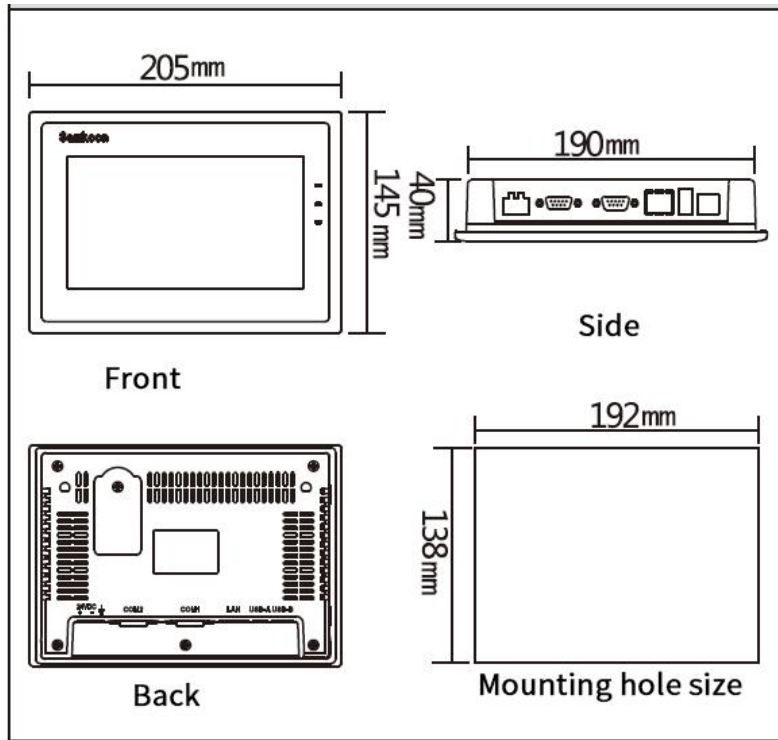

Note: SK-070ME/MS v3 version COM2 only supports 485

Product size (mm) of SK-070Q model:

Dimensions: 203×145×35

Installation hole size: 192×138

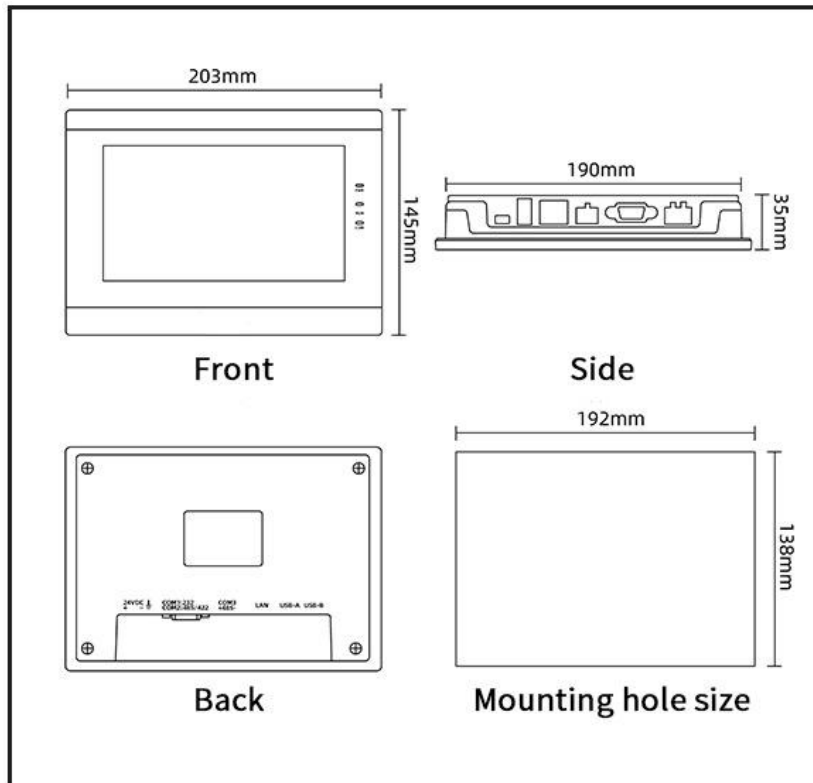

### 3.2.6 SK-102

Dimensions: 275×211×44

Installation hole size: 259×201

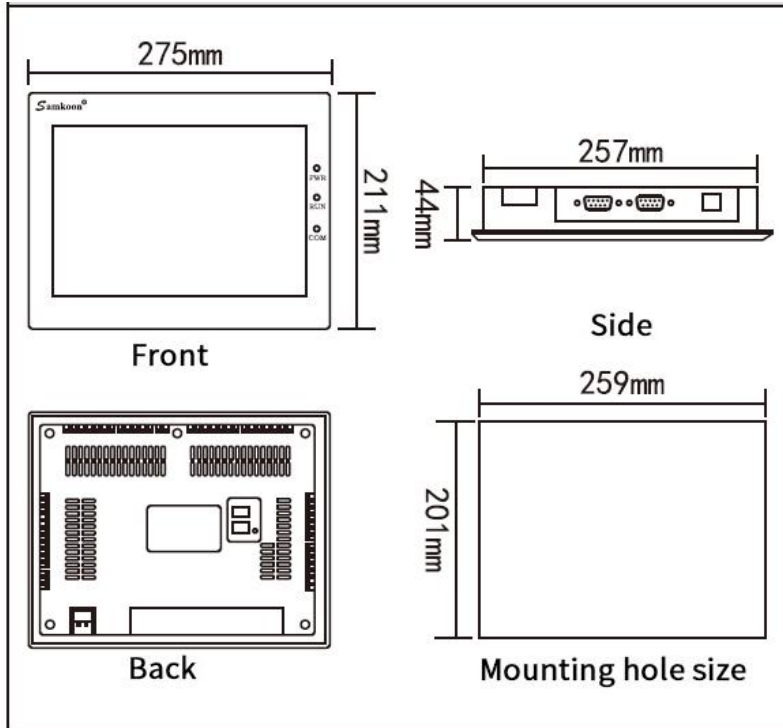

Product size of SK-102C model (mm):

Dimensions: 274×180×40

Installation hole size: 255×167

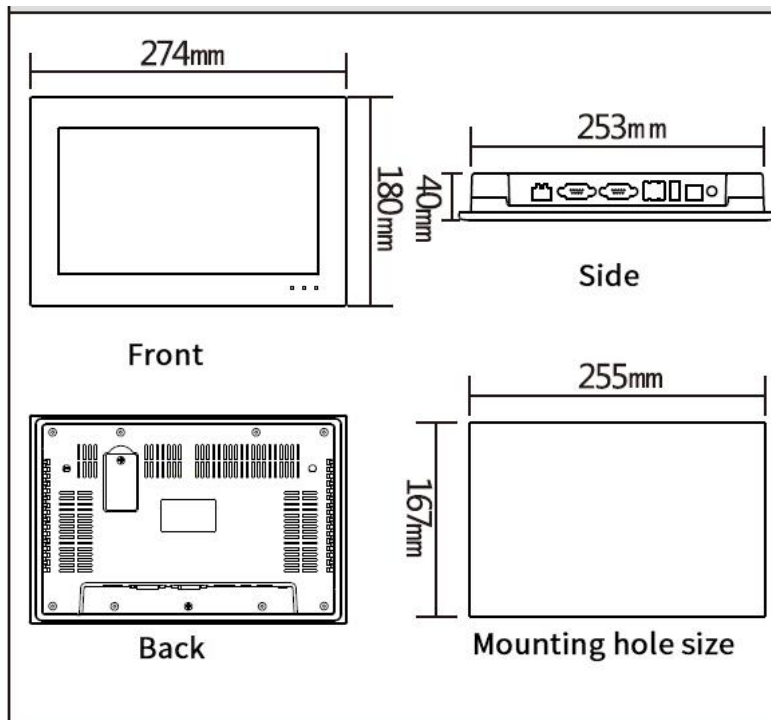

Product dimensions of SK-102H v3 model (mm):

Dimensions: 273×211×39

Installation hole size: 259×201

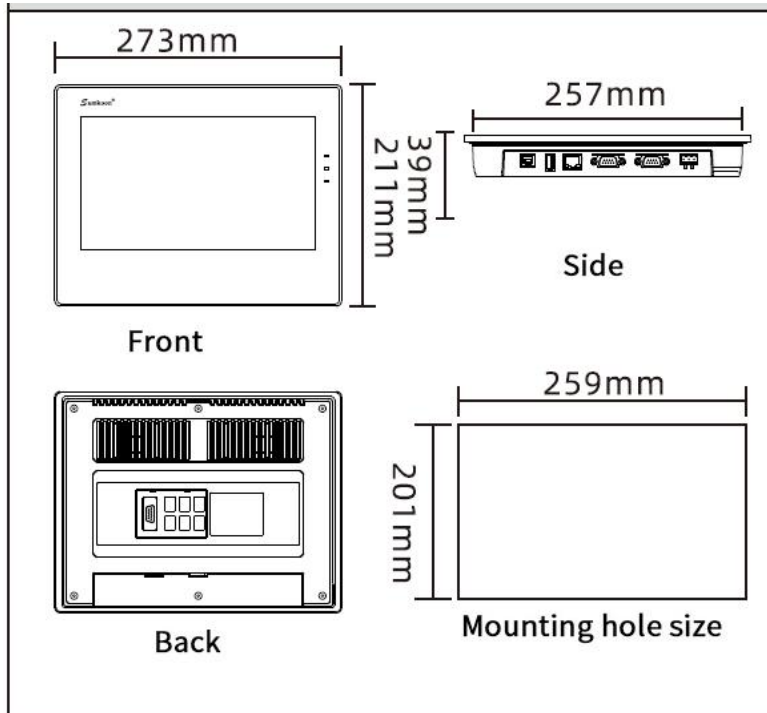

Note: SK-102HE/HS v3 version COM2 only supports 485

Product size (mm) of SK-102Q model:

Dimensions: 273×211×44

Installation hole size: 259×201

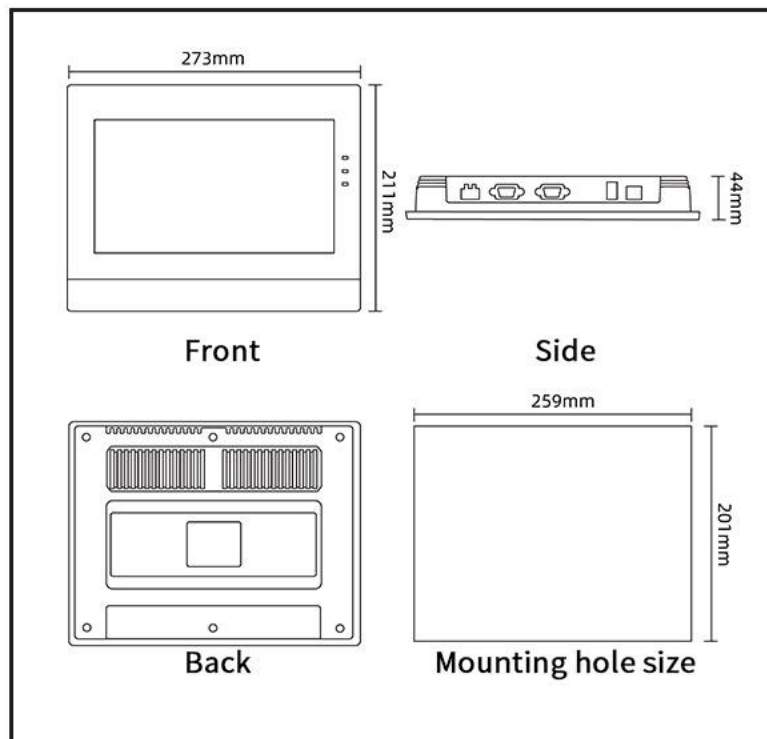

### 3.2.7 SK-104

Dimensions: 312×225×55



Installation hole size: 285×212

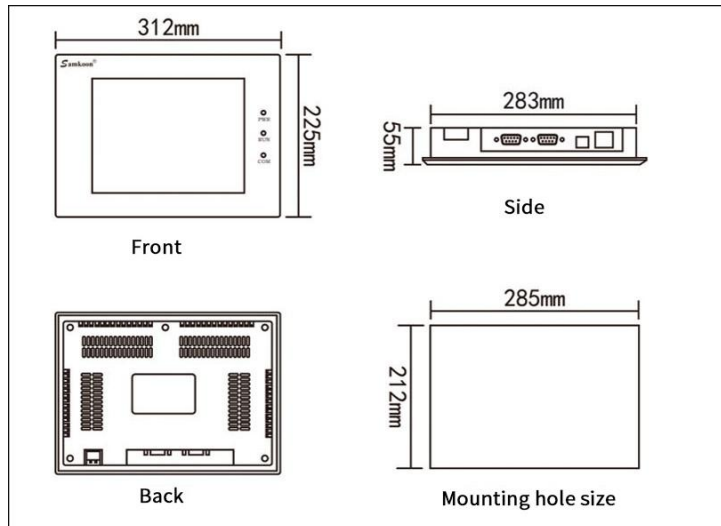

### 3.2.8 SK-121

Dimensions: 340×256×54

Installation hole size: 330×246

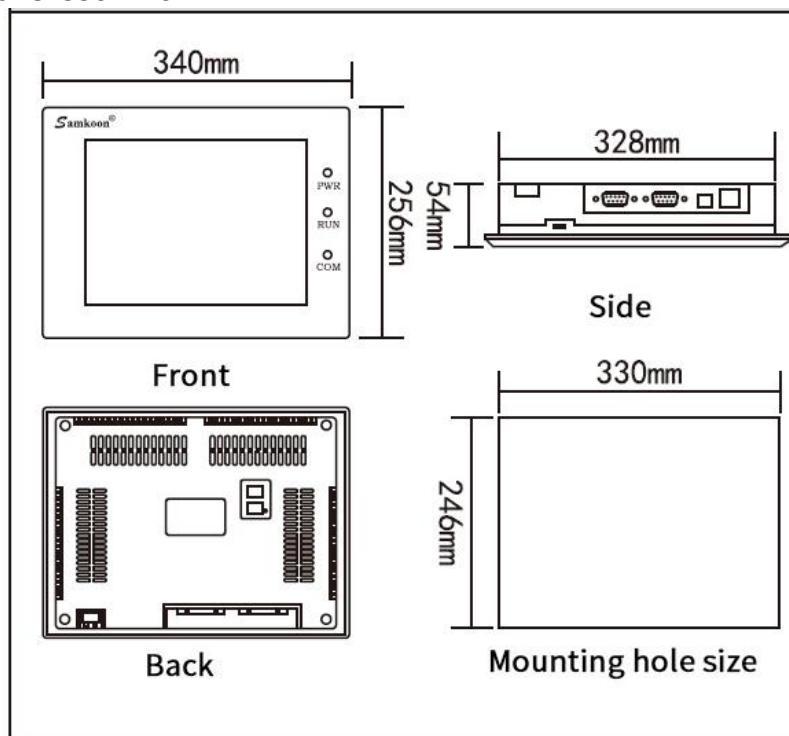

## 3.3 HMI Structure

The entire structure of Samkoon SK series HMI consists of display area, indicator light, power interface and communication ports. Color of all models accords to the industrial design standard, with the feature of soiling resistance so as to work in harsh factory environment, and indicator lights on the front panel meant to check the equipment status. Power interface and communication ports are located at the bottom of the HMI, which meets the design criteria.

Figure 1-11 shows the structure of HMI.

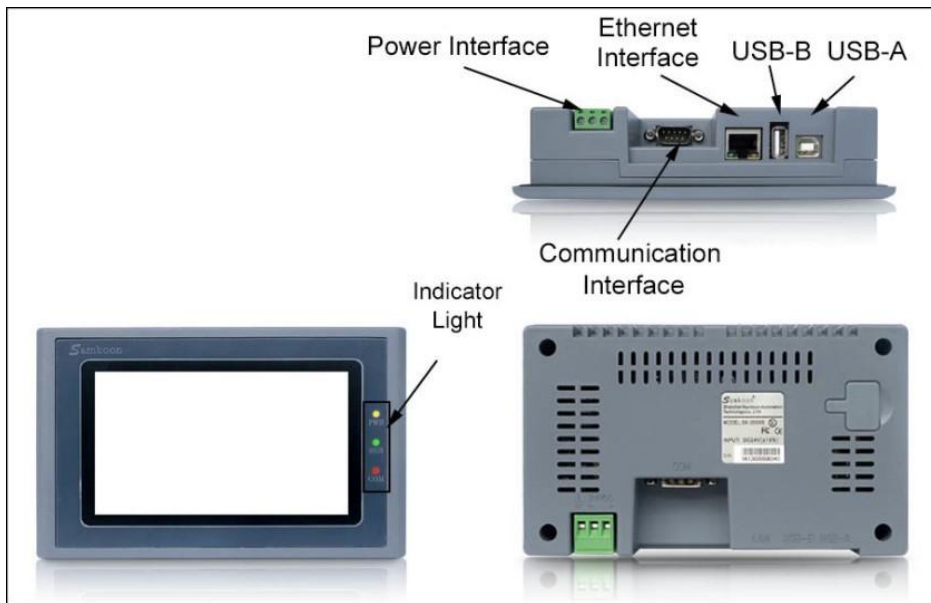

Figure 1-11 Structure

- Ethernet port: Connection of Ethernet cable
- USB-B: Insert the U disk
- USB-A: Connect with PC; download the configuration file from PC to HMI
- Communication Interface: Communicate with PLC

### 3.3.1 Power Interface

The power interface of the Samkoon SK series HMI locates in the back panel. With DC24V power supply ( $\pm 15\%$ ), it shields effectively against interference, enhancing the anti-disturbance performance of the entire system. Figure 1-12 is a view of power interface:



Figure 1-12 power interface

### 3.3.2 Front panel

---

Figure 1-13 is a view of front panel, including display screen and indicator lights:

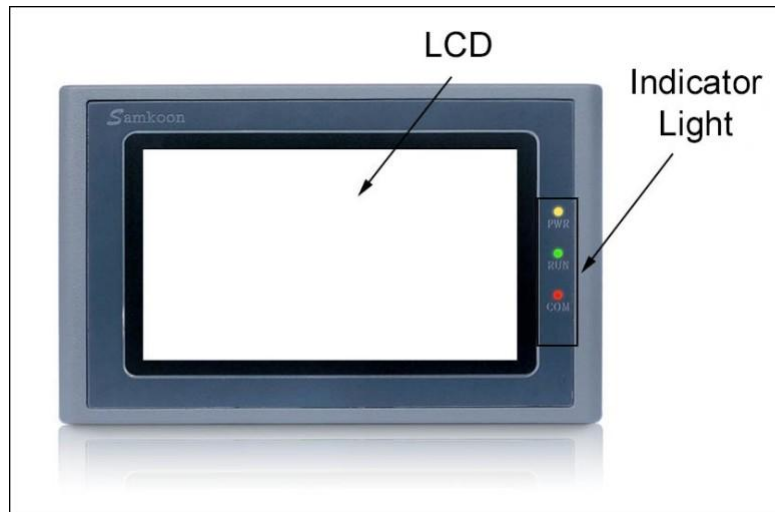

Figure 1-13 SK series front panel

### 3.3.3 Communication port

---

Communication ports of HMI are located in the bottom panel. Models of SK-121F , SK-102H , SK-102C , SK-070G, SK-070M, SK-070H, SK-070F provide two standard serial communication ports while those SK-035F, SK-035U, SK-043F, SK-043H, SK-043U, SK-050H adopting a 9-core D-type interface for connection to a PLC or other controller and also for communication, provide one standard serial communication port.

When using a shielded cable, RS232 communication distance shall not go over 15 meters. For connection to the computer, it has a USB communication interface used for downloading configuration (data transmission). The transmission rate can be up to 10Mbps. Definition of communication interface differs if it is connected to different PLC (Please inform us the type of PLC to be connected when ordering for facilitating the distribution of communication cables).

The model in Figure 1-14 is equipped with double serial and USB-A port, the model in Figure 1-15 is equipped with single serial and USB-A port:

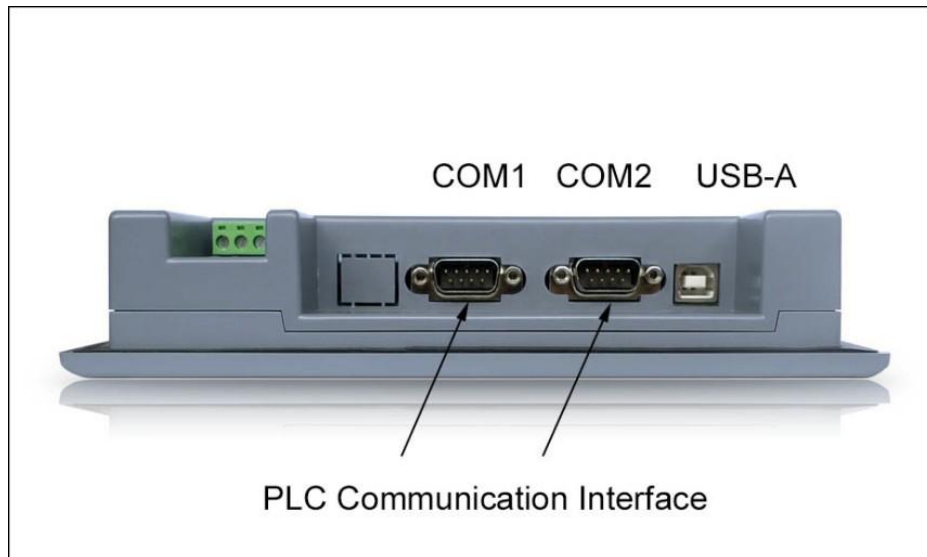

Figure 1-14 Side panels of SK (double serial)

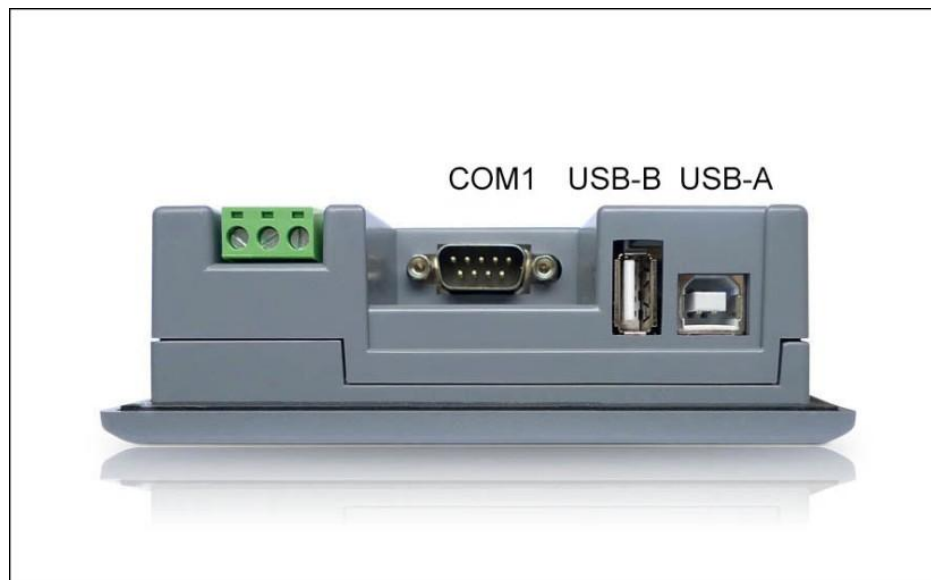

Figure 1-15 Side panels of SK (single serial)

### 3.3.4 Pin

---

Pareto diagram of 9-pin communication port, as figure 1-16:

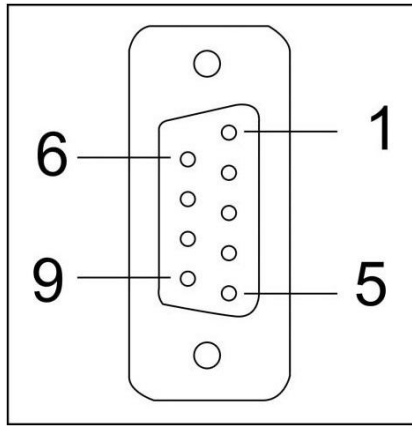

Figure 1-16 9-pin communication port

This port is used to connect PLC or other controllers with RS232 / RS422 / RS485 communication port

| Pin | RS232 | RS422 | RS485 |
|-----|-------|-------|-------|
| 1   |       |       |       |
| 2   | RX    |       |       |
| 3   | TX    |       |       |
| 4   |       |       |       |
| 5   | GND   |       |       |
| 6   |       | RX-   |       |
| 7   |       | RX+   |       |
| 8   |       | TX-   | B     |
| 9   |       | TX+   | A     |

### 3.3.5 Running Indicator Lights

Indicator lights of the touch screen consist of three LEDs, including Power (PWR), Run (RUN) and communications (COM), just as shown in Figure 1-17.



Figure 1-17 SK series Running Indicator Lights

PWR turns green when it is powered;

RUN turns yellow if CPU works normally while it lights out if CPU fails;

COM turns yellow when the touch screen is connected to PLC.

Table 1-1 shows the display states of the 3 LED indicator lights on different working state.

| Device state                                    | Green LED (PWR) | Yellow LED (RUN) | Yellow LED (COM) |
|---|-----------------|------------------|------------------|
| No power supply                                 | ○               | ○                | ○                |
| Power on  | ●               |                  |                  |
| CPU running                                     | ●               | ●                |                  |
| Communication with connected device             | ●               | ●                | ※                |
| ○: LED is OFF; ●: LED is ON; ※: LED is flashing |                 |                  |                  |

Table 1-1

### 3.4 Technical Parameters

This table lists major technical parameters of SK series products:

|       |                        |
|-------|------------------------|
| Model | <a href="#">SK-035</a> |
|       | <a href="#">SK-043</a> |
|       | <a href="#">SK-050</a> |
|       | <a href="#">SK-057</a> |
|       | <a href="#">SK-070</a> |
|       | <a href="#">SK-102</a> |
|       | <a href="#">SK-104</a> |

- Support up to ten formulas;
- Support up to 512 items of data transmission;
- Support up to 4sets of historical data collectors;
- Support up to ten sets of digital alarm;
- Support up to ten sets of analog alarm;
- Maximum number of screens and controls depends on the memory they occupy.

### 3.4.1 SK-035

|                              |   |
|------------------------------|---|
| network port                 | none  |
| USB programming interface    | 1   |
| USB device port              | none  |
| COM port                     | COM1: RS232, RS422, RS485                   |
| Display specifications       | 3.5" (L:W = 4:3)                            |
| Resolution                   | 320×240                                     |
| brightness                   | 350cd/m <sup>2</sup>                        |
| color                        | 262,144 colors                              |
| Contrast                     | 400 : 1                                     |
| Backlight life               | 50,000 hours                                |
| touchpad                     | 4-wire high precision touchpad              |
| RAM                          | 128M  |
| Power supply                 | DC24V(±15%)                                 |
| Power consumption            | 3W  |
| CE certification             | Complies with EN50022 and EN50024 standards |
| FCC Compatibility            | Complies with FCC, Class A                  |
| Pressure test                | 1000V AC, 1 minute                          |
| Protection class             | IP65 (front panel)                          |
| Working temperature          | 0~55℃ (no freezing)                         |
| Working environment humidity | 5~95%RH (non-condensing)                    |
| shell plastic                | Engineering plastic ABS+PC                  |

|            |               |              |
|------------|---------------|--------------|
| Dimensions | 135×89×39(mm) | 96x81x47(mm) |
| Hole Size  | 123×80(mm)    | 92x77(mm)    |
| weight     | About 0.2kg   |              |

### 3.4.2 SK-043

|                           |   |      |                          |  |
|---------------------------|---|------|--------------------------|--|
| network port              | none  | none | 1                        | none   |
| USB programming interface | 1   |      |                          |  |
| USB device port           | 1   |      |                          |  |
| COM port                  | COM1:RS232,RS422,RS485                      |      | COM1:232<br>COM2:422/485 | COM1:232<br>COM2:422/485<br>terminal:COM2(485) |
| CAN port                  | 1   | none |                          |  |
| Display specifications    | 4.3"(L:W = 16:9)                            |      |                          |  |
| Resolution                | 480×272                                     |      |                          |  |
| brightness                | 400cd/m <sup>2</sup>                        |      |                          |  |
| color                     | 262,144 colors                              |      |                          |  |
| Contrast                  | 400 : 1                                     |      |                          |  |
| Backlight life            | 50,000 hours                                |      |                          |  |
| touchpad                  | 4-wire high precision touchpad              |      |                          |  |
| RAM                       | 128M  |      |                          |  |
| Power supply              | DC24V(±15%)                                 |      | (DC12~24V)±15%           |  |
| Power consumption         | 3W  |      |                          |  |
| CE certification          | Complies with EN50022 and EN50024 standards |      |                          |  |
| FCC Compatibility         | omplies with FCC, Class A                   |      |                          |  |
| Pressure test             | 1000V AC,1minute                            |      |                          |  |
| Protection class          | IP65 ( front panel )                        |      |                          |  |
| Working temperature       | 0~55℃ ( no freezing )                       |      | -20~55℃ ( nonefreezing ) |  |
| Working                   | 5~95%RH ( non-condensing )                  |      |                          |  |



|                      |                            |               |               |               |
|----------------------|----------------------------|---------------|---------------|---------------|
| environment humidity |                            |               |               |               |
| shell plastic        | Engineering plastic ABS+PC |               |               |               |
| Dimensions           | 150×93×39(mm)              | 173×95×39(mm) | 138×86×38(mm) | 139×86×31(mm) |
| Hole Size            | 141×84(mm)                 | 163×85(mm)    | 132×80(mm)    | 132×80(mm)    |
| weight               | About 0.27kg               |               |               |               |

### 3.4.3 SK-050

|                              |   |      |
|------------------------------|---|------|
| network port                 | 1   | none |
| USB programming interface    | 1   |      |
| USB device port              | 1   |      |
| COM port                     | COM1: RS232, RS422, RS485                   |      |
| Display specifications       | 5.0" (L:W = 16:9)                           |      |
| Resolution                   | 800×480                                     |      |
| brightness                   | 350cd/m <sup>2</sup>                        |      |
| color                        | 262,144 colors                              |      |
| Contrast                     | 400 : 1                                     |      |
| Backlight life               | 50,000 hours                                |      |
| touchpad                     | 4-wire high precision touchpad              |      |
| RAM                          | 128M  |      |
| Power supply                 | DC24V(±15%)                                 |      |
| Power consumption            | 4W  |      |
| CE certification             | Complies with EN50022 and EN50024 standards |      |
| FCC Compatibility            | Complies with FCC, Class A                  |      |
| Pressure test                | 1000V AC, 1 minute                          |      |
| Protection class             | IP65 (front panel)                          |      |
| Working temperature          | 0~55°C (no freezing)                        |      |
| Working environment humidity | 5~95%RH (non-condensing)                    |      |
| shell plastic                | Engineering plastic ABS+PC                  |      |
| Dimensions                   | 165×103×39(mm)                              |      |
| Hole Size                    | 157×95(mm)                                  |      |
| weight                       | About 0.33kg                                |      |

### 3.4.4 SK-057

|                              |   |
|------------------------------|---|
| network port                 | none  |
| USB programming interface    | 1   |
| USB device port              | 1   |
| COM port                     | COM1/COM2: RS232, RS422, RS485              |
| Display specifications       | 5.7" (L:W = 4:3)                            |
| Resolution                   | 640×480                                     |
| brightness                   | 400cd/m <sup>2</sup>                        |
| color                        | 262,144 colors                              |
| Contrast                     | 400 : 1                                     |
| Backlight life               | 50,000 hours                                |
| touchpad                     | 4-wire high precision touchpad              |
| RAM                          | 128M  |
| Power supply                 | DC24V(±15%)                                 |
| Power consumption            | 6W  |
| CE certification             | Complies with EN50022 and EN50024 standards |
| FCC Compatibility            | Complies with FCC, Class A                  |
| Pressure test                | 1000VAC, 1 minute                           |
| Protection class             | IP65 (front panel)                          |
| Working temperature          | 0~55℃ (no freezing)                         |
| Working environment humidity | 5~95%RH (non-condensing)                    |
| shell plastic                | Engineering plastic ABS+PC                  |
| Dimensions                   | 177x140x40                                  |
| Hole Size                    | 163x133                                     |
| weight                       | About 0.51kg                                |

### 3.4.5 SK-070

|                           |                             |      |   |      |   |      |   |
|---------------------------|-----------------------------|------|---|------|---|------|---|
| network port              | 1                           | none | 1 | none | 1 | none | 1 |
| USB programming interface | 1                           |      |   |      |   |      |   |
| USB device port           | 1                           |      |   |      |   |      |   |
| COM port                  | COM1/COM2:RS232,RS422,RS485 |      |   |      |   |      |   |
| CAN port                  | none                        |      |   |      |   |      | 1 |

|                              |   |               |               |
|------------------------------|---|---------------|---------------|
| 4G                           | none  | 1             | none          |
| WIFI                         | none  | none          | 1             |
| Display specifications       | 7"(L:W = 16:9)                              |               |               |
| Resolution                   | 800×480                                     |               |               |
| brightness                   | 450cd/m <sup>2</sup>                        |               |               |
| color                        | 262,144 colors                              |               |               |
| Contrast                     | 400:1                                       |               |               |
| Backlight life               | 50,000 小时                                   |               |               |
| touchpad                     | 4-wire high precision touchpad              |               |               |
| RAM                          | 128M  |               |               |
| Power supply                 | DC24 V (±15%)                               |               |               |
| Power consumption            | 5W  |               |               |
| CE certification             | Complies with EN50022 and EN50024 standards |               |               |
| FCC Compatibility            | omplies with FCC, Class A                   |               |               |
| Pressure test                | 1000V AC,1minute                            |               |               |
| Protection class             | IP65 (front panel)                          |               |               |
| Working temperature          | 0~55℃ (no freezing)                         |               |               |
| Working environment humidity | 5~95%RH (non-condensing)                    |               |               |
| shell plastic                | Engineering plasticABS+PC                   |               |               |
| Dimensions                   | 227×153×40 mm                               | 203×145×40 mm | 225×153×40 mm |
| Hole Size                    | 210×144 mm                                  | 192×138 mm    | 210×144mm     |
| weight                       | About 0.27kg                                |               | About 0.7kg   |

| The main technical parameters |                             |          |          |          |                  |                |          |          |
|-------------------------------|-----------------------------|----------|----------|----------|------------------|----------------|----------|----------|
| model                         | SK-070MS                    | SK-070ME | SK-070MG | SK-070MW | SK-070MS<br>v3   | SK-070ME<br>v3 | SK-070QT | SK-070QS |
| network port                  | 1                           | none     | 1        |          |                  | none           |          | 1        |
| USB programming interface     | 1                           |          |          |          |                  |                |          |          |
| USB device port               | 1                           |          |          |          |                  |                |          |          |
| COM port                      | COM1/COM2:RS232,RS422,RS485 |          |          |          | COM1;232/422/485 |                | COM1:232 |          |

|                              |   |   |                    |                                    |
|------------------------------|---|---|--------------------|------------------------------------|
|                              |   |   | COM2:485(optional) | COM2:422/485<br>terminal:COM3(485) |
| CAN port                     | none  | 1 |                    | none                               |
| 4G                           | none  | 1 | none               |                                    |
| WIFI                         | none  |   | 1                  | none                               |
| Display specifications       | 7"(L:W = 16:9)                              |   |                    |                                    |
| Resolution                   | 800×480                                     |   |                    |                                    |
| brightness                   | 450cd/m <sup>2</sup>                        |   |                    |                                    |
| color                        | 262,144colors                               |   |                    |                                    |
| Contrast                     | 400:1                                       |   |                    |                                    |
| Backlight life               | 50,000 hours                                |   |                    |                                    |
| touchpad                     | 4-wire high precision touchpad              |   |                    |                                    |
| RAM                          | 128M  |   |                    |                                    |
| Power supply                 | DC24 V (±15%)                               |   |                    | (DC12~24V)±15%                     |
| Power consumption            | 5W  |   |                    | 4W                                 |
| CE certification             | Complies with EN50022 and EN50024 standards |   |                    |                                    |
| FCC Compatibility            | omplies with FCC, Class A                   |   |                    |                                    |
| Pressure test                | 1000V AC,1minute                            |   |                    |                                    |
| Protection class             | IP65 ( front panel )                        |   |                    |                                    |
| Working temperature          | 0~55℃ ( no freezing )                       |   |                    | -20 ~ 55℃ ( no freezing )          |
| Working environment humidity | 5~95%RH ( non-condensing )                  |   |                    |                                    |
| shell plastic                | Engineering plasticABS+PC                   |   |                    |                                    |
| Dimensions                   | 205×145×40 mm                               |   |                    | 203×145×35 mm                      |
| Hole Size                    | 192×138 mm                                  |   |                    |                                    |
| weight                       | About 0.7kg                                 |   |                    |                                    |

### 3.4.6 SK-102

|                              |   |                |              |                |                |  |   |
|------------------------------|---|----------------|--------------|----------------|----------------|--|---|
| network port                 | 1   | none           | 1            | none           | 1              | none   | 1 |
| USB programming interface    | 1   |                |              |                |                |  |   |
| USB device port              | 1   |                |              |                |                |  |   |
| COM port                     | COM1/COM2:RS232,RS422,RS485                 |                |              |                |                | COM1:232<br>COM2:422/485<br>terminal:COM3(485) |   |
| CAN port                     | 0   |                | 1            |                | 0              |  |   |
| 4G                           | none  |                | 1            | none           | none           |  |   |
| WIFI                         | none  |                | none         | 1              | none           |  |   |
| Display specifications       | 10.2"(L:W = 16:9)                           |                |              |                |                |  |   |
| Resolution                   | 1024×600                                    |                |              |                |                |  |   |
| brightness                   | 500cd/m <sup>2</sup>                        |                |              |                |                |  |   |
| color                        | 262,144colors                               |                |              |                |                |  |   |
| Contrast                     | 450 : 1                                     |                |              |                |                |  |   |
| Backlight life               | 50,000 hours                                |                |              |                |                |  |   |
| touchpad                     | 4-wire high precision touchpad              |                |              |                |                |  |   |
| RAM                          | 128M  |                |              |                |                |  |   |
| Power supply                 | DC24V(±15%)                                 |                |              |                |                | (DC12~24V)±15%                                 |   |
| Power consumption            | 7 W   |                |              |                |                |  |   |
| CE certification             | Complies with EN50022 and EN50024 standards |                |              |                |                |  |   |
| FCC Compatibility            | omplies with FCC, Class A                   |                |              |                |                |  |   |
| Pressure test                | 1000V AC,1minute                            |                |              |                |                |  |   |
| Protection class             | IP65 ( front panel )                        |                |              |                |                |  |   |
| Working temperature          | 0~55℃(no freezing)                          |                |              |                |                | -20~55℃ ( no freezing )                        |   |
| Working environment humidity | 5~95%RH ( non-condensing )                  |                |              |                |                |  |   |
| shell plastic                | Engineering plasticABS+PC                   |                |              |                |                |  |   |
| Dimensions                   | 275×211×44<br>(mm)                          | 274×180×40(mm) |              | 273×211×39(mm) | 273×211×44(mm) |  |   |
| Hole Size                    | 259×201(mm)                                 | 255×167(mm)    |              | 259×201(mm)    |                |  |   |
| weight                       | About 2.2 kg                                |                | About 1.0 kg |                |                |  |   |

### 3.4.7 SK-104

|                              |   |      |
|------------------------------|---|------|
| network port                 | 1   | none |
| USB programming interface    | 1   |      |
| USB device port              | 1   |      |
| COM port                     | COM1/COM2: RS232, RS422, RS485              |      |
| Display specifications       | 10.4" (L:W = 4:3)                           |      |
| Resolution                   | 800×600                                     |      |
| brightness                   | 450cd/m <sup>2</sup>                        |      |
| color                        | 262,144 colors                              |      |
| Contrast                     | 450 : 1                                     |      |
| Backlight life               | 50,000 hours                                |      |
| touchpad                     | 4-wire high precision touchpad              |      |
| RAM                          | 128M  |      |
| Power supply                 | DC24V (±15%)                                |      |
| Power consumption            | 8W  |      |
| CE certification             | Complies with EN50022 and EN50024 standards |      |
| FCC Compatibility            | Complies with FCC, Class A                  |      |
| Pressure test                | 1000VAC, 1 minute                           |      |
| Protection class             | IP65 (front panel)                          |      |
| Working temperature          | 0~55°C (no freezing)                        |      |
| Working environment humidity | 5~95%RH (non-condensing)                    |      |
| shell plastic                | Engineering plastic ABS+PC                  |      |
| Dimensions                   | 312×225×55mm                                |      |
| Hole Size                    | 285×212mm                                   |      |
| weight                       | about 2.2 kg                                |      |

### 3.4.8 SK-121

|                           |                             |      |   |      |
|---------------------------|-----------------------------|------|---|------|
| network port              | 1                           | none | 1 | none |
| USB programming interface | 1                           |      |   |      |
| USB device port           | 1                           |      |   |      |
| COM port                  | COM1/COM2:RS232,RS422,RS485 |      |   |      |
| Display specifications    | 12.1" (L:W = 4:3)           |      |   |      |

|                              |   |          |
|------------------------------|---|----------|
| Resolution                   | 800×600                                     | 1024×768 |
| brightness                   | 450cd/m <sup>2</sup>                        |          |
| color                        | 262,144 colors                              |          |
| Contrast                     | 450 : 1                                     |          |
| Backlight life               | 50,000 hours                                |          |
| touchpad                     | 4-wire high precision touchpad              |          |
| RAM                          | 128M  |          |
| Power supply                 | DC24V(±15%)                                 |          |
| Power consumption            | 8 W.  |          |
| CE certification             | Complies with EN50022 and EN50024 standards |          |
| FCC Compatibility            | Complies with FCC, Class A                  |          |
| Pressure test                | 1000V AC, 1 minute                          |          |
| Protection class             | IP65 (front panel)                          |          |
| Working temperature          | -20~65°C (no freezing)                      |          |
| Working environment humidity | 5~95%RH (non-condensing)                    |          |
| shell plastic                | Engineering plastic ABS+PC                  |          |
| Dimensions                   | 340×256×54(mm)                              |          |
| Hole Size                    | 330×246(mm)                                 |          |
| weight                       | about 1.8 kg                                |          |

### 3.5 Wiring

Samkoon SK series touch screen requires DC 24V power supply. Figure 1-18 shows the connection of the touch screen with PLC and PC:

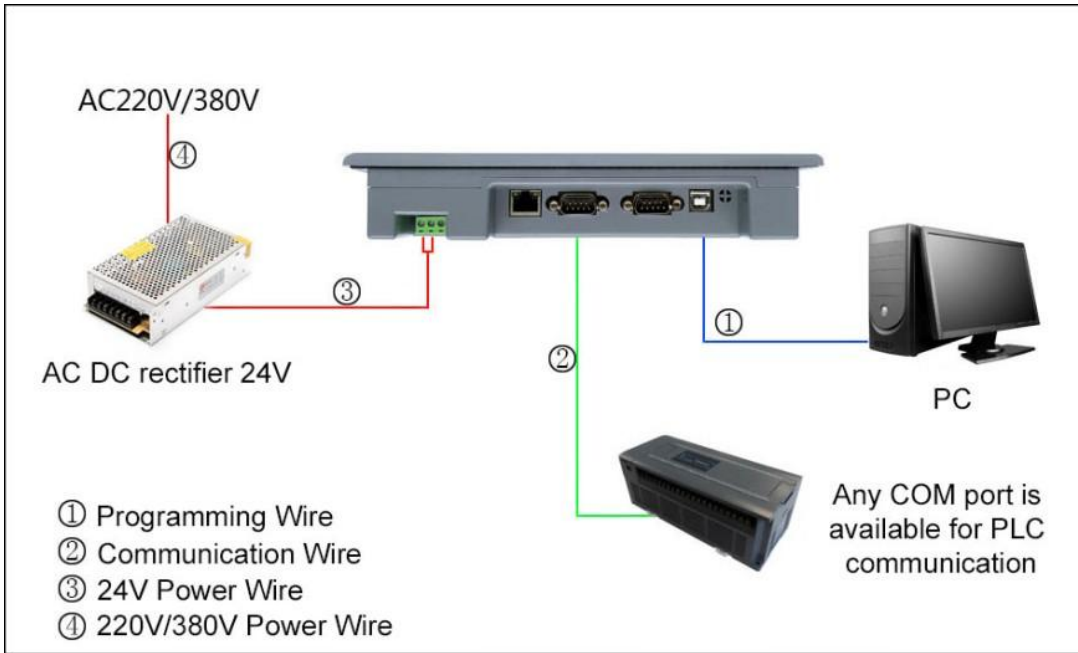

Figure 1-18 Connection diagram of SK series touch screen

USB cables for connection with PC are supplied along with the machine.



---

## 4. Quick start of SKTOOL

---

This chapter introduces installation of SKTOOL configuration software, as well as basic functions and main characteristics of the software. It also introduces in detail the composition of the software system and the functions of each component, helping users to understand the overall structure framework of SKTOOL configuration software. In addition, it introduces the hardware and software requirements of SKTOOL, and the installation process and working environment of SKTOOL, helping users to learn use of this software and create application projects.

Contents:

- [What's SKTOOL](#)
- [System demand](#)
- [Set up SKTOOL Software](#)
- [Run SKTOOL](#)
- [Edit Interface and System Composition](#)
- [Basic Operations](#)

### 4.1 What's SKTOOL



Created for the HMI of Samkoon SK series from Shenzhen Samkoon Technology Co., SKTOOL configuration software is a development system with an integrated development environment and abundant, advanced functions. Taking advantage of the Windows system, it shows its simplicity and good interface consistency. The menu Layout close to that of Windows operating, it is facile to learn and apply, thus engineers can easily develop their proper projects for the configuration used in the SKTOOL. It features a decrease of time to develop automation projects and to upgrade, maintain the system, as well as a seamless integration with third-party applications and productivity enhanced.

Functions and features of SKTOOL are summarized below:

---

## **1. Screen**

Samkoon SK HMI is equipped with 2,6 million display colors, much more bright compared with products of other manufacturers. Using SKTOOL, engineers can find it more convenient and efficient to design configuration projects benefitting from bright colors and rich gallery. When downloaded to HMI, the configuration displays exactly what PC screen shows without image distortion. Meanwhile the operation interface of SKTOOL is clear and concise, consistent with the design of layout menu of Windows. Taking advantages of major display configuration software and HMI configuration software, it is available to configure a high-performance and high-quality engineering document.

## **2. Complete functions**

SKTOOL provides complete functions, including basic drawing shapes, color rendering, text rendering, library system, animation, bitmaps status, trend display, alarm control, etc.. SKTOOL is even equipped with new multiple sets of formulas and historical data, controls effects of pressing and so on. All what is needed for engineers to achieve an expected success is designing programs and configurations according to their own demand project features.

## **3. Communication**

SKTOOL supports PLC communication drivers of major manufacturers in the world, such as Samkoon, Siemens, Mitsubishi, Omron, Fujitsu, Panasonic, Schneider, Emerson, etc., covering the very most of them. At the same time we can customize certain PLC communication drivers. SK-121F, SK-102H, SK-070F, SK-070H from SK series can simultaneously load two communication drivers.

## **4. Resource**

SKTOOL provides abundant resources where Gallery contains three-dimensional indicator lights, three-dimensional buttons, motors, three-dimensional tank, three-dimensional pipes, electronic, bar graphs, etc., and lots of them come with graphic animation, so you can create a vive animation. It supports a custom gallery and pictures inserted from Windows. SKTOOL also provides rich functions of controls, such as trends and alarm controls, etc., to meet the needs of various configurations.

---

## 4.2 System demand

### SKTOOL System demand



---

#### Content:

- [Hardware demand](#)
- [Software demand](#)

#### 4.2.1 Software demand

---

SKTOOL configuration software can run on the following operating systems:

- Microsoft Windows NT Server 4.0 or later;
- Microsoft Windows NT Workstation 4.0 or later;
- Microsoft Windows 98, Me, 2000, XP, win7 or later.



SKTOOL will refuse to install if it does not match the above versions of operating systems.

#### **Recommended systems:**

Windows XP SP3 version; windows7 32; windows7

There is no difference between Chinese and English operating system.

#### 4.2.2 Hardware demand

---

Minimum hardware requirements for SKTOOL are:

CPU: Minimum Pentium 3-800MHz;

Memory: The memory should be 128MB or above if it is Windows 9X operating system;

System memory 256MB or above if Windows NT operating system;

System memory 256MB or above if Windows 2000 or XP operating system;

Graphics: Windows-compatible system, containing more than 1MB of video memory, compatible with 1024 \* 768 resolution, 256-color mode;

Hard: A minimum of 200MB of hard-disk space occupied by SKTOOL configuration software.

Computer with a USB interface;

Mouse with two buttons and keyboard.



SKTOOL can possibly fail to install or run if the configuration of computer is inferior to the above.

**Recommended configuration:**

CPU: Equivalent to Intel's Pentium 800 or above;

Memory: The memory should be 256MB or above if it is Windows 9X operating system;

System memory 512MB or above if Windows NT operating system;

System memory 512MB or above if Windows 2000 or XP operating system.

Graphics card: Windows-compatible system, containing more than 1MB of video memory, compatible with 1024 \* 768 resolution and 65535 color mode.

Hard disk: 200MB or more hard disk space.

### 4.3 Set up Software



SKTOOL is an application software designed for Microsoft Windows 32-bit system. Before installing the software, please make sure that the computer software and hardware meet the minimum requirements for installation.

Execute the installation disk distributed with the product to install SKTOOL. Specific steps are as follows:

Start Windows;

Insert the disc in the appropriate drive;

Contents of the disc are as shown in Figure 2-1, please verify them:



Figure 2-1 Disk content

Please contact us if anything is missing. Thank you for your support and we will serve you sincerely.

After inserting the disk it will automatically pop up SKTOOL setup window (if there is no pop-up window, directly open the disc, execute the file setup\_SK.exe.

After launching the installation, a language selection box pops up as follows. According to user's needs to select English or Simplified Chinese to install the configuration software. Now choose to install this "English" as an example. Select "English", click "OK", and after a few seconds the splash screen will pop up.

In the dialog box, select "Next" to continue the installation or choose "Cancel" to exit the installation program, as shown in Figure 2-3.

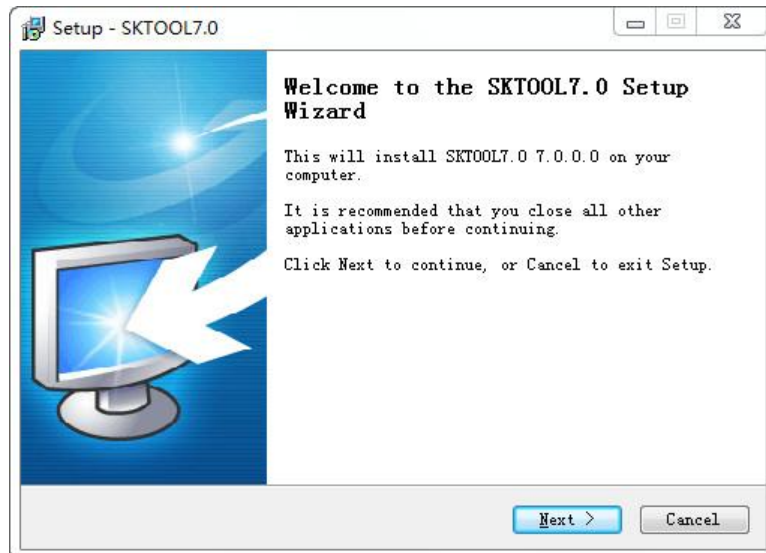

Figure 2-3 Installation Welcome Interface

In the License Agreement dialog box, please choose whether to accept the terms of the software, and then click Next, as shown in Figure 2-4:

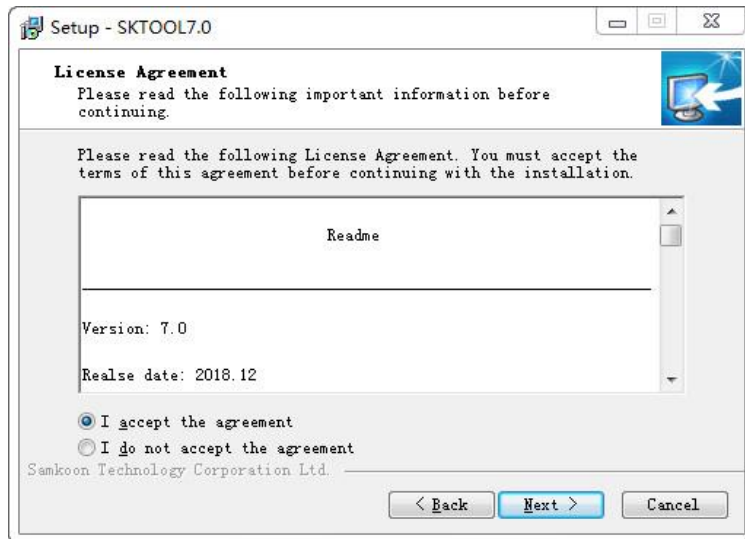
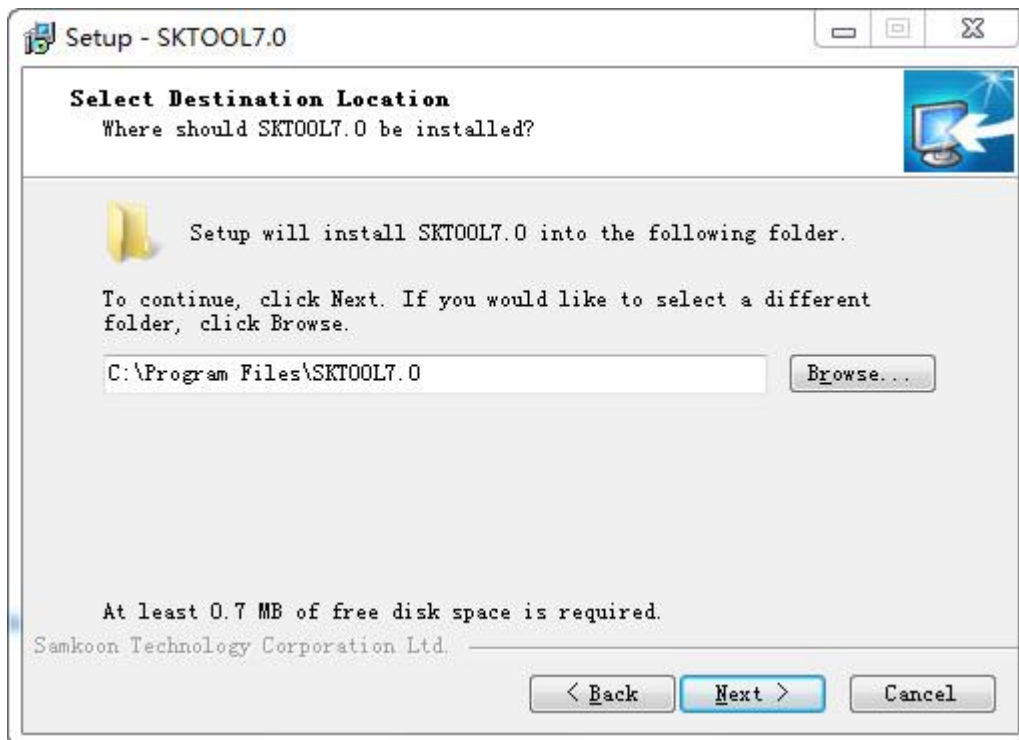

Figure 2-4 License Agreement dialog box

In the Destination Folders dialog box, select the installation folder. The default folder is "C: \ Program File \ SKTOOL6.2\"", click Change can select the installation path, then click Next



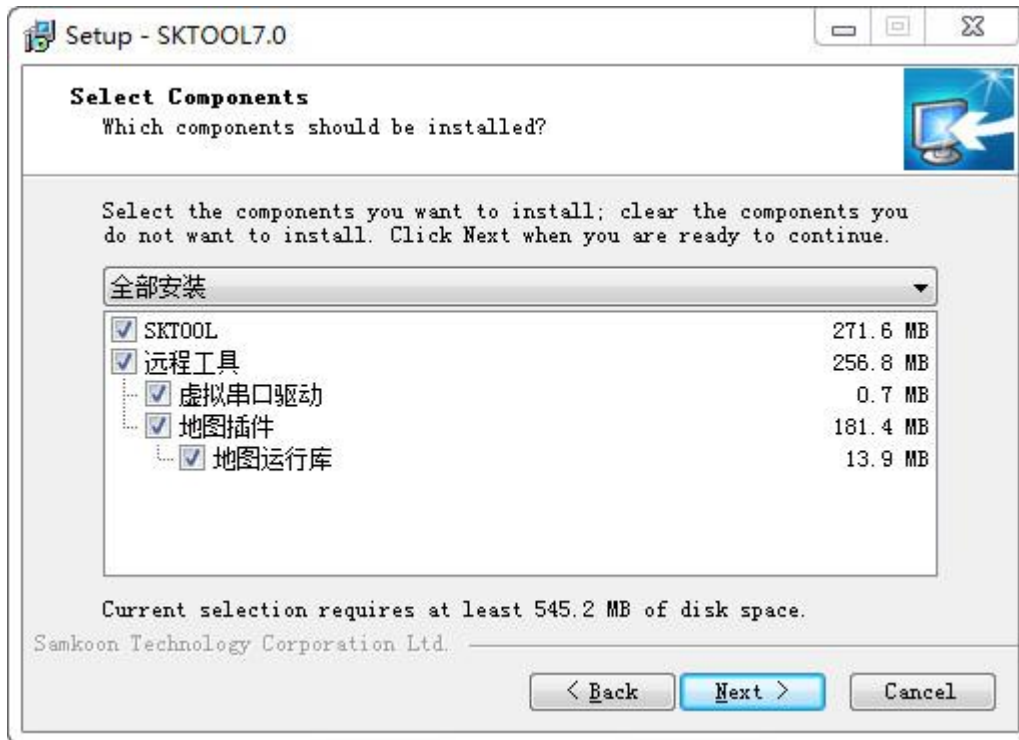

Figure 2-5 Installation Path Interface

Click Next in Figure 2-5, a selection interface shows where to store the file, the default file or others; click Next, as shown in Figure 2-6:

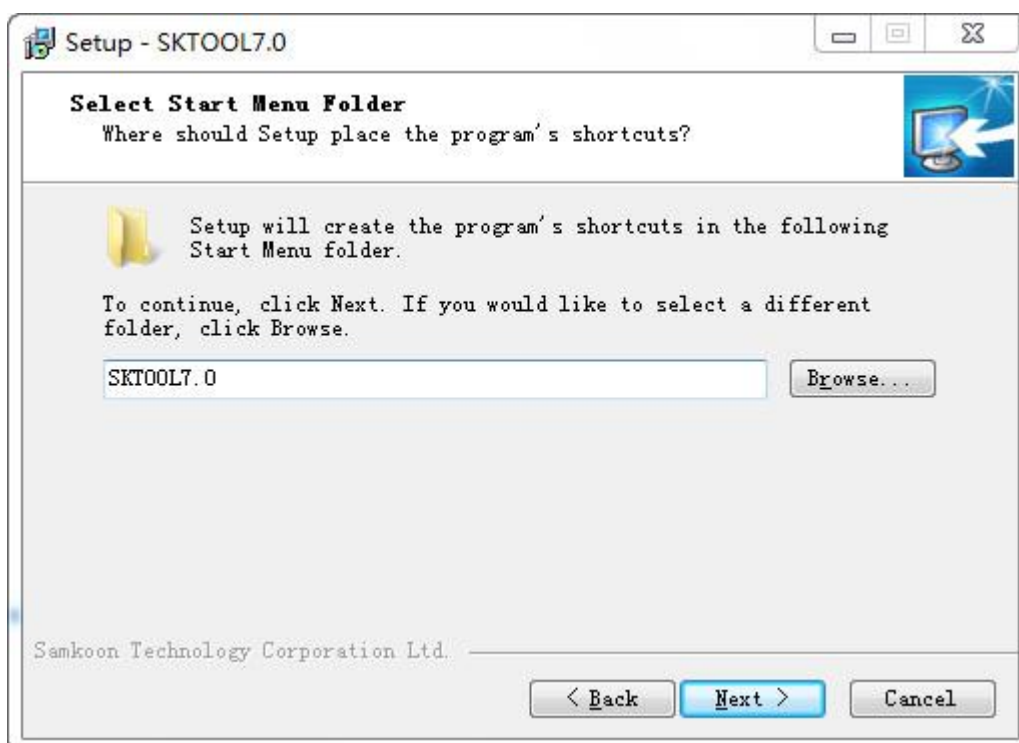

Figure 2-6 Installation File Interface

Whether to Create Desktop Shortcut Interface, click Next, as shown in Figure 2-7:

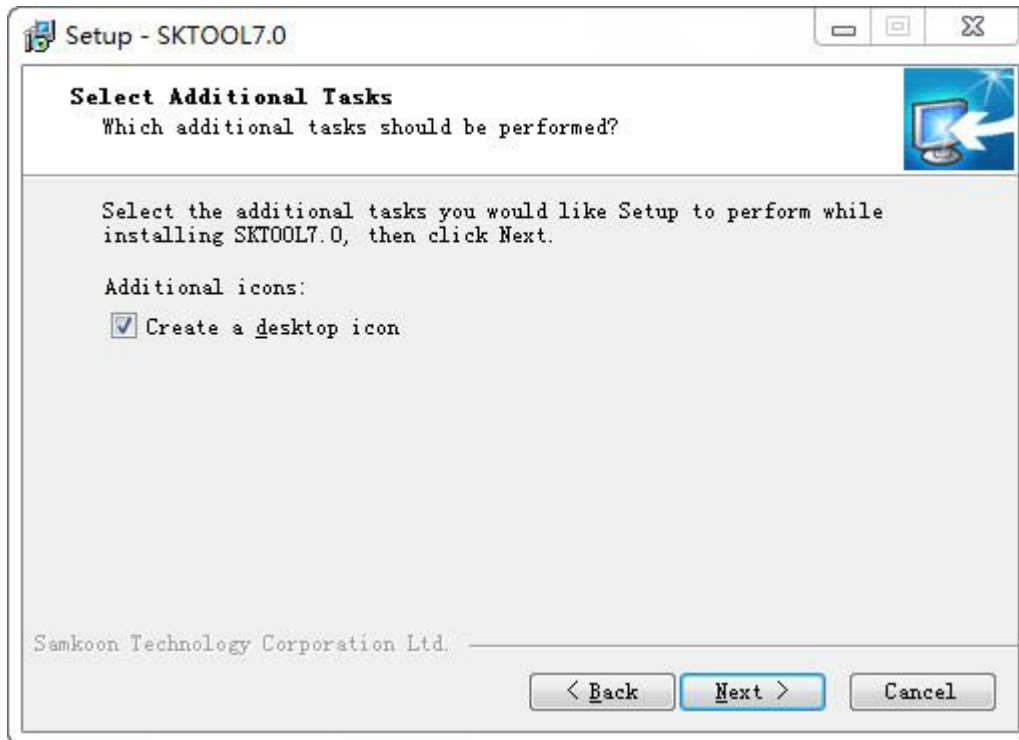

Figure 2-7 Whether to Create Desktop Shortcut Interface

Installation confirmation interface shows three elements: the installation path, files for the installation and whether to create a shortcut.

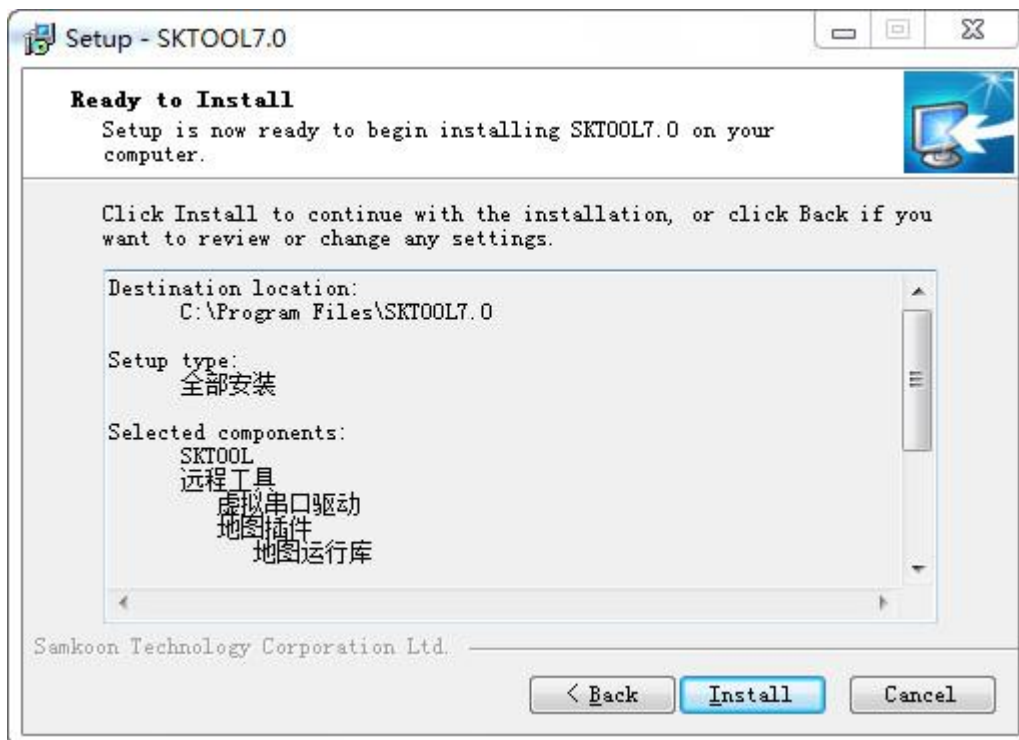

Figure 2-8 Installation Affirmation Interface

Installation Interface, Click Cancel to cancel the installation. As shown in Figure 2-9:



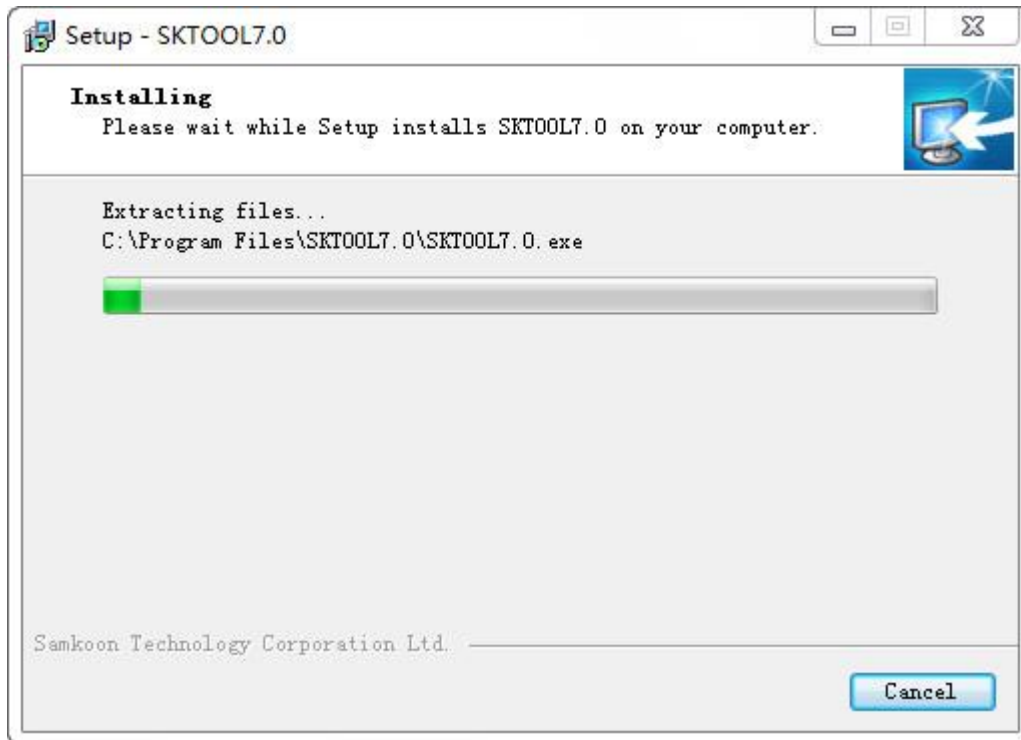
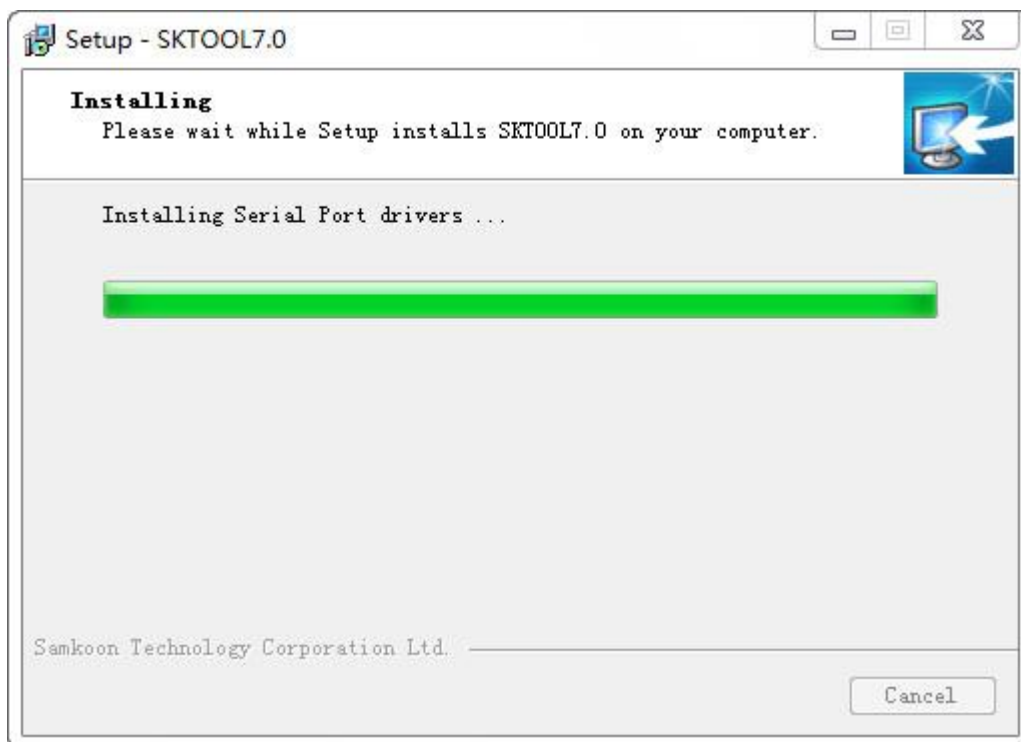

Figure 2-9 Installation Interface

Having installed the software, it will install USB driver automatically. As shown in Figure 2-10:



Having installed the driver, it will display Installation Completed Interface; click Finish to end the installation guide. As shown in Figure 2-11:

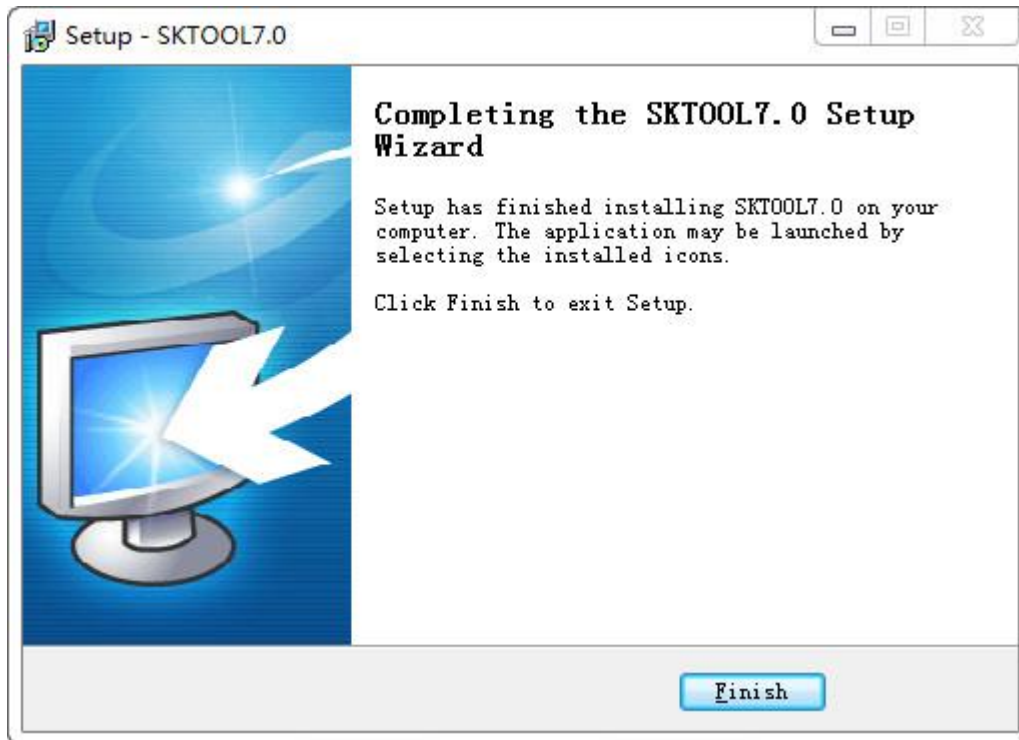

Figure 2-11 Installation Completed Interface

After the installation, the SKTOOL6.2 icon will appear on the desktop. As shown in Figure 2-12:



Figure 2-12 desktop shortcut

If installation CD is unavailable, please download the corresponding download package on Samkoon official website.

## 4.4 Uninstall Software

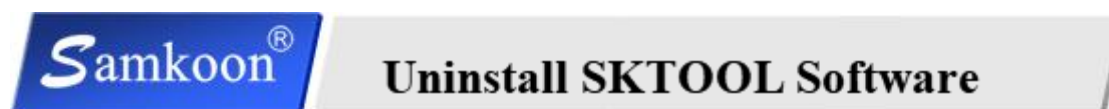

To uninstall SKTOOL configuration software, please follow these steps:

### The first method:

Step one: Select the Windows "Start" - "Programs" - "SKTOOL", choose Uninstall SKTOOL option. As Figure 2-13 shows:

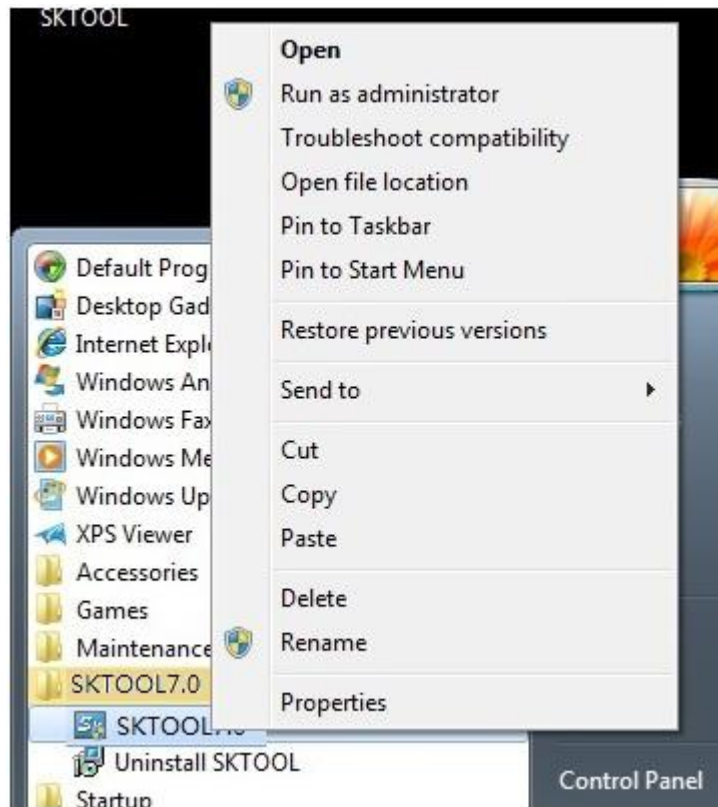

Figure 2-13 choose Uninstall SKTOOL option

Step Two: In the pop-up dialog box, left click "Yes" and wait for Windows system to automatically delete SKTOOL software. When the removal is completed, left click "Finish" button, as shown in Figure 2 -14 and Figure 2-15:

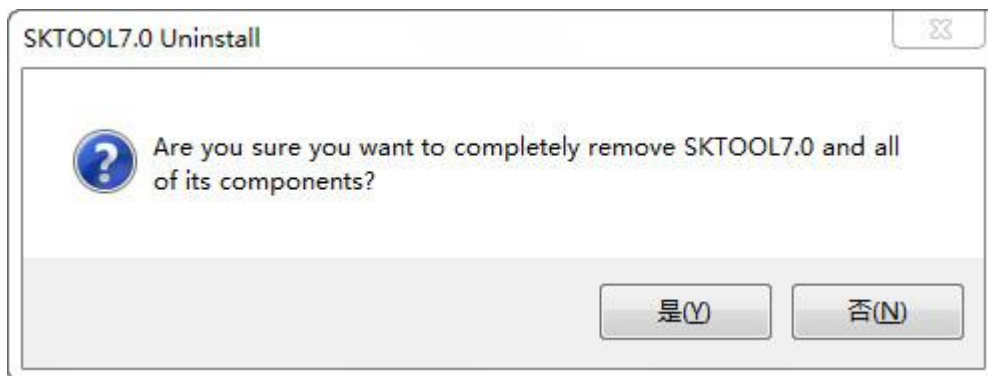

Figure 2-14 Confirm Uninstalling

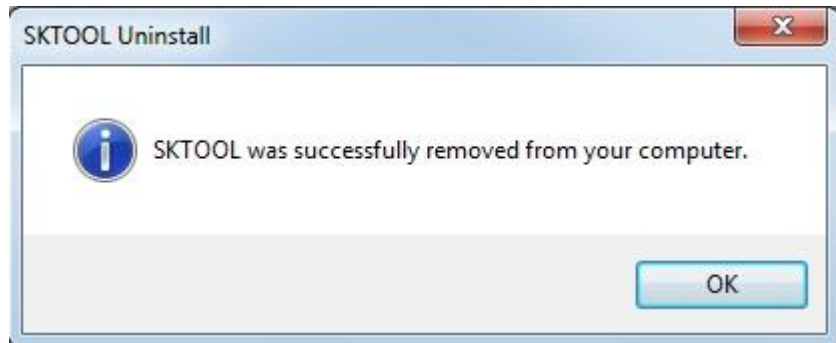

Figure 2-15 Uninstall Completed

**The second method:**

Step One: Select in the Windows "Start" - "Settings" - "Control Panel", go to the Control Panel interface and then select the "Add / Remove Programs" dialog box, as shown in Figure 2-16

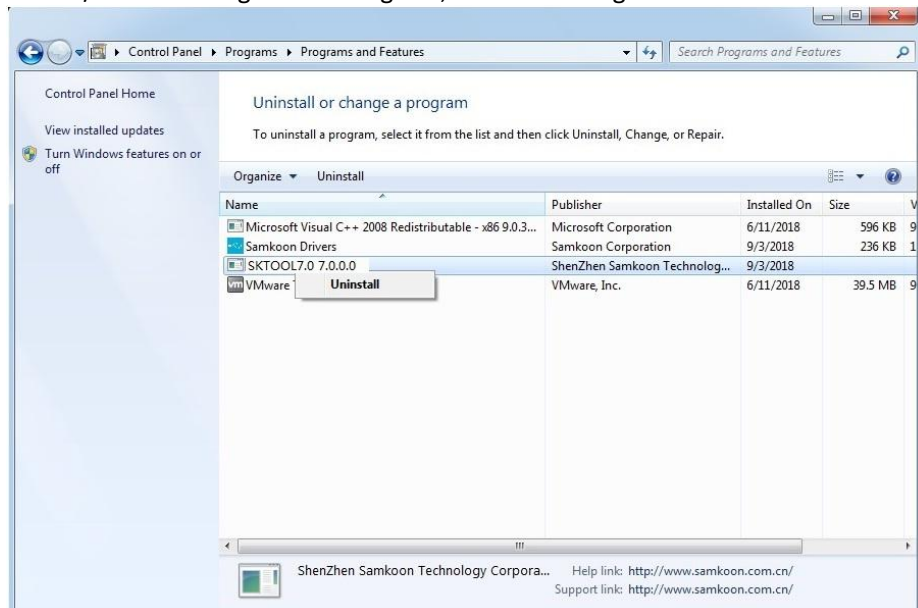

Figure 2-16 Add / Remove Programs

Step Two: Select SKTOOL in the left area of the Figure 2-16, click "Change / Remove" button and follow the second and third step of the first method. Then the system will automatically delete SKTOOL configuration software and its corresponding components.

## 4.5 Run SKTOOL



A shortcut will appear on the desktop after the installation of SKTOOL, as shown in Figure 2-17:



Figure 2-17 desktop shortcut

At the same time, program packages are added to the start menu of Windows, as shown in Figure 2-18

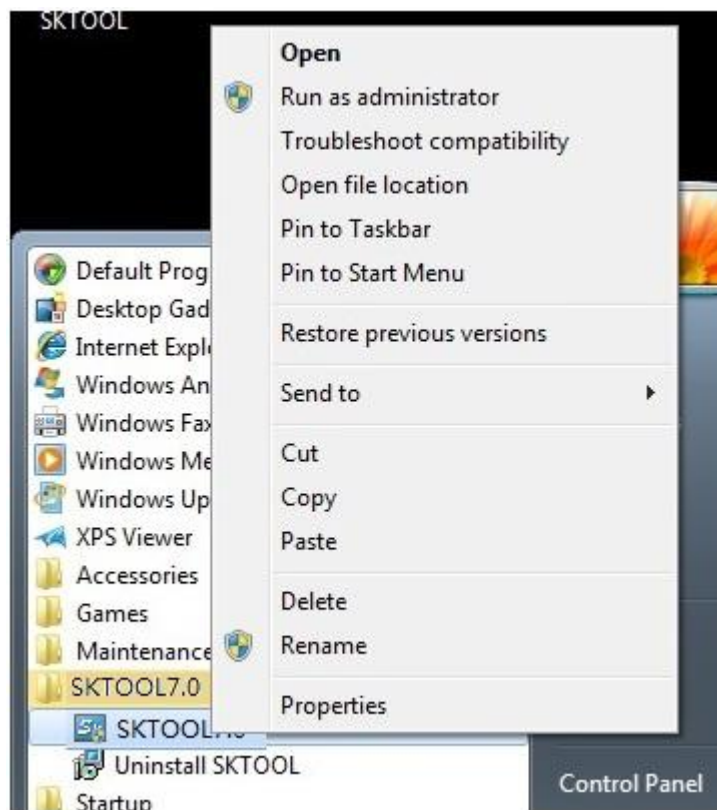

Figure 2-18 start menu program icon

Double click the shortcut on the desktop or the Start menu, click Run SKTOOL.exe SKTOOL configuration software program group, and the interface is shown as Figure 2-19:

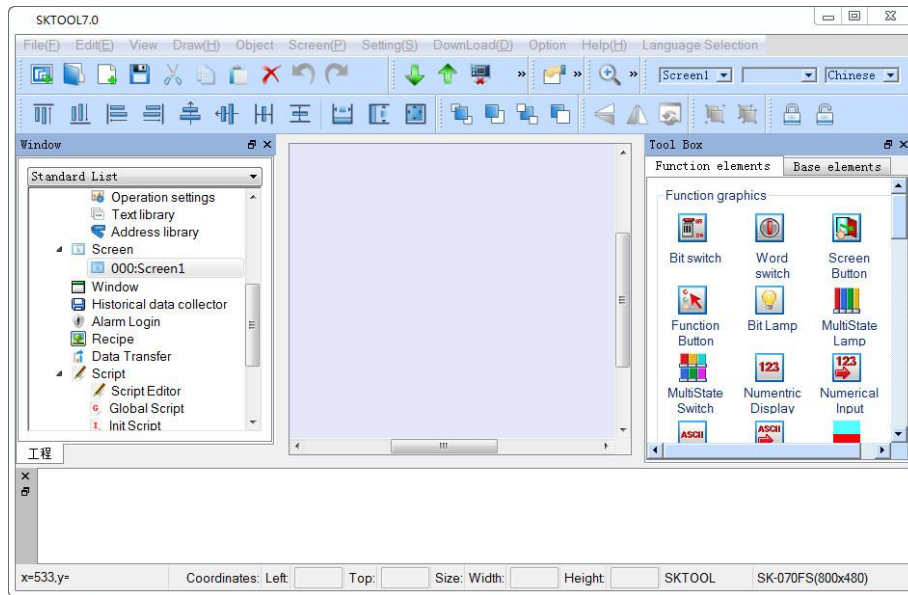

Figure 2-19 Software running interface

## 4.6 Edit Interface and System Composition

### Edit Interface and System Composition



Simple and user-friendly, editing interface of SKTOOL is easy to operate. This chapter introduces configuration screens and each function button of this software.

Contents:

- [Editing interface of SKTOOL](#)
- [System composition of SKTOOL](#)

#### 4.6.1 Edit Interface



Created for the HMI of Samkoon SK series from Shenzhen Samkoon Technology Corporation Ltd. SKTOOL configuration software is a development system with an integrated development environment and abundant, advanced functions. Taking advantage of the Windows system, it shows its simplicity and good interface consistency. The menu Layout close to that of Windows operating, it is facile to learn and apply, thus engineers can easily develop their proper projects for the configuration used in the SKTOOL. Development interface and functional areas are as shown in Figure 2-27:

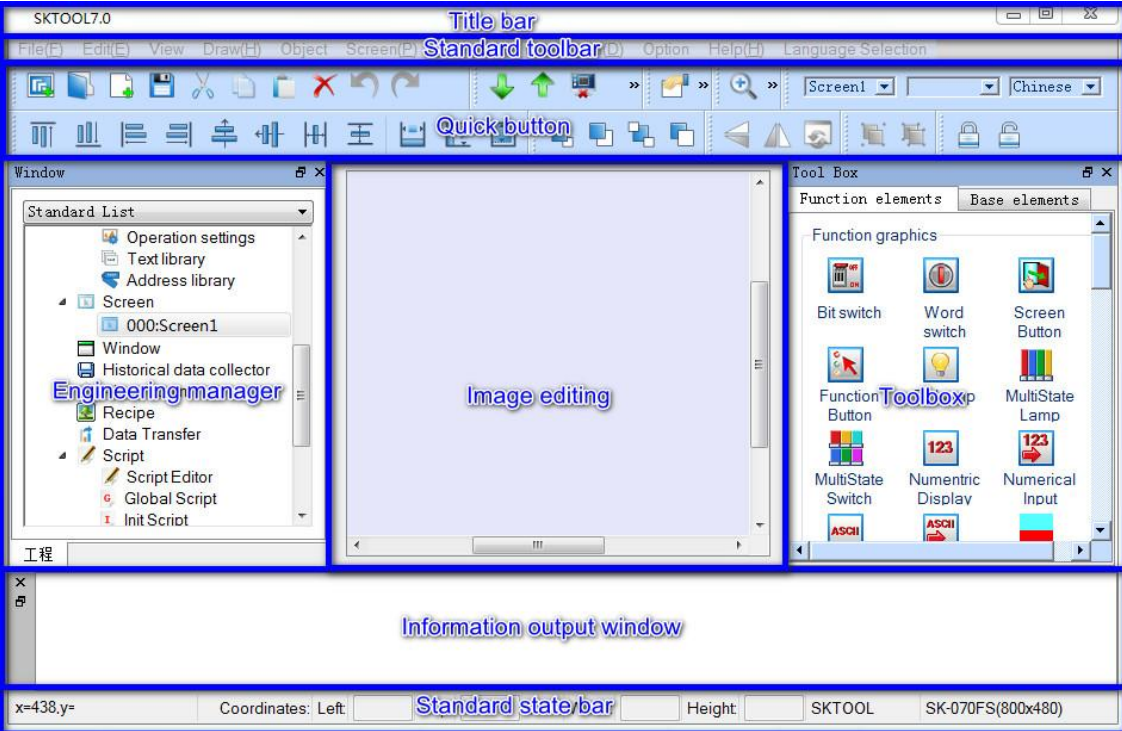

Figure 2-27 Interface and areas of the software

- Title Bar: Display the name of SKTOOL version.
- Menu Bar: Show various command menus of SKTOOL that are all drop-down menu.
- Standard Toolbar: Shortcuts to commands button; Display file; open project; new project; restoration and other function buttons.
- Toolbox: Basic configuration controls designed for engineers to configure; contain function controls and basic controls.
- Picture area window: Window for engineering staff to configure, edit graphic object.
- Project Manager: Communication connections, parameter settings, picture management, alarm settings, set formula and tree-form menu set by historical data collector.
- Information output window: Prompts concerning information input, output, error messages and other tips as engineers conduct configuration editing and compiling.

- Standard Status Bar: The current state of configuration, including the mouse coordinate, the control type, the control coordinate, the control size, etc..

### 4.6.1.1 menu bar



Editing menu bar of SKTOOL configuration software provides users with an extensive menu options, almost covering all the engineering tools and editing commands needed. The menu bar includes File menu, Edit menu, View menu, Draw menu, Object, Screen menu, Setting menu, Download menu, Help menu, Language selection menu, and also a Right-click menu.

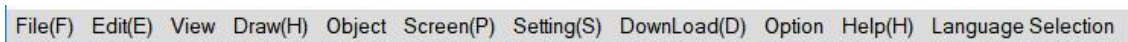

Figure 2-28 Menu bar

#### File menu

"File" menu supports operations of New project (N), Open Project (O), Close, Save (S), Save As and Quit (Q). If a certain item shows gray, it indicates that the operation is invalid in the current environment. The method of opening the file menu is to click "File (F)" on the top left corner of the software, then ejects a pull-down File menu toolbar.



Figure 2-29 "File" menu

- New Project: shortcut key Ctrl + N; to create a blank project.
- Open Project: shortcut key Ctrl + O; to open a project file created, saved before and suffixed by .skm.
- Close: to close the current project file without exiting SKTOOL configuration software.
- Save: shortcut key Ctrl + S; to save the current configuration file having been modified, the name and save path of the file are by default as before.
- Save As: to save the current configuration file; available to override the name and save path of the project.
- Exit: to exit SKTOOL configuration software.

#### Edit menu



"Edit" menu consists of a set of commands used to edit texts, graphics and other content in the screen. There are Undo, Restore, Cut (T), Copy (C), Multiple copy (D), Paste (P), Delete (D), Select All (A), Align, Layer, Group, Mirror, Zoom, Grid, Property setting, Find Address, Address Table, Reverse Select, Macro search, Macro Manager. If a command in the menu bar is gray, it mean in current operation, that command is invalid. To executive these commands, you should first select the graphic object to be edited, and then choose the corresponding command in "Edit" menu. But there are in "Edit" menu some commands that are group commands. If so, a little triangle will show on the right of the command and each command, with a drop-down menu, has a corresponding shortcut.

- Undo: shortcut key Ctrl + Z; to cancel the last operation command and your recent action.
- Restore: shortcut key Ctrl + Y, to restore the last operation command and your recent action.
- Cut: shortcut key Ctrl + X, to delete your selected graphical objects and copy them into the clipboard buffer.
- Copy: shortcut key Ctrl + C; to copy the selected graphic object into the paste buffer.
- Multiple copy: to copy a quantity of selected graphical objects in horizontal and vertical directions, and then the address can be in ascending order of 0-255 units.
- Paste: shortcut key Ctrl + V, to copy and paste buffer graphics objects into the current screen.
- Delete: Del, to remove selected graphical object from the screen.



Figure 2-30 "Edit" menu

- Select: shortcut key Ctrl + A; to select all objects in the current frame of the project.
- Align: to make selected objects (more than two) aligned according to the selected type alignment, including Top, Bottom, Vertical Center, Left, Right, Horizontal Equal Interval, Vertical Equal Interval, Make same width, Make same height, Make same width and height.

- Layer: to place the selected objects to a different picture level. You can choose Bring To Top, Bring Forward, Send to Bottom or Send Backward.
- Group: to combine selected objects (more than two) into one control, or split This command can be selected more than one object (two or more) are combined into a control, an object can also can split a detachable object or split combined objects into the original object. When using Group, please be sure not to assembly objects to touch, otherwise objects can't be touchable after being downloaded to the touch screen. Layer is recommended if it is necessary to overlay touchable objects.



When using Assemble key, do not assemble objects to be touched, or it can't be touched after downloading to the touch screen. Users may use Layer command to superpose touch objects.

- Mirror: to rotate the selected object in accordance with certain rules, horizontally or vertically.
- Zoom: to zoom the current screen in accordance with a certain proportion scale for a more fine control operation; zoom options are Zoom In, Zoom Fit and Zoom Out.
- Grid: to place or cancel a grid with certain width in the current screen.
- Property settings: to open the Properties window of an object (when one single object is selected) and that of a screen (when nothing is currently selected).
- Find Address: to find the address you are using.
- Address Table: to open or close the list of addresses being used. Address Table is a list of address used by objects, easy to find and replace.
- Invert Selection: to select all objects not being chosen in the current screen and objects that are chosen before are not included.
- Macro Search: to locate calls of the macro in the project; you can optionally specify to search or manually enter the search.
- Macro Manager: Execute this command to see locations of all macros used; you can choose to display macros of all the screens or those of a specific screen.

### **View menu**

This menu allows developers to custom their operating interface according to their own habits: decide whether certain operating window is shown in the current operating environment. The icon  $\vee$  on the left of the command means the display of the toolbox on the screen, otherwise it is hidden.

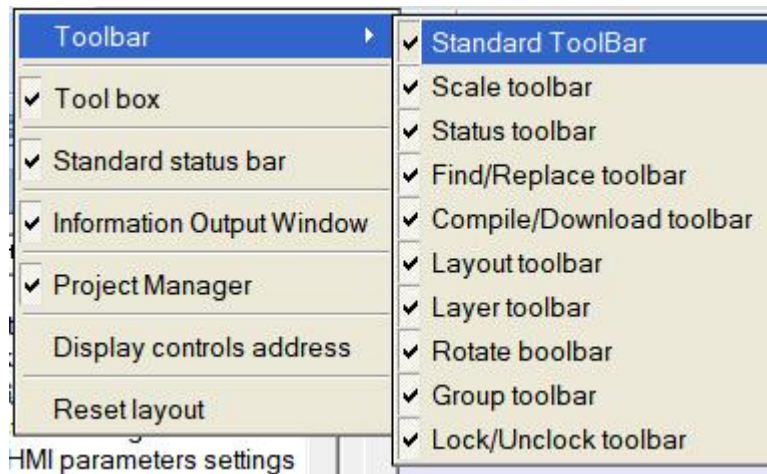

### Draw menu

The menu is mainly used to draw graphics on the screen. SKTOOL provides straight line (L), Polyline (B), Curve / Arc (A), Free Lines, Rectangles (R), Round Rectangle, Ellipse (E), Polygon (Y), Arc, Text (T), Open Library (O), Build Library (C), Table, Scale. It's convenient for engineers to change the color, text, size and location of picture elements created by the Tools menu.



Figure 2-31 "Draw" menu

- Line: Execute this command to draw a straight line in any direction within the current screen.
- Polyline: Execute this command to draw a polyline in any direction within a current picture.
- Curve / Arc: Execute this command to draw a line in the current screen, after finishing drawing by right button, the radian of drawings can be adjusted as needed.
- Free line: Execute this command to draw a line in the current screen in any direction, lines are drawn with the movement of the mouse.

- Rectangle: Execute this command to draw a rectangle of any size in the current screen.
- Rounded Rectangle: Execute this command to draw any rectangle with rounded corners in the current screen.
- Ellipse: Execute this command to draw any size of ellipse in the current screen.
- Polygon: Execute this command to draw an arbitrary polygon in the current screen.
- Arc: Execute this command to draw any sector in the current screen.
- Text: Execute this command to create a transparent rectangle where you can enter any text inside.
- Open Library: Execute this command to open the picture library of the system.
- Build Library: Execute this command to convert the image control drawn by user into a file of library; it is easy to operate next time.
- Table: Execute this command to create a table with required ranks in the current screen.
- Scale: Execute this command to draw a desired scale.

### **Object menu**

"Object" menu consists of a set of touch keys and function keys, including Bit Switch, Word Switch, Screen Button, Function Button, Multifunction key, Stepping Button, Single Button, Combo Box, Sliders, Numerical Display, Numerical Input Display, ASCII Display, ASCII Entry, Bit Lamp, Multistate Switch, Multistate Lamp, Message display, Time Display, Date Display, Weekday Display, Static Picture, Picture Display, GIF Display, Dynamic Diagram, Dynamic circle, Dynamic Rectangle, Flowing block, Graphics Move, Animation, Bar Graph, Meter, Arc chart, Trend Chart, XY Trend Chart, Historic trend, Data group, Historical data, Alarm Control, Alarm Bar, Historical Alarm, Timer, Message Board, Recipe selector, Recipe data display, Keyboard and Qrcode. 'Object' menu corresponds to the third row of the toolbar.

- Bit Switch: Execute this command to create touch keys for performing bit manipulations to the connected device, including Set ON, Set OFF, Dot and Invert.
- Word switch: Execute this command to set a touch key for performing word bit operation in the current screen to the connected device, including Add, Subtract, Increasing, Decreasing, Set Constant, Enter Value, Enter Password.
- More Button: Execute this command to reach the Screen Button, Function Button, Multifunction key, Stepping Button, Single button, Combo Box and Sliders.
- Numerical Display: This command is used to draw on the current screen a numerical display frame reflecting numerical value of certain monitored address.
- Numeric Input Display: Execute this command to draw on the current screen a numerical display frame for data input and digital value display of certain monitored address.
- ASCII Display: Execute this command to draw on the current screen a numerical display frame for ASCII code.
- ASCII Input Display: This command is used to draw on the current screen a frame of display and output for the input of ASCII code.

- Bit Lamp: Execute this command to create on the current screen a picture monitoring the bit status of one single connected device.
- Multistate Switch: Execute this command to create multi-state button monitoring numerical value changes of single address of the connected device according to the change of status.
- Multistate Lamp: You can place a picture in the current screen monitoring the word status of multiple consecutive device addresses.

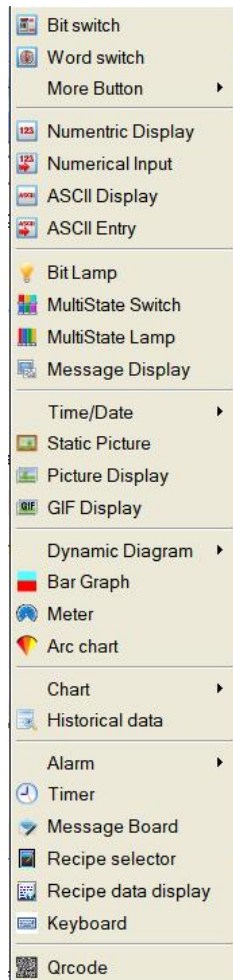

Figure 2-32 "Object" menu

- Message Display: Execute this command to create a display control showing pre-configured message on the current screen.
- Time Display: Execute this command to insert the time control on the screen to show the time.
- Date Display: Execute this command to insert the date control on the screen to display the date.
- Week Display: Execute this command to insert a week control on the current screen to display the week.
- Static Picture: Execute this command to insert a static image of the local hard disk on the current screen.
- Picture Display: This command is used to draw a picture display frame on the current screen for displaying a plurality of pictures.

- GIF Display: Execute this command to draw a picture display frame on the current screen to display a static or animated image suffixed by .GIF.
- Dynamic Diagram: Execute this command to open the windows of Dynamic Circle, Dynamic Rectangle, Flowing block, Graphics Move and Animation.
- Bar Graph: Execute this command to insert a columnar control on the current screen to observe the changes in the numerical value of monitored address according to the rise and fall or the right-left traverse of the columnar picture.
- Meter: Execute this command to create an instrument on the current screen to monitor the changes of numerical value of single address of connected device.
- Arc chart: Execute this command to insert a sector control on the current screen for reflecting the numerical value of monitored address and the reflection area can be presented by Pie FG Color, Pie BG Color or Bottom Color.
- Chart: Execute this command to open the window of Trend Chart, XY Trend Chart, historical trend and Data group.
- Historical Data: Execute this command to create a display control on the current screen to show messages saved by the historical data collector.
- Alarm: Execute this command to open windows of Alarm Control, Alarm Bar and History Alarm.
- Timer: Execute this command to insert a control on the current screen to trigger a particular function according to time conditions.
- Message Board: Execute this command to insert on the current screen a control where users can write.
- Recipe Selector: Execute this command to insert on the current screen a recipe control that shows all names of recipes if they exist.
- Recipe Data Display: Execute this command to insert a recipe data display control on the current screen, which shows all the data of recipes if they are set up.
- Keyboard: Execute this command to insert a keyboard control on the current screen, which can be any key in the keyboard when custom the keyboard.
- Qrcode: Execute this command to insert a Qrcode control on the screen for user-defined Qrcode; It should be used in concert with an input control, otherwise the address is invalid and the Qrcode won't appear.

### Screen menu

"Screen (P)" menu consists of commands applied to screens, including New Screen, Screen Properties (P) and Delete Screen (D)



Figure 2-33 "Screen" menu

- New Screen: Execute this command to create a new screen in the current project.
- Screen Properties: Execute this command to open the properties of the current screen by which you can set the name and background.
- Delete Screen: Execute this command to delete the current screen.



Please make sure the current screen is the one you want to delete and whether there are needed controls before operating cause it cannot be undone.

### Setting Menu

"Setting (s)" menu contains the following commands: Preference Settings (P), File Protection (M), Macro Editor, Global Macro, Initialization Macro and Add Customize Keyboard.



Figure 2-34 "Setting" menu

- Preference Setting: Execute this command to open the preference setting window, in which you can modify the HMI model, display mode, splash screen, screen saver time, flicker frequency, alarm sound, touch sound, password and settings of initial lever.
- File Protection: Execute this command to open the password setting window of file protection through which you can set a password to protect the file of the current project is set in the password window.
- Macro Editor: Execute this command to open the macro editor where you can add, modify, compile or delete a macro.
- Global Macro: Execute this command to open a global macro setting screen, set or modify the global macros.
- Initialization Macro: Execute this command to open the interface of initialization macros setting to set or modify initialization macros.
- Add Customize keyboard: Execute this command to open a user-defined keyboard.



Please keep in mind the password since password is necessary to open the project configuration file after the setting. And it is case-sensitive.

### Download menu

Applied to compile and download the configuration project, “Download” menu contains eight commands, which are Compile (C), Off-line Simulation (M), Online simulation, USB download (D), Upload, Pack/Unpack, Extract project & save as and Extract Remote Simulation Engineering (A). Having connected PC to a touch screen through USB cable, the configuration project can be downloaded via USB download to the touch screen, but you have to compile it before downloading.

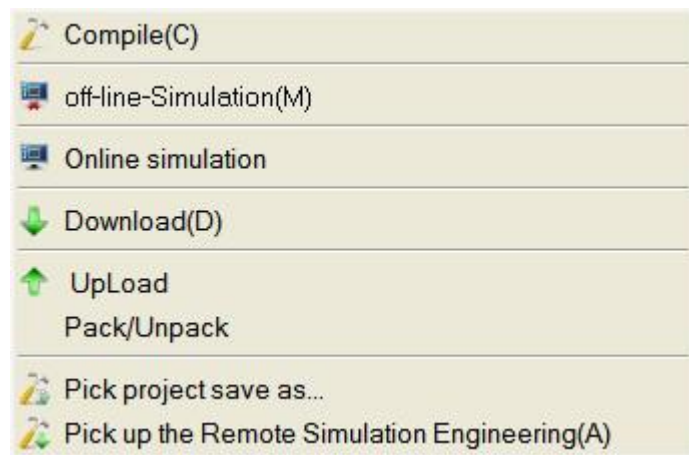

Figure 2-35 “Download” menu

- Compile: Execute this command to examine configuration projects created by users and prepare for download operations.
- Off-line Simulation: Execution of this command can invoke the application program of SKTOOL picture configuration and open the simulation interface. Users can simulate the configuration project running currently on PC to observe the effect, in order to modify the screen. Please save it Off-line simulation before you save the user first.
- Online Simulation: This command can be called SKTOOL screen configuration software application, open the simulation panel, users can simulate engineering currently run on a PC to observe the effect, in order to correct the picture. When online simulation, you can also use the PC's Ethernet or serial communication device connected to data communications and communications test status. Please save it before the online simulation.
- USB Download: Execution of this command can download engineering configuration compiled by SKTOOL software to HMI through a USB cable equipped with the touch screen. Before downloading, please compile and save the project.
- Upload: Execute this command to upload the historical data, configuration, recipes, and historical alarm from the HMI to a PC through a USB cable equipped with the product.



- Pack/ Unpack: Execute this command to compress the project configuration into an XXX.skr file, or to extract the compressed file to the project configuration file .skm.
- Extract Project & Save As: Execute this command to compile the current configuration project to a binary file named u-disk-prj.bin. Saving it in the U disk, instead of USB cable downloading, can update it automatically to the HMI.

Extract Remote Simulation Engineering

**Option menu**

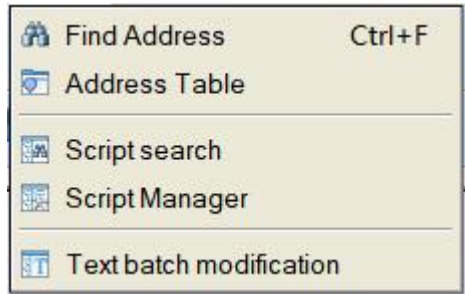

Figure 2-36 "Option" menu

- Find Address: Execute this command to find the address you want and show the using status of the address on Information Output Window.
- Address Table:Execute this command to look for all contols' status on all windows or assigned window.
- Script Table:Execute this command to check the using of the assign macro instruction,and show it on information ouput window.
- Script Manager:Execute this command to look for all macro instructions' status on all windows or assigned window.
- Text batch modification:Execute this command to bitch modify assigned text.

**Help menu**

"Help" menu can call up the Help documentation and About SKTOOL: its version number and copyright notice.

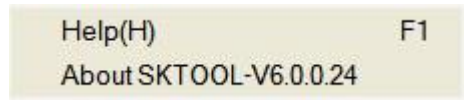

Figure 2-37 "Help" menu

The help file is shown in Figure 2-37:



Figure 2-38 Help file

Version number and copyright statement of SKTOOL are shown in Figure 2-38:

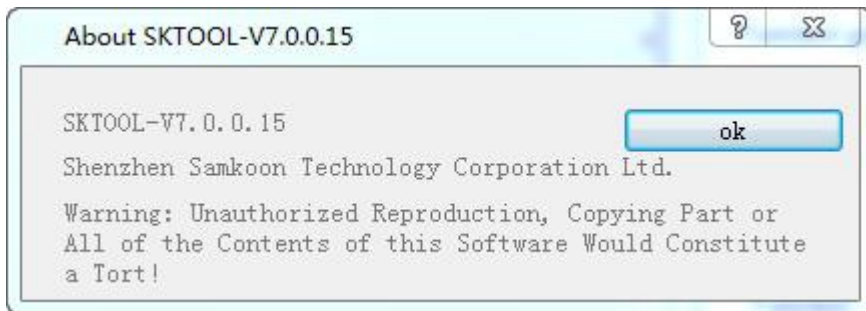
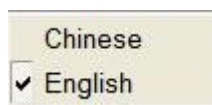

Figure 2-39 Version number statement

### Language Selection menu

The menu can realize Chinese-English switch.

Select "Chinese", and the software is the version of simplified Chinese; or "English", then the English version.



### Right click menu

Right click menu is set to facilitate user's operations, which is consistent with most Windows user's operating

habits and styles. Lots of configuration functions can be found here: Attribute, Objects, Library, Cut, Copy, Multiple copy, Paste, Delete, Select all, Align, Layer, Group, Zoom, Grid, Screen.

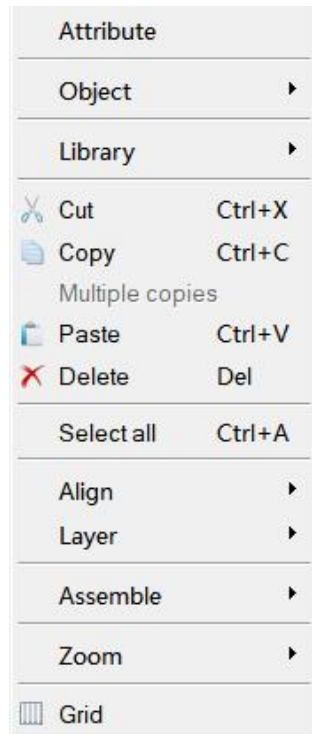

Figure 2-40 “Right click” menu

- Attribute: Execute this command to open the properties window of a control (one single object selected) and the screen (no object selected).
- Object: Execute this command to open all of the object controls in the Object menu.
- Library: Execute this command to open the gallery or generate pictures.
- Cut: Shortcut Ctrl + X; this command can delete your selected graphical objects, and copy them into the clipboard buffer.
- Copy: Shortcut Ctrl + C; execute this command to copy the graphic object of your choice into the paste buffer.
- Multiple copy: Execute this command to copy a quantity of selected graphical objects in horizontal and vertical directions, and then the address can be in ascending order of 0-255 units.
- Paste: shortcut key Ctrl + V, to copy and paste buffer graphics objects into the current screen.
- Delete: Del, execute this command to remove selected graphical object from the screen.
- Select: shortcut key Ctrl + A; execute this command to select all objects in the current frame of the project.
- Align: Execute this command to make selected objects (more than two) aligned according to the selected type alignment, including Top, Bottom, Vertical Center, Left, Right, Horizontal Equal Interval, Vertical Equal Interval, Make same width, Make same height, Make same width and height.

- Layer: Execute this command to place the selected objects to a different picture level. You can choose Bring To Top, Bring Forward, Send to Bottom or Send Backward.
- Group: to combine selected objects (more than two) into one control, or split This command can be selected more than one object (two or more) are combined into a control, an object can also can split a detachable object or split combined objects into the original object.



When using Group, please be sure not to assembly objects to touch, otherwise objects can't be touchable after being downloaded to the touch screen. Layer is recommended if it is necessary to overlay touchable objects.

- Zoom: Execute this command to zoom the current screen in accordance with a certain proportion scale for a more fine control operation; zoom options are Zoom In, Zoom Fit and Zoom Out.
- Grid: Execute this command to create or cancel a grid with certain width on the current screen.
- Screen: Used to create a new screen, open screen property window and delete a screen.



Please make sure the current screen is the one you want to delete and whether there are needed controls before operating cause it cannot be undone.

### 4.6.1.2 Standard Toolbar



SKTOOL offers a series of shortcut tool buttons, some of which are tool command buttons while some belong to editing commands. You can easily get to the needed commands here instead of seeking it in the menu bar if familiar with these buttons. Each button has tooltips that will appear when the mouse is placed on the button. SKTOOL provides a total of 35 tool buttons, which will turn gray if the If the operation is invalid in the current environment.



Figure 2-40 Standard Toolbar

Each command in the toolbar correspond to that in the menu, and their functions are respectively:



New Project: shortcut key Ctrl + N; to create a blank project.



Open Project: shortcut key Ctrl + O; execute this command to open a project file created, saved before and suffixed by .skm.



New Screen: Execute this command to create a new screen in the current project.



Save: shortcut key Ctrl + S, used to save the current screen configuration that has been changed, with the file name and directory being the same as the original.



Undo: shortcut key Ctrl + Z; to cancel the last operation command and your recent action.



Redo: shortcut key Ctrl + Y, to restore the last operation command and your recent action.



Cut: shortcut key Ctrl + X, to delete your selected graphical objects and copy them into the clipboard buffer.



Copy: shortcut key Ctrl + C; to copy the selected graphic object into the paste buffer.



Paste: shortcut key Ctrl + V, to copy and paste buffer graphics objects into the current screen.



Delete: Del, to remove selected graphical object from the screen.



Group: Execute this command to combine several graphic objects you select into one object.



Ungroup: This command can decompose a combination of graphic objects you have selected into the original graphic objects; it's the inverse operation of Group.



Flip Horizontal: Execute this command to make a single graphic or multiple graphics pivot horizontally.



Flip Vertical: Execute this command to make a single graphic or multiple graphics pivot vertically.



Grid: Execute this command to create or cancel a grid with certain width on the current screen.



Zoom in: Execute this command to magnify the current screen two times; to continue to enlarge, please continue to execute the command.



Zoom fit: Execute this command to restore the current screen to the standard size.



Zoom out: Execute this command to shrink the current screen half the size; to continue zooming out, proceed to execute the command.

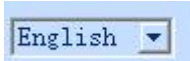

Language: Execute this command to select the language you want.



Status drop-down box: If select a control with status, the drop-down box will show the number of control status; if the number in the box changes, the status of the selected control will switch into corresponding status.

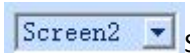

Screen frames: Execute this command to jump to the page you want to view.



Property settings: Execute this command to get the properties of the selected key.



Locked: Execute the command to lock the key selected on the screen and it can not be moved after locking.



Unlock: Execute this command to remove the locking of screen buttons.



Find/replace the button:click the button, and the user can find all the usage of the specific register and can be replaced by the other.



Address Find: Execute this command to find out whether an address is occupied and the search results are displayed in the "information output window".



Address display: Execute this command to browse the used address of all controls in certain screens or all the screens.



Find macro: Execute this command to find whether a macro is used; the search result is displayed in the "information output window".



Macro Manager: Execute this command to see the macro condition of all controls in certain screens or all the screens.



Click the button to modify the selected control, screen, and text in the window.



Rotate the command, select the control, and use it to rotate freely in the center of the control.



Use this command to open the tool buttons that are not displayed; when the mouse moves away, the popup disappear.



Off-line simulation: Execute this command to run directly off-line simulation command.



Online simulation: Execute this command to run directly online simulation command.



Compile: Execute this command to check user's own configuration engineering and get ready to download.



Download: Execute this command to pop up the download dialog; after connecting the SK HMI to PC, you can download the configuration project to the touch screen.



Upload: Execute this command to upload historical data, configuration, formulas and alarm history from a running HMI to a PC via the equipped USB cable.



Layer: Level drop-down box, includes four operating controls: Bring to top, Send to bottom, Bring forward and Send backward

- Bring To Top (F): Execute this command to shift the graphic object you selected to the top of the screen.
- Send To Bottom: Execute this command to shift the graphic object you selected to the bottom of the screen.
- Bring Forward: Execute this command to shift the graphic object you selected forward one layer.
- Send Backward (B): Execute this command to shift the graphic object you selected backward one layer.



Size: Size drop-down box includes three operating controls: same width and height, same height, same width.

- Make same width: Use this command to make a group of selected patterning the same width as that marked by a black point.
- Make same height: Use this command to make a group of selected patterning the same height as that marked by a black point.

- Make same width and height: Use this command to make a group of selected patterning the same width and height as that marked by a black point.



Alignment: Alignment drop-down box includes a total of eight operating controls: left-aligned, right-aligned, Vertical Center, Horizontal Center, Top, Bottom, Horizontal Equal Interval and Vertical Equal Interval.

- Left: Shortcut key Ctrl + Left, execute this command to left justify the left edges of selected graphic objects.
- Right: Shortcut key Ctrl + Right, execute this command to right justify the right edges of selected graphic objects.
- Top: Shortcut key Ctrl + Up, execute this command to align upper boundaries of selected multiple graphic objects top.
- Bottom: Shortcut key Ctrl + Down, execute this command to align lower boundaries of selected graphic objects bottom.
- Horizontal Center: Execute this command to align selected graphics horizontal center.
- Vertical Center: Execute this command to align selected graphics vertical center.
- Horizontal Equal Interval: Execute this command to make two or more controls align horizontally equal interval.
- Vertical equal interval: Execute this command to make two or more controls align vertically equal interval.

### 4.6.1.3 Project Manager



SKTOOL Project Manager window is in the left of configuration software window, below the toolbar. You can here set the parameters of the touch screen, including Multi-language Settings, Connection, Setting, Screen, Window, Historical data collector, Alarm landing, Formula, Data transmission and Macro; Connection consists of Connection 1 and Connection 2 settings which contains HMI parameter settings, HMI state, PLC control, Clock, File encryption, HMI protection and Variable table.



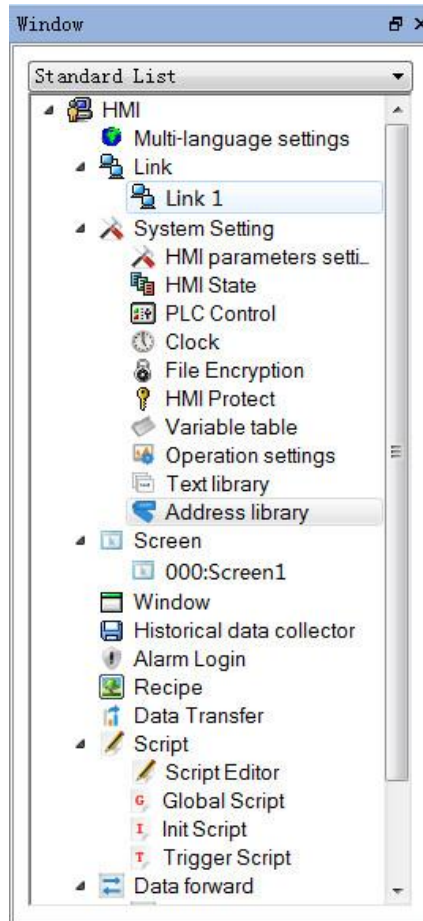

Figure2-41 Project Manager window

#### 4.6.1.4 Toolbox



SKTOOL Toolbox provides a wealth of tool buttons, some of which are functional control buttons, and some are basic controls. After being familiar with these buttons, designers can quickly find the commands they need instead of searching in the menu bar. SKTOOL supports totally 47 function controls and 14 basic controls.

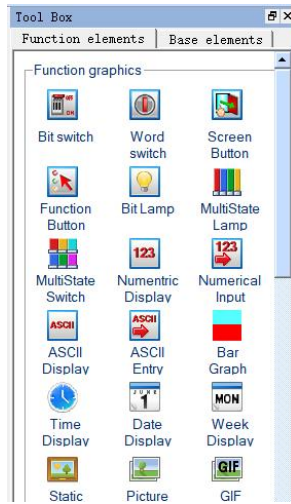

Figure 2-42 Toolbox functional control buttons

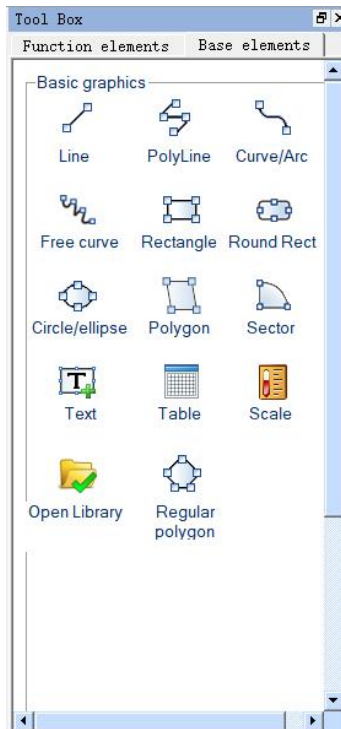

Figure 2-43 Toolbox basic control buttons

Toolbox individual operating controls and menu content corresponding to each other, each button functions are:



Line: Execute this command to draw a straight line in any direction within the current screen.



Polyline: Execute this command to draw a polyline in any direction within a current picture.



Curve / Arc: Execute this command to draw a line in the current screen, after finishing drawing by right button, the radian of drawings can be adjusted as needed.



Free line: Execute this command to draw a line in the current screen in any direction, lines are drawn with the movement of the mouse.



Circle/Ellipse: Execute this command to draw any size of circle or ellipse in the current screen.



Rectangle: Execute this command to draw a rectangle of any size in the current screen.



Rounded Rectangle: Execute this command to draw any rectangle with rounded corners in the current screen.



Polygon: Execute this command to draw an arbitrary polygon in the current screen.



Arc: Execute this command to draw any sector in the current screen.



Text: Execute this command to create a text input on the screen.



Table: Execute this command to create a table with required ranks in the current screen.



Scale: Execute this command to draw a desired scale.



Open Library: Execute this command to open the picture library of the system.



Bit Switch: Execute this command to create touch keys for performing bit manipulations to the connected device, including Set ON, Set OFF, Dot and Invert.



Word switch: Execute this command to set a touch key for performing word bit operation in the current screen to the connected device, including Add, Subtract, Increasing, Decreasing, Set Constant, Enter Value, Enter Password.



Screen Button: Execute this command to set the switching of screens, including opening screen, open the previous screen, close and Open screen, Closes screen, Open previous screen and Close open screen.



Function Button: Execute this command to set a certain function control of the operating system, including Turn off background light, Confirm alarms, Restart HMI, Set screen saver time, Write recipe to PLC, Read recipe from PLC, Set the date and time, Clear alarm, Switch to previous recipe, Switch to later recipe,

Save current recipe, Screenshots, System parameters, User login, Cancel the user login, Touch sound ON / OFF, Alarm sound ON / OFF, Clear all historical data, Clear alarm history, Unlock HMI protection, read& save recipe, Spare function, Overload recipe, Switch language, Print screen to printer, Slave devices IP config, DIP switches 1 and 3 feature set.



Stepping button: Execute this command to create a stepping button control in the current screen to realize the cyclic switching of execution states.



Single button: Execute this command to create a single button control in the current screen; click the designated state area, then the state will switch accordingly.



Combo box: Execute this command to create a drop-down box button control in the current screen, for viewing and selection. Once user selects an item, the corresponding value will be written into the control address of character buffer.



Slider: Execute this command to create a slider analog switch control in the current screen; drag the slider to change the value of corresponding character register addresses.



Numerical Display: This command is used to draw on the current screen a numerical display frame reflecting numerical value of certain monitored address.



Numeric Input Display: Execute this command to draw on the current screen a numerical display frame for data input and digital value display of certain monitored address.



ASCII Display: Execute this command to draw on the current screen a numerical display frame for ASCII code.



ASCII Input Display: This command is used to draw on the current screen a frame of display and output for the input of ASCII code.



Bit Lamp: Execute this command to create on the current screen a picture monitoring the bit status of one single connected device.



Multistate Switch: Execute this command to create multi-state button monitoring numerical value changes of single address of the connected device according to the change of status.



Multistate Lamp: Place a picture in the current screen to monitor the word status of multiple consecutive device addresses.



Message Display: Execute this command to display corresponding message information according to different monitoring address.



**Recipe Selector:** Execute this command to insert on the current screen a recipe control that shows all names of recipes and enter, monitor contents of RWIO.



**Recipe Data Display:** Execute this command to insert a recipe data display control on the current screen, which shows all the data of recipes if they are set up.



**Multi-function button:** Execute this command to create a multi-function button in the current screen to realize multiple functions through one key.



**Keyboard:** Execute this command to insert a keyboard control on the current screen, which can be any key in the keyboard when custom the keyboard.



**Time Display:** Execute this command to insert the time control on the screen to show the time.



**Date Display:** Execute this command to insert the date control on the screen to display the date.



**Week Display:** Execute this command to insert a week control on the current screen to display the week.



**Static Picture:** Execute this command to insert a static image of the local hard disk on the current screen.



**Picture Display:** This command is used to draw a picture display frame on the current screen for displaying a plurality of pictures.



**GIF Display:** Execute this command to draw a picture display frame on the current screen to display a static or animated image suffixed by .GIF.



**Dynamic circle:** Execute this command to create a dynamic circle in the current screen whose size and location transform according to the continuous address change of connection device.



**Dynamic Rectangle:** Execute this command to create a dynamic rectangle in the current screen whose size and location transform according to the continuous address change of connection device.



**Flow block,** use this command to create a simulation control of flow state in the current screen.



**Graph Move:** Execute this command to create a graph display frame in the current screen whose graphic state and location change according to the continuous address change of connection device.



**Animation:** Execute this command to create an animation control in the current screen to move the control.



Meter: Execute this command to create an instrument on the current screen to monitor the changes of numerical value of single address of connected device.



Arc chart: Execute this command to insert a sector control on the current screen for reflecting the numerical value of monitored address.



Pie chart: Execute this command to insert a sector control on the current screen for reflecting the numerical value of monitored address



Bar Graph: Execute this command to insert a columnar control on the current screen to observe the changes in the numerical value of monitored address according to the rise and fall or the right-left traverse of the columnar picture.



Trend Chart: Execute this command to create a trend chart control in the current screen to monitor the change trend of continuous address value of connection device.



XY Trend chart: Execute this command to create a XY trend chart control in the current screen to monitor the change of two continuous address value of connection device.



Data group display: Execute this command to create a data group display control in the current screen to display several groups of data in the trend chart.



Historical Trend Chart: Execute this command to create a historical trend chart control in the current screen to display historical data in the trend chart.



Historical record display: Execute this command to create a historical record display control in the current screen to display historical data collected.



Historical Alarm display: Execute this command to create a display control of historical alarm record in the current screen to show historical alarm data.



Alarm display: Execute this command to create an alert box control in the current screen to display the date, time and message of each alert.



Alarm Bar: Execute this command to create an alert bar in the current screen to scroll display alert information.



Operation log: Execute this command to create an operation log display frame in the current screen to display the time, user and contents of the operation.



Timer: Execute this command to create a macro timer in the current screen to control the execution of the macro.



Message Board: Execute this command to create a message board control in the current screen where users can write.



QRcode: Execute this command to create a QR code control in the current screen to display character or number with the help of input control.



Corner flow block: Execute this command to create a Corner flow block control in the current screen to display the shape and flow speed.



Multi-Window: Execute this command to create a multi-window control in current screen to display the assigned window.



ScrollBar

:Scroll bar control to draw different types of scroll bars for table data browsing



Pipeline

:Pipeline control, and the control of a scroll bar

## 4.6.2 System Composition

SKTOOL is a configuration editing software of Samkoon HMI. SKTOOL allows engineers to edit the configuration on the PC, and then download the final configuration and required communication driver to communication and the required driver to the storage mechanism of the touch screen with a USB cable; HMIs can be controlled and monitored after being connected to PLCs or other connection devices through actuators and serial communication ports. Figure 2-44 shows SKTOOL system composition.

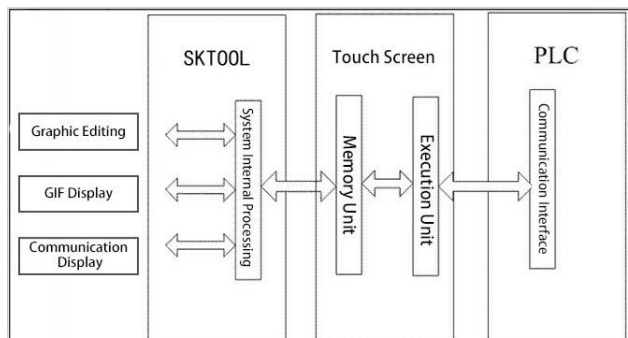

Figure 2-44 SKTOOL System Composition

## 4.7 Basic Operations

---

This chapter describes briefly the mouse usage, shortcut keys and some of the terminology of SKTOOL software.

### Contents:

- [Mouse usage and shortcut keys](#)
- [SKTOOL's common terms](#)

### 4.7.1 Mouse usage and shortcut keys

---

When use the mouse to create configuration screens on the configuration screen editor, the mouse is as shown in Figure 2-45:



Figure 2-45 Sketch of mouse

The following is several common operations of mouse and their purposes:

#### ◎ Left-click

Press the button on the left side, then release—this is referred to in the book [click], used in the selection menu, to select the object, choose Tool buttons, edit configuration picture, confirm settings.

#### ◎ Double left click

Press the button twice in rapid succession on the left side—this is referred to [Double] in this book, applied to attribute setup for existing parts on the screen: screen and window attributes, touch screen connection properties, set properties; to change settings of Historical data collector, formulas, alarms and other control options.

#### ◎ Right-click

Press the key on the right, then release —this is referred to in the book [right-click]. Right-click on a part can open the right drop-down menu, or right-click in the space display the context menu. You can also quit the editing state, restore the mouse state.



## © Drag

Move the mouse while hold the button-- this is called in the book [drag], using the drag operation can select multiple items to move parts, mobile pop-up edit windows.

## Shapes of the mouse

While edit with SKTOOL configuration software, the shape of the mouse will changes with different operations to distinguish different types of operation.

The following table 2-1 shows available operations under various shapes of the mouse when edit screens:









|   |   |
|---|---|
|    | Select objects; click tool buttons            |
| +   | Paste   |
|    | Draw graphs                                   |
| I   | Input text                                    |
|    | Enlarge the objet vertically                  |
|  | Enlarge the objet horizontally                |
|  | Enlarge the objet vertically and horizontally |
|  | Readjust                                      |
|  | Enlarge the objet vertically and horizontally |
|  | Rotate the object                             |

Table 2-1 Shapes of the mouse and their meanings

## Shortcut keys

Table 2-2 below lists common shortcut keys. Designers can use these keys to quicken the configuration.

|                   |                                     |
|-------------------|-------------------------------------|
| CTRL+C            | Copy                                |
| CTRL+V            | Paste                               |
| CTRL+X            | Cut                                 |
| CTRL+F            | Jump picture                        |
| CTRL + drag       | Copy the selected objet and move it |
| CTRL + left click | Select multiple objects             |

|         |  |
|---------|--|
| ← → ↑ ↓ | Move the selected object left and right, up and down |
| ESC     | Undo the operation                                   |
| DEL     | Delete   |

Table 2-2 Shortcut keys

## 4.7.2 Common terms

Table 2-3 below displays some common terms in configuration editing.

|                   |   |
|-------------------|---|
| Project           | Shortened from user's application system. Introducing the concept of project means to make complex computer expertise easier for the general engineers. Files created in SKTOOL configuration is suffixed by .skm; it can be stored in any specified location.  |
| Object            | Operating goals and operating environment, collectively called Object, such as windows, components, data, graphs and objects  |
| Select the object | Making a window or object operable by a mouse click is referred to select object, the selected object (including windows) is also known as the current object   |
| Configuration     | Define, create and edit object in a window environment and set its status feature (attribute) parameter   |
| Attribute         | Name, genre, state, property and the usage are called collectively Attribute  |
| Menu              | A set of execution commands. For example, the system menu "File" menu is used to dealing with execution commands related to project documents. SKTOOL menus are all pull-down menus that can also be divided into multiple levels, each known as a sub-sub-menu |
| Command Button    | Buttons with certain command operations, part of which in the toolbar while part of in the menu bar   |
| Set ON            | Switch the object with bit status display to state "ON"   |
| Set OFF           | Switch the object with bit status display to state "OFF"  |
| Style             | A transition effect of object from the foreground to the background color   |

---

|                   |  |
|-------------------|--|
| Address           | Memory variables related to the current object     |
| Connecting device | Communication devices connected to current project |
| Control           | Set of particular functions                        |

Table 2-3      common terms

---

## 5. Basic steps of creating a new project

---

This chapter introduces basic steps of creating a new project.

### Contents:

- [Create new project](#)
- [Set parameters and add graphic object](#)
- [Download configuration engineering](#)
- [Upload configuration engineering](#)
- [Upload historical data record](#)
- [Pack/Unpack](#)

### 5.1 Create new project



This operation is necessary when engineers need to create a new project. Select New Project in the File menu or New Project button  in the tool bar, then SKTOOL will pop up the "New Project dialog box" where you can decide the name and storage path of the project. Select the corresponding HMI model; click OK to complete creating a new project and enter into the dialog box of Communication port settings; click Cancel to exit the dialog box.

#### 1. New project dialog box

Project name:

Path: Storage path of new project file; the default is C: \

Model: Available models for projects:

SK-035FE(320\*240 )

SK-035UE(320\*240 )

---

SK-043FE(480\*272 )  
SK-043FS(480\*272 )  
SK-043HE(480\*272 )  
SK-043HS(480\*272 )  
SK-043UE(480\*272 )  
SK-050FS(480\*272 )  
SK-050FE(480\*272 )  
SK-050HS(800\*480 )  
SK-050HE(800\*480 )  
SK-057FE(640\*480 )  
SK-070FS(800\*480 )  
SK-070FE(800\*480 )  
SK-070HS(800\*480 )  
SK-070HE(800\*480 )  
SK-070GS(800\*480 )  
SK-070GE(800\*480 )  
SK-070GG(800\*480 )  
SK-070GW(800\*480 )  
SK-070MS(800\*480 )  
SK-070ME(800\*480 )  
SK-070MG(800\*480 )  
SK-070MW(800\*480 )  
SK-102FS(800\*480 )  
SK-102FE(800\*480 )  
SK-102HS(1024\*600)  
SK-102HE(1024\*600 )  
SK-102CS(1024\*600 )  
SK-102CE(1024\*600 )  
SK-102CG(1024\*600 )  
SK-102CW(1024\*600 )  
SK-121FS(800\*600 )  
SK-121FE(800\*600 )  
SK-104FS(800\*600 )  
SK-104FE(800\*600 )

The default model is SK-070FS(800\*480), the screen resolution (800 \* 480) in the bracket is not displayed in the dialog box.

Display mode: Display direction of the touch screen used by the project. Available models include:  
 Horizontal: Configuration with the touch screen being horizontal.  
 Vertical: Configuration with the touch screen being vertical.  
 The default mode is Horizontal.

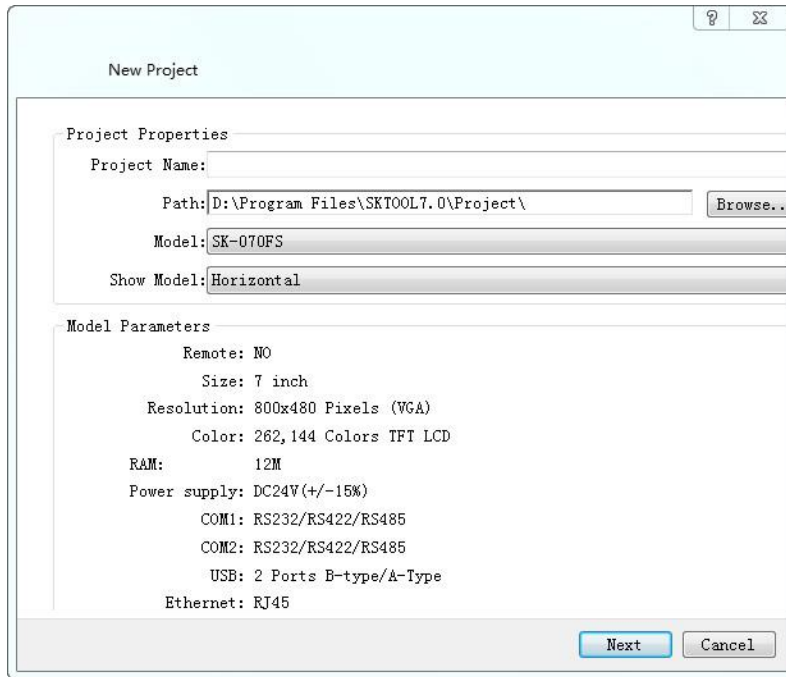

Figure 3-1 New project dialog box

The figure above is the New Project dialog box where engineers decide the Name, Path, Model and Display Mode, then click Next to set communication port.

Specific model is determined by the HMI model that user has.



The name of the new project cannot contain the following characters: \/: \* "<> |?.

The location of the new project cannot contain the following characters: \/: \* "<> |?.

### Communication Settings dialog box

Communication settings dialog box is used to set communication parameters of the communication port of HMI. Only correct communication parameters can ensure normal communication between PLC and touch screens. The specific communication parameters depend on the model of PLC to be connected.

Connection Name: The name of the communication port.

Device Service: Selection of PLC brand and CPU type.

Connection Interface: Select COM port or Ethernet port.

PLC Continuous Address Interval: Set PLC consecutive address space; the default value is recommended.

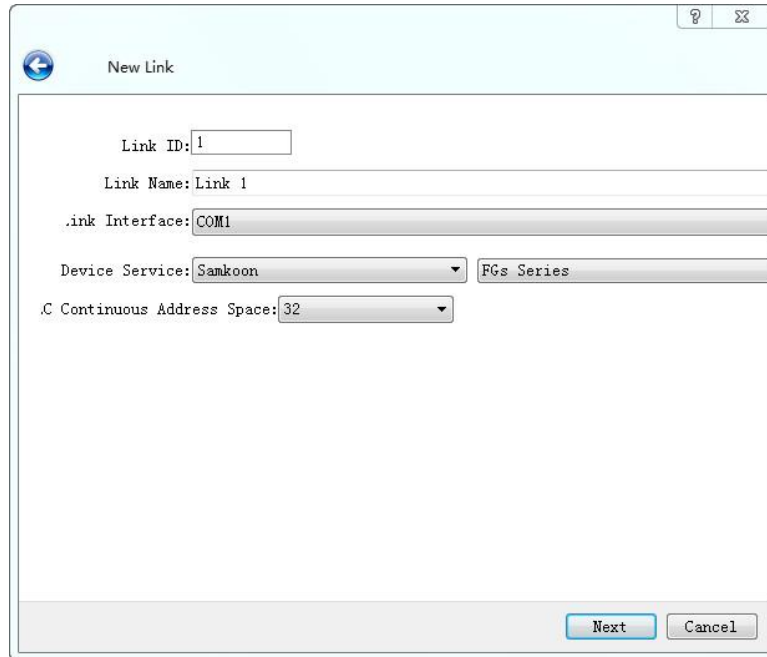

Figure 3-2 Communication setting dialog box

The figure above is the dialog box of communication port settings where engineers choose corresponding device services according to types of connection devices. To use Ethernet connection, choose "Direct Connection(Ethernet)" option in the "Connection Type".



SK-070F, SK-070H, SK-102H, SK-121F, they all have two communication ports; it's decided by the used port when connected to one PLC. SK-035F, SK-043F, SK-043H, SK-050H only have one COM port; just set COM1 port.

Connection ID: Internal parameters cannot be changed!

When you configure the communication properties can also be set in the Project Manager connection, the other parameters are set in the communication properties.

### 3. Screen Properties settings box

Click “Next” in the Communication settings dialog box to pop up a New Screen dialog box where you can set the name and the background color of screens. The default name is a screen number; the default background color is blue. When we create a new picture every time, SKTOOL configuration software will assign a screen number to the new screen to indicate the screen order of the current project. Numbers start from 1, that is, the serial number of the first frame 1. No. 5 is the fifth screen. To change the background color of the new screen, just click the rectangle behind the Background Color to bring up the color selection frame. With more than two hundred kinds of colors for users to select quickly, SKTOOL software provides the most extensive selection of color. If you are dissatisfied still, you can click on the lower right of the color selection box to customize color. In the Custom Colors dialog box, select the basic color first, then color in the middle of the square area; drag the mouse to adjust the desired color area; you can also type in the right vertical rectangle and drag the mouse to complete the desired color, at last click OK. You can also enter directly basic color values.

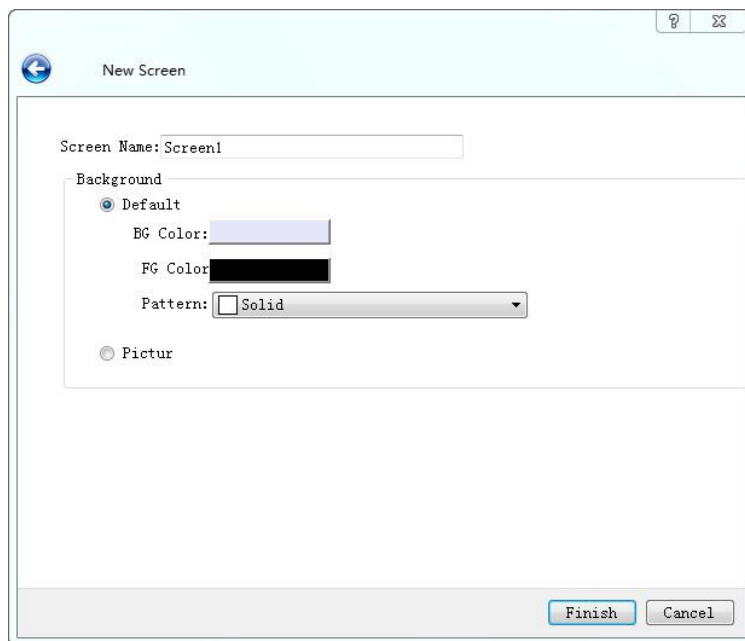

Figure 3-3 New screen dialog box



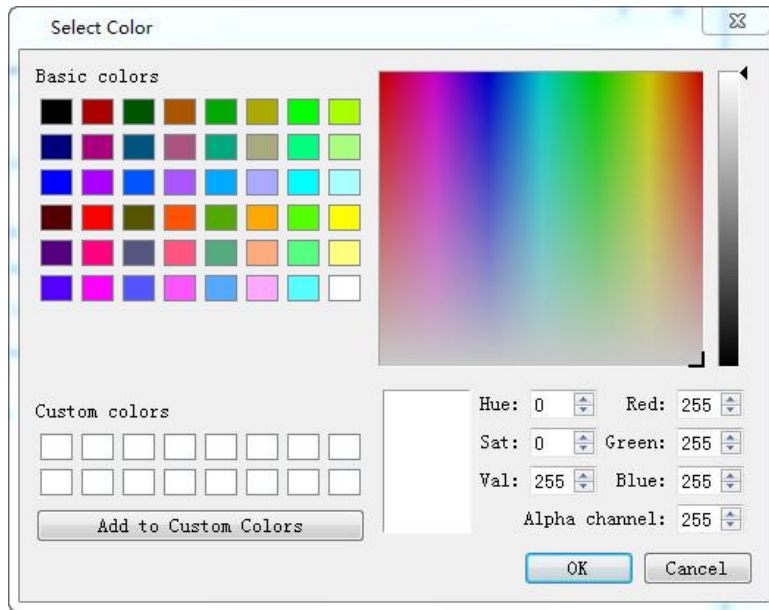

Figure 3-4 Color selection dialog box

Engineers can also choose own pictures as the screen background. Click the path icon to find the image path.



Figure 3-5 Set the path of picture

Click OK to complete the above steps, the system will immediately open the screen you just created. Preparations for new construction are done. Then it's time to edit own configuration project.

## 5.2 Set parameters and add graphic object



### Parameter settings:

1. You can modify the parameter settings through Preference Setting in the drop-down menu Settings, or double-click the [HMI Parameter Settings](#) in Setting, Project Manager. Then a pop-up dialog box is shown as Figure 3-6 below:

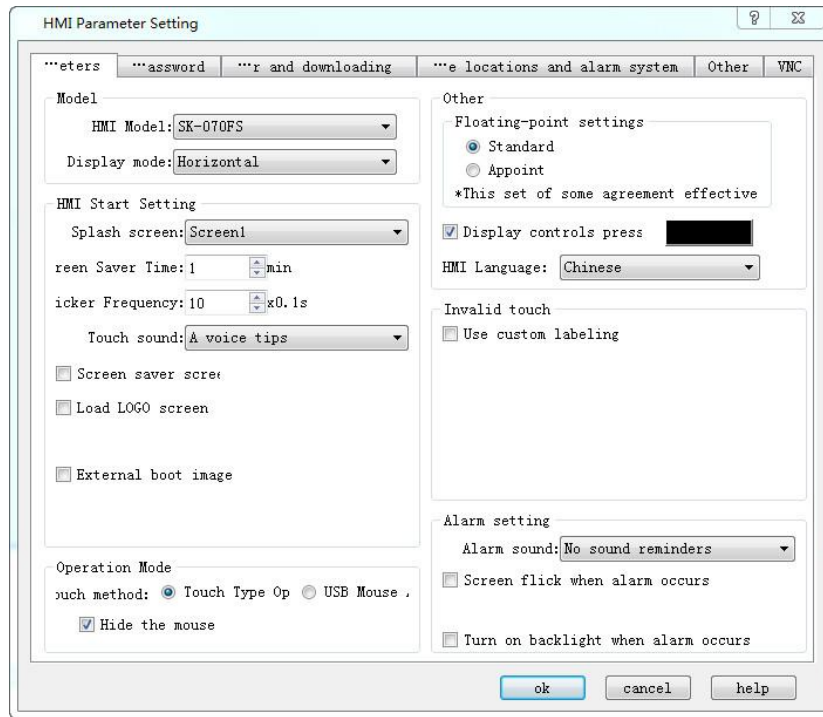

Figure 3-6 General parameter setting dialog box

- HMI Model: Change the HMI model through this option.
- Display mode: Adjust horizontal or vertical display screen.
- HMI Start Setting
  - Splash screen: The start screen of HMI when powered on
  - Screen Saver Time: Set screensaver time
  - Flicker Frequency: Set the flicker frequency of objects or controls which can blink; you can change the speed of flicker by inputting directly a value and clicking the spin button.
  - Alarm sound: When the alarm occurs, the touch screen can remind users through sound; the right drop-down menu contains two cases, with or without sound reminder.
  - Touch sound: Options in the right drop-down menu can decide Sound reminder or No sound reminder.
  - Screensavers screen: Select a screen among the existing screens as screensaver screen; just touch the screen to return the former screen.
  - If Load Screen: If choose this option, the HMI will display the selected loading screen after power-on for a certain while, and then switch to the splash screen; thus users can give some tips or notes.
- Other settings
  - Hide mouse cursor: Whether to display the mouse
  - Floating-point settings:
    - [Standard]: High byte floating point ahead while the low one behind;
    - [Appoint]: users determine the order.
  - Invalid touch: Select the "Use custom labeling", which means touchable controls cannot be touched, then the picture marking the control chosen by user is untouchable.
  - Display controls pressing effect: SKTOOL is newly added pressing effect display. When the pressing effect is applied, rectangular pressing trace will appear if users touch the control. The pressing trace color depends on user's preference. Currently Bit switch, Word switch, Screen button, Function button, Numeric input and ASCII input controls support this effect. The default is No effect.



Pressing effect of elliptical controls is still a rectangle.

Display controls pressing effect



Figure 3-7

## 2、Set user password

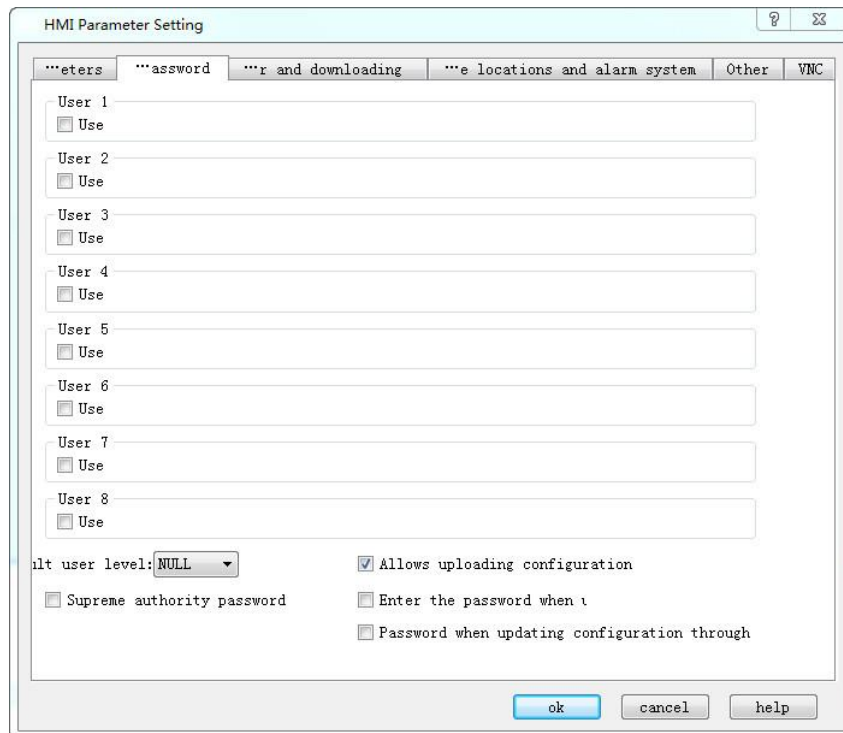

Figure 3-8 Set user password in HMI parameter setting dialog box

This function has 8 sets of user password, each of which has eight levels of password for users to choose.

- The default user level: The current default user class is NULL.
- Allow uploading configuration: If select this option, you can upload the project from HMI to PC; otherwise it cannot be uploaded.
- Enter the password when uploading: Whether uploading projects requires a password.
- Password when updating configuration through U disk: The password set up, the password is necessary when you update the HMI configuration projects through U disk.
- Supreme authority password: This password can operate all controls limited by grades.
- Upload: Whether this password enables upload configuration projects from HMI to PC.
- Permissions: Whether this password can perform all limiting operations.

## 3.Settings of connection to the printer and downloading

Click "Settings of connection between HMI and printer" button, as shown in Figure 3-9:

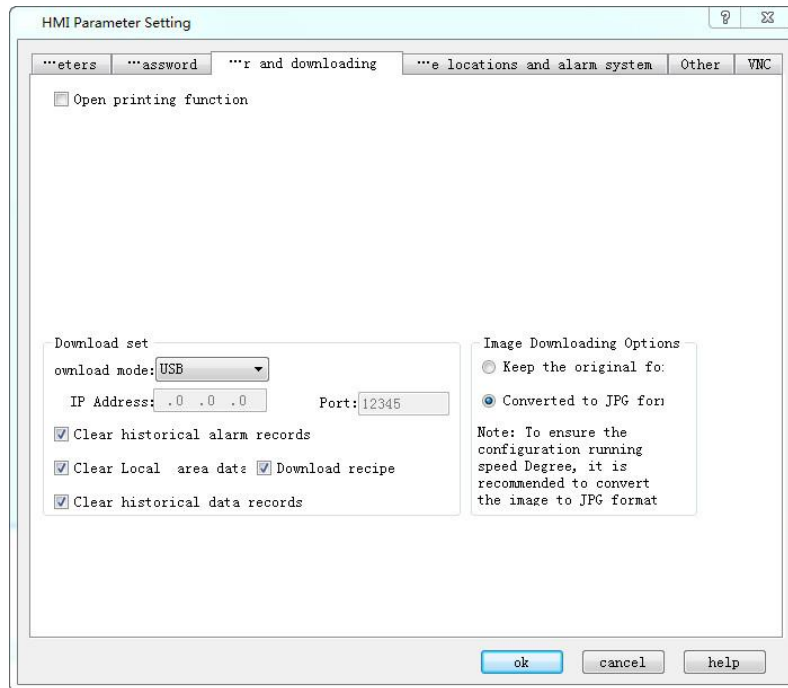

Figure3-9 Settings of connection between HMI and printer

This page contains parameter settings of connection between the printer and the HMI; users can select corresponding parameters according to printer models.

**Download settings:**

- Download mode: Users need to select USB or Ethernet connection to download. If choose the Ethernet, it's necessary to set the IP address and port number (IP address and port number are those of the HMI).
- Clear historical alarm records: Whether to clear the history alarm information before downloading.
- Clear historical data records: Whether to clear the history data information before downloading.
- Download Formula: Whether to download formulas in the current project to the HMI.

**Image Downloading Options:**

- Keep the original format: Selecting this option means retain the image format unchanged when downloading.
- Convert to JPG format: Convert all images to JPG format before downloading them into HMI. (Note: Due to the larger space occupied by BMP format images, it's suggested to select this option.)

4.Storage location and alarm system, as shown below

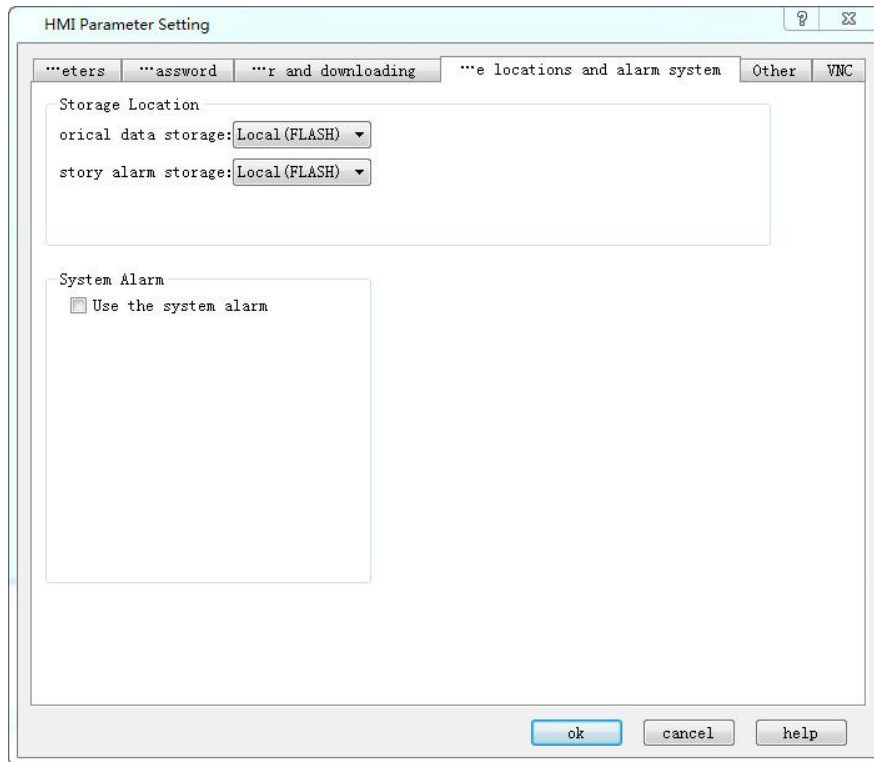

Figure 3-10 Saving position and system alarming setting dialog

- Storage location: Location for historical data, historical alarm and screen shots. Provide "Local (FLASH)", "U disk" three options for users to choose according to their need. The default is Local (FLASH).
- HMI IP: Set touch screen network parameters
- Alarm system

Use the alarm system: Whether to use the system alarm. When an alarm occurs, the alarm system displays the current alarm information at the top or bottom of each screen according to the options set by users.

Alarm background color, Text color, Font and Font size, these are attributes options of the alarm display system. Users can set these options as needed.

Way of display: "Always display" refers to the alarm displayed all the time; "Cyclic display" means that alarm display or disappear within a certain period to achieve the flicker effect.

Position of alarm bar: Choose the position where the alarm bar appears.

5. Other setting, as show below

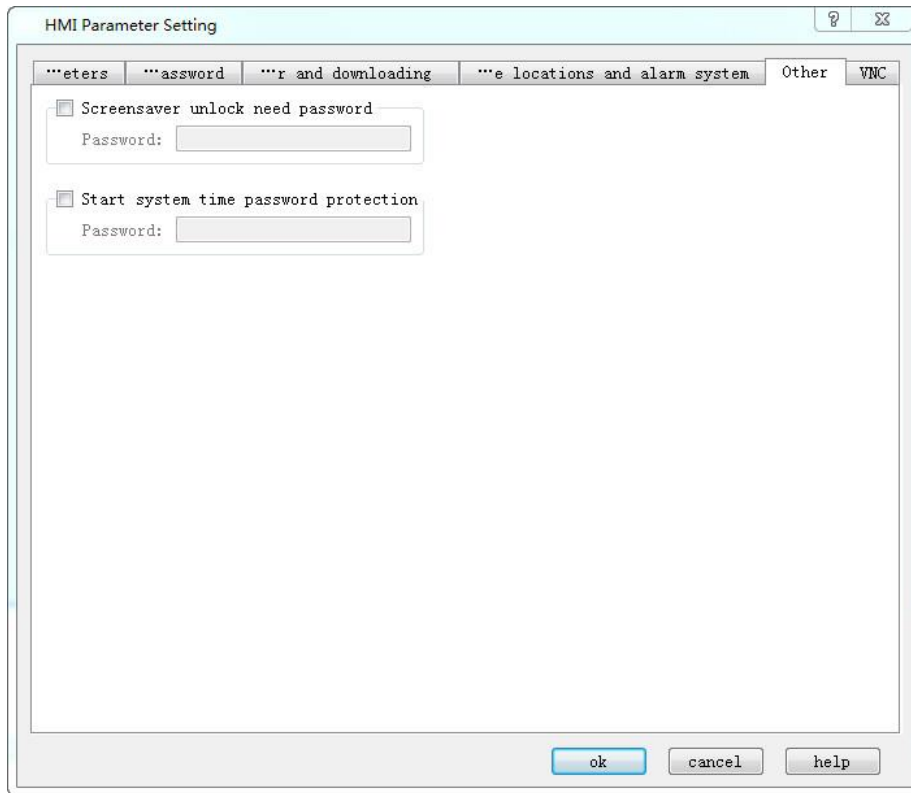
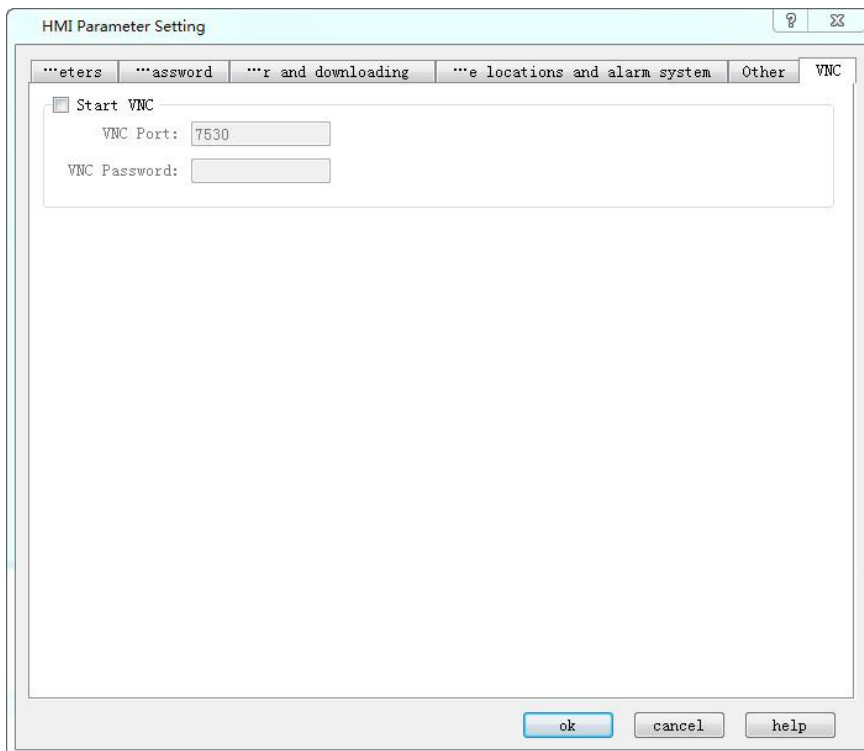

Figure 3-11 Screensaver unlock need password

- If checking out this section, user need to input this password when unlocking the screensaver.
- Start system time password protection: When you enable this option, you need to properly enter the password set here when modifying the touch screen system time, allowing the user to modify the touch screen system time

## 6. VNC Settings



- Start VNC: Enable VNC Settings
- VNC Port: Set the VNC port number

- VNC Password: Set the VNC connection password
- The special type touch screen supports remote through the VNC connection touch screen operation, detailed reference to the “VNC connection”



Change of the screen saver time is not valid until "Screensaver screen" is chosen; just touch the screen of screensaver to return to the former screen.

### 5.3 Download configuration engineering

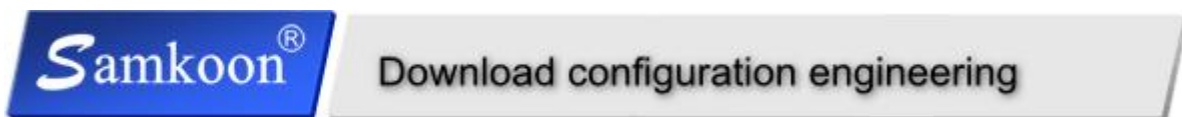



When complete the editing of configuration, you need to click the button  on the toolbar or employ the shortcut Ctrl + S, and then click  or execute the Compile command in the Download menu to compile. During the compilation, the information output window will show the situation in real time. It can't complete the compilation if error exists. As shown in Figure 3-11:



Figure 3-11 Prompt of compiling error

You can modify it according to the error hint in the information output window; or you can also double-click the error, then SKTOOL will automatically find the wrong object as well as select it. So engineers can double-click on the object to view its property settings, find the reason of the error and make appropriate alterations. After click the Save button to compile and execute the command again. If there is no error, the system will pop up a dialog box indicating successful compilation after a while. At last, click OK to finish it, as shown in Figure 3-12:

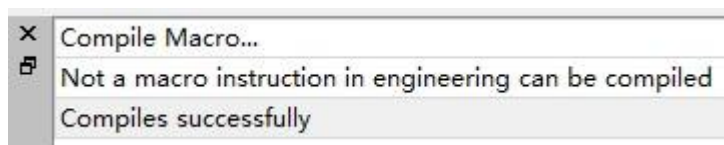

Figure 3-12 Information output window



It's necessary to compile before downloading while the step of conservation is required before compiling. Otherwise it will fail to compile, as shown in Figure 3-11. After compilation, if you modify again, you need to compile again.

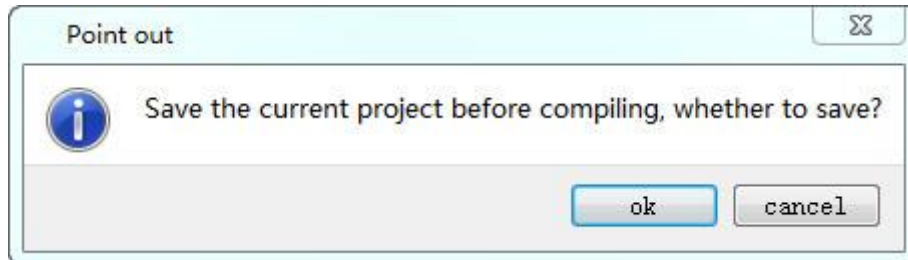

Figure 3-13 Compiling reminder

Finally, execute the command USB in Download menu to download through USB cable; engineers can also directly select the command Compile + Download in Download menu. The implementation of the operation brings up the following pop-up dialog box in Figure 3-12:

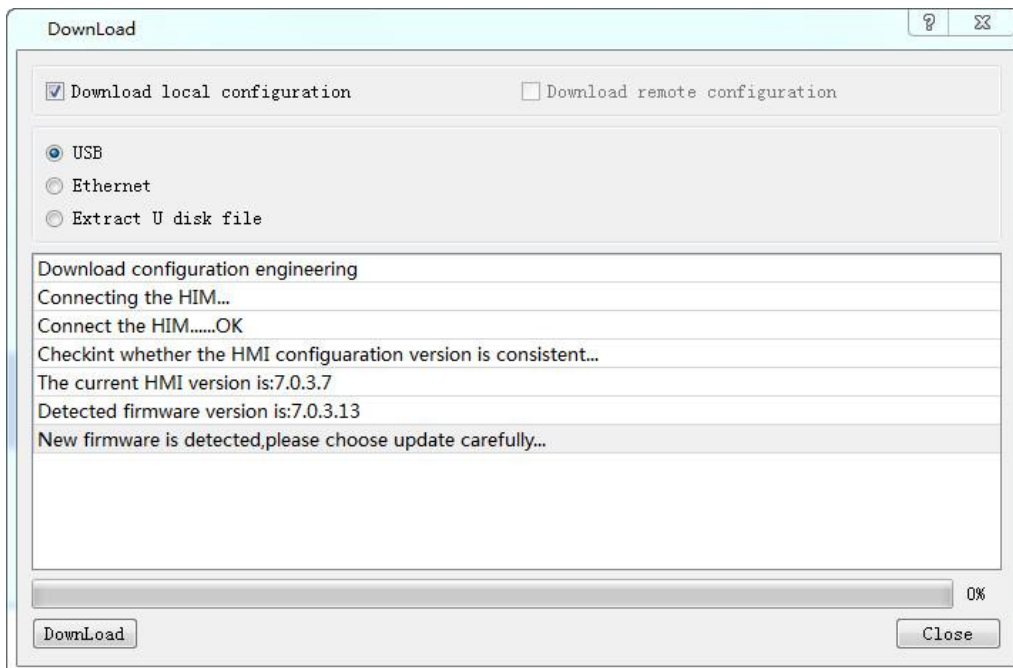

Figure 3-14 Download dialog

Click to download; the middle progress bar shows the downloading progress. After the downloading, a pop-up window shows the completion of USB download. Click OK to complete the downloading task, as shown in Figure 3-15:



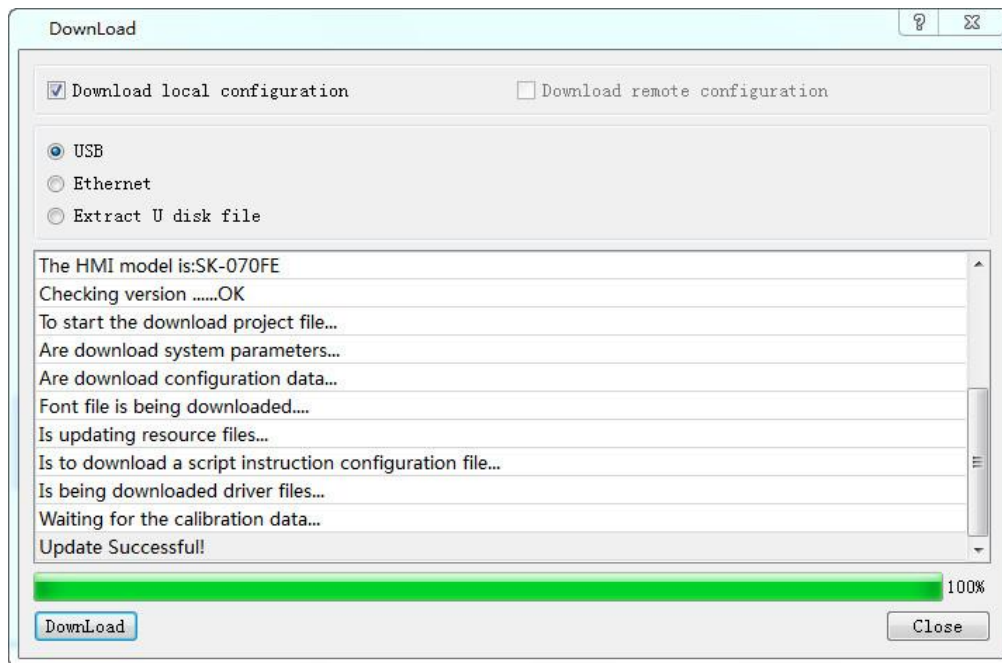

Figure 3-15 Downloading completed

The next step is the connection to the PLC to see whether the configuration project runs correctly in HMI.

Ways of connection between HMI and PLC or PC are shown in "Connection" in Hardware handbook.



Do not cut off the power of HMI, PC or USB cable and avoid other operations during the transmission process; otherwise it will be affected.

Please install the USB drivers before downloading; otherwise the PC will not be connected to HMI. Thus you will not be able to complete the downloading task.

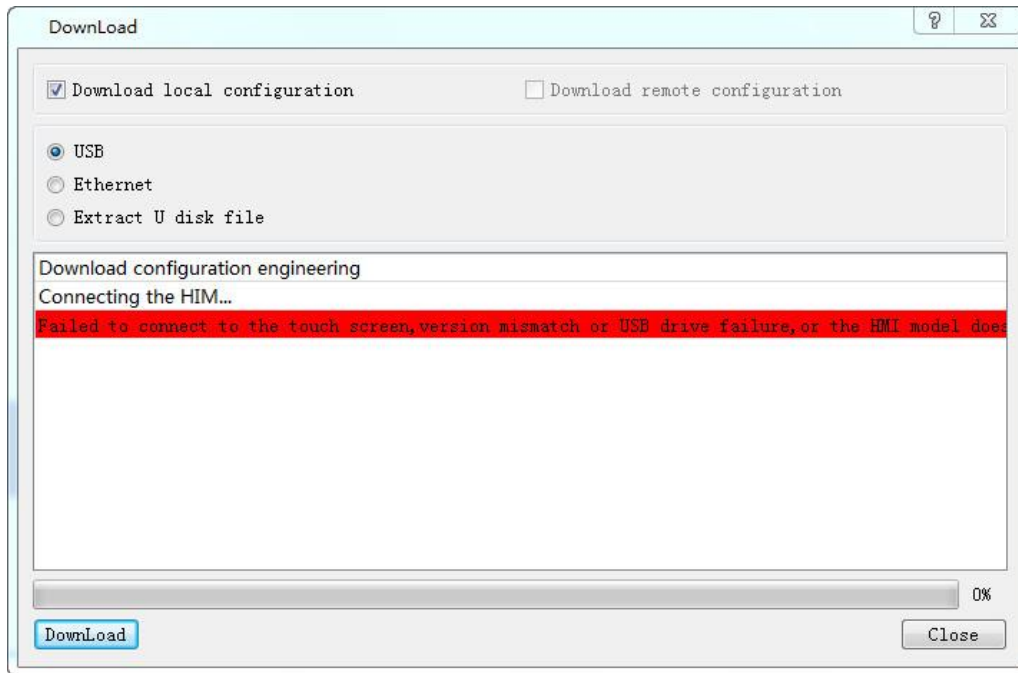

Figure 3-16 USB driver prompt



The pop-up dialog box, as shown in Figure 3-16, means that the PC does not recognize the HMI. Now it is necessary to check whether the USB driver has been installed: Connect the PC and power-on HMI, and then search “Samkoon HMI Tech Corp USB drive” in the Windows "My Computer" - "Properties" - "Hardware" - "Device Manager" - "Universal Serial Bus controllers". (you can try to pull out the USB cable to check if the PC can recognize HMI):

### Configuration downloading through Ethernet

- Set HMI network parameter settings

Open the dial switch 1 and 3 together; set the IP that can be set accordingly (here set it as 192.168.1.61), gateway, subnet and port. Fix the port to 12345.

- Compile the configuration

If select downloading configuration through Ethernet it is necessary to input IP address and port number in the input box. IP is that of the downloading target HMI. The IP here is 192.168.1.61 as above, and the port is fixed to 12345. Then click to restart and download, as shown in Figure 3-18:

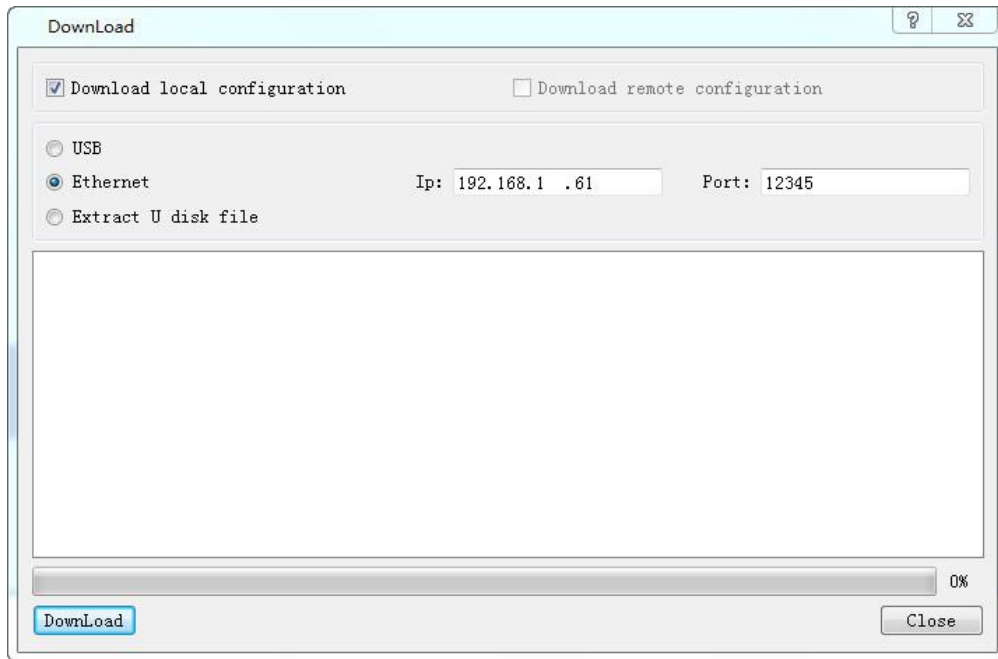
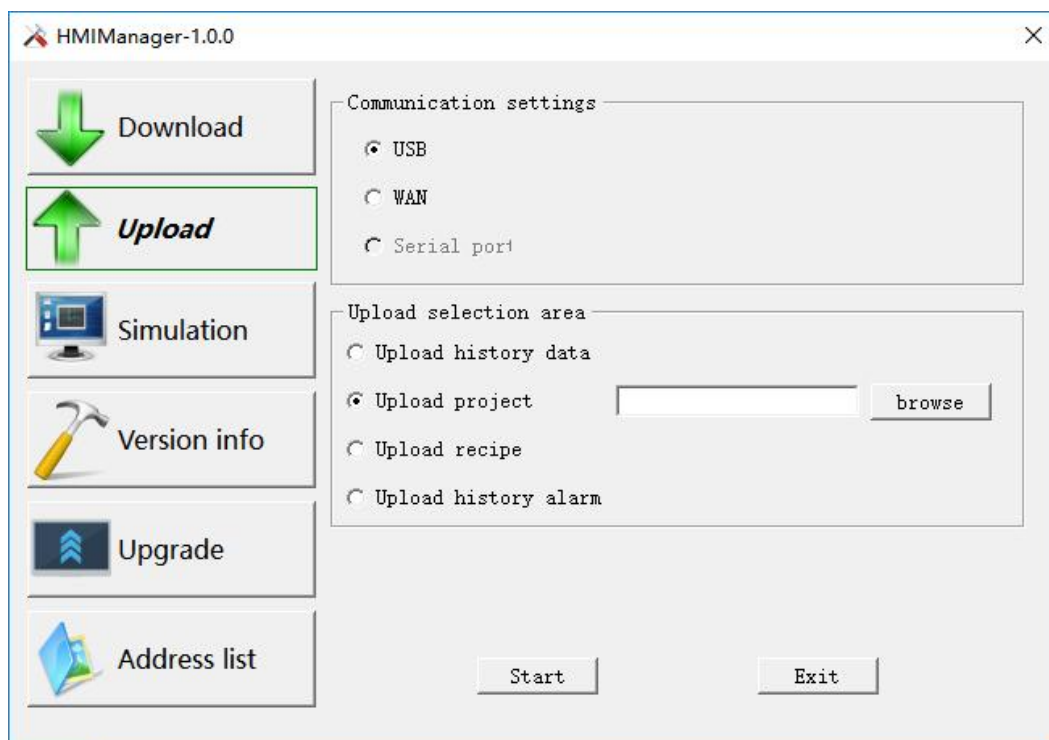

Figure 3-18 Configuration downloading through Ethernet

## 5.4 Upload configuration engineering



SKTOOL software supports uploading configuration program from the HMI to the hard disk. Connect HMI to PC; select the option of "Upload project file" in the pop-up dialog box, and then the user interface of "Upload Samdraw file" will appear.



- File Path: Click "Browse" to select the file in which you want to save the path.
- Project Name: Set the name of the project.
- Start uploading: Click Upload file to start.

After the success of the uploading, you can choose whether to open the project file.



It needs to extract the uploaded file before open it.

## 5.5 Upload historical data record

### Upload historical data record



Run SKTOOL configuration software; click

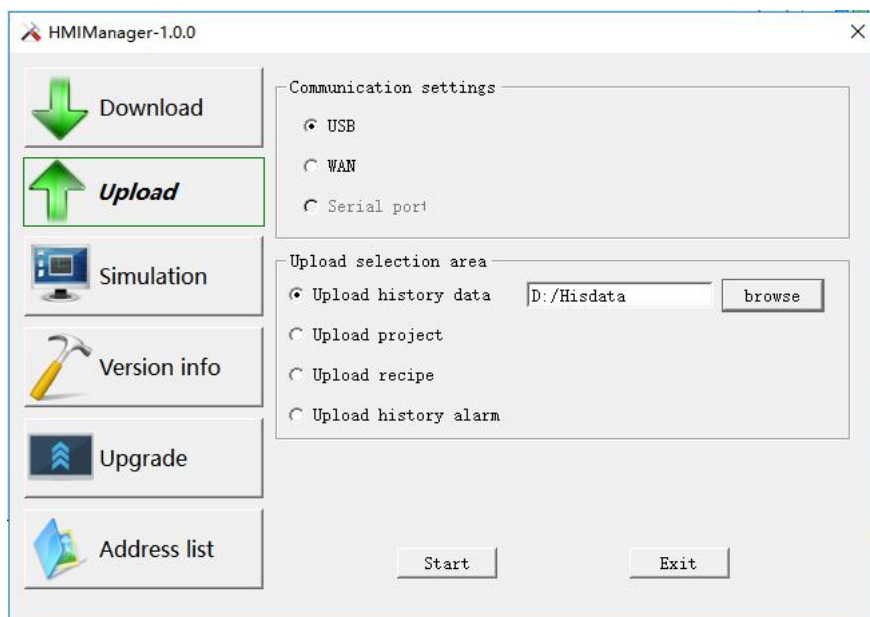

Selecting "Upload historical data record" means uploading it from HMI to the hard disk.

- File Path: Storage location; select "Browse" to choose your storage path.
- File name: Name of the uploaded file; the uploaded file cannot be opened directly, so a data conversion tool is necessary. Refer to "Export historical data and alarm to U disk" in the Help appendix for specific operation.

- Click "Upload File" to start uploading while the file is stored in the set location.
- SKTOOL newly add multiple set of historical data, so uploading historical data means, in addition to uploading historical database file, and also saving each set of historical data in the database file as a .CSV file. E.g., uploading a file called " temp ", then the according historical database file is named "temp", and that of CSV in group 0 is "temp\_hisdata0.csv" while that of CSV in group 1 is "temp\_hisdata1.csv", and so on.



Operation of uploading historical data record is similar to that of uploading formula and project file; the function of converting files from Samdraw3.3 to SKTOOL is disabled.

## 5.6 Pack/Unpack

---

Select "Pack/Unpack" in the Download menu to open the dialog box.

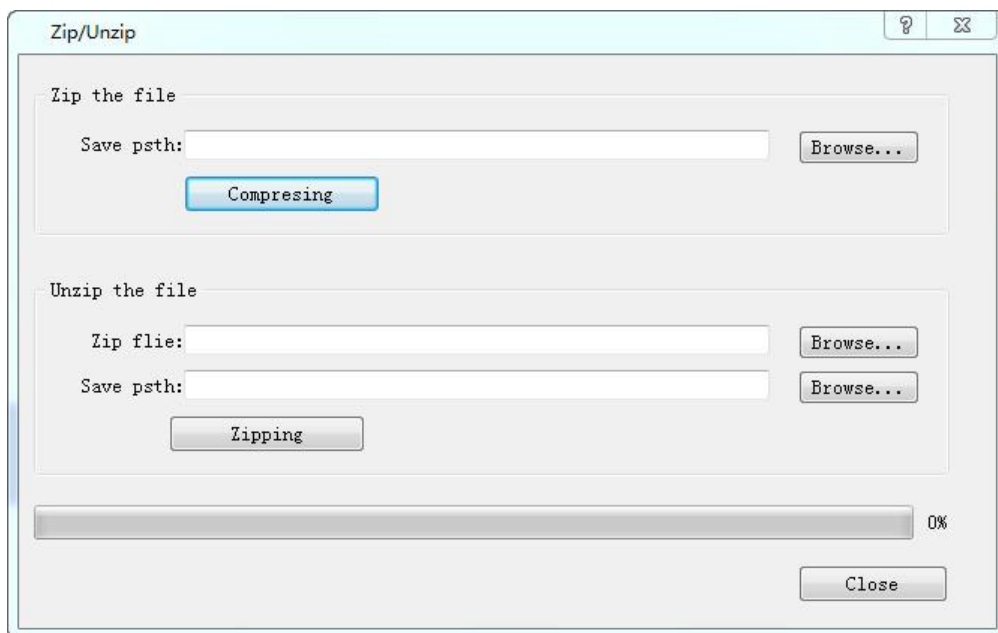

- Zip the file: Zip the SK project file to generate a compressed file suffixed .sip. Used external images will be also packaged into the compressed file. If users send the compressed file to another computer, the images still exist after unzipping. However, if only send the configuration project file, you will lose external images in other computers because the external images could not find the original image path.
- Save Path: Location to store the compressed file; after selecting the save path, Click "Compression", and then close it when the progress bar reaches 100%.

- 
- Unzip the file: Decompress a file-suffixed .skr into that of .skm which can be opened directly in SKTOOL.
  - Zip file: Choose files to be extracted.
  - Save Path: Location to store the decompressed file suffixed .skm; after selecting the save path, Click "Zipping", and then close it when the progress bar reaches 100%.

---

## 6. SKTOOL Configuration Guide

---

This chapter introduces in detail the configuration methods using SKTOOL software.

### Contents:

- [Screen Operations](#)
- [Graphics editing commands](#)
- [Graphics editing commands](#)
- [Basic controls](#)
- [Advanced controls](#)
- [New controls](#)
- [SKTOOL Control Instructions](#)

### 6.1 Screen Operations

---

This chapter details screen operations of SKTOOL configuration.

### Contents:

- [Create a New Screen](#)
- [Modify Screen Property](#)
- [Delete Screen](#)
- [Delete Screen](#)
- [Automatic sorting](#)

## 6.1.1 Create a New Screen



“New Screen” command is used to create a new screen in the current project. Steps of creating new screens are as follows:

1. Select the “New Screen” command in the Screen menu or click the button command  or right click the Screen menu in the project manager, and then select “Add Screen”, as shown in Figure 4 -1 below:

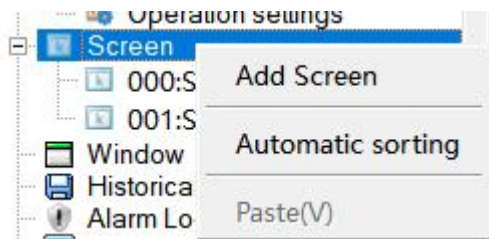

Figure 4-1 New Screen

2. In the pop-up "New Screen" dialog box, set the name and background color of the new screen, then click OK. The default name of the new screen is a screen number; the default background color is blue, as shown in Figure 4-2:

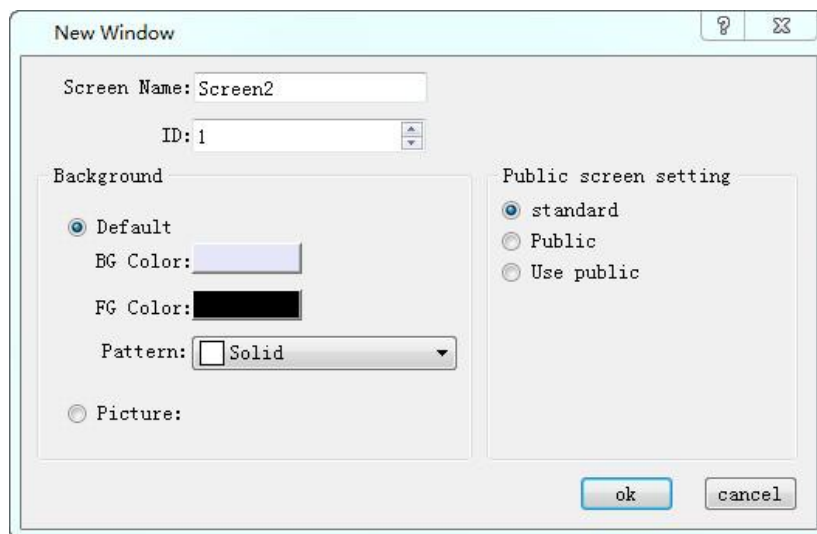

Figure 4-2 Add screen dialog



Standard: Standard picture

Public: Public screen can be used many times, the control property can only be modified in this picture

Use public: Use a public picture that has been created, but cannot modify the properties of the control in its public screen

The Background color, Foreground color and Pattern of new screen can be set.

Picture: Picture can be set as background of new screen.

## 6.1.2 Modify Screen Property



To modify the properties of the screen, including the name, background color, you can perform the following operations:

Under the circumstances that no object or control is selected (you can click blank space in the current screen), select the  command on the toolbar or left click to select the screen in the project manager, and then right click on it or you can right click in the screen while on object is selected in order to bring up the context menu in which you can find "Property" command.

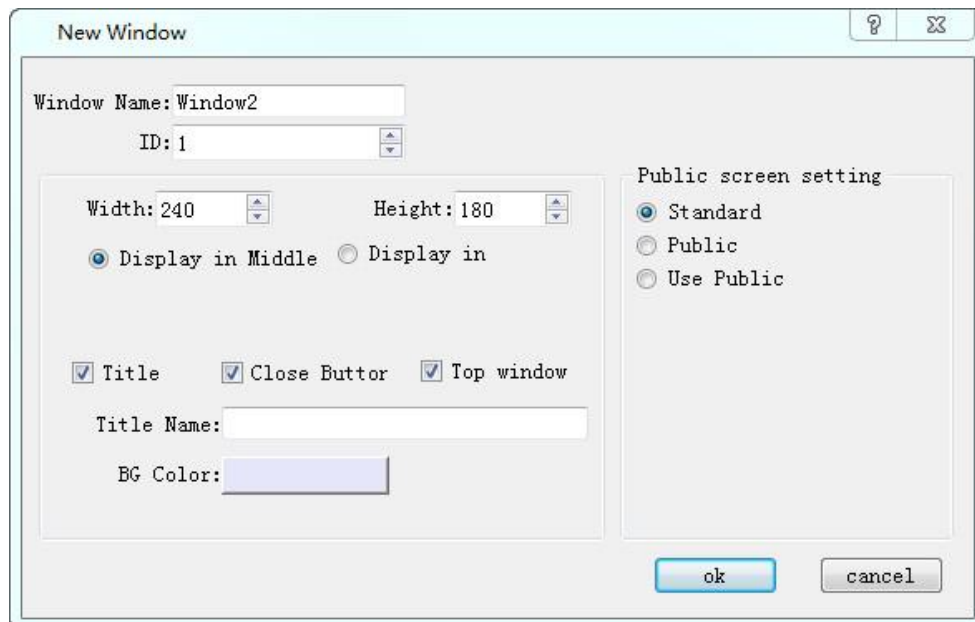

Figure 4-3 Screen Property settings

In the "New Screen" dialog box, set the name of the new screen, background color and public screen settings, and then click OK. The default new screen name is the screen number.

Default: set the background color, foreground color and style of the screen.

Photo: picture can be used as background.

Public picture settings

Standard screen: create a standard screen.

Set it to a public screen: Create a public screen in which the controls can be used on other screens, but the properties of the controls can only be modified on that screen.

Use the Common Screen: Use the created Common Screen, but do not modify the properties of the controls in the Common Screen.

### 6.1.3 Delete Screen



This command is used to delete the screen in the current project; methods are as follows:

Select " Delete Screen" in the Screen menu; or left-click to choose the screen to be delete in the project manager, then right click to select "Delete" key; or right click in the blank space in the screen while on object is selected in order to bring up the context menu in which you can find "Delete" command.

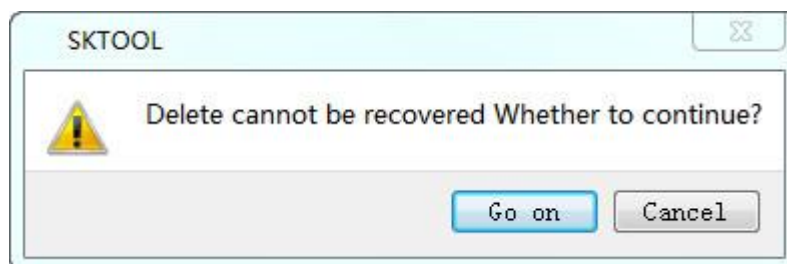

Figure 4-4 Delete screen

Click OK to complete the operation of deleting.



Once deleted, the screen cannot get back! Execute this command with caution.

## 6.1.4 Copy Screen



This command is to copy the screen in current project; methods are as follows:

Left-click on the screen to be copy in the project manager, then right click to bring up the context menu and select "Copy", after that right click to bring up the context menu and select "Paste"(Figure 4-5). It would create a new screen copying from the assigned one.

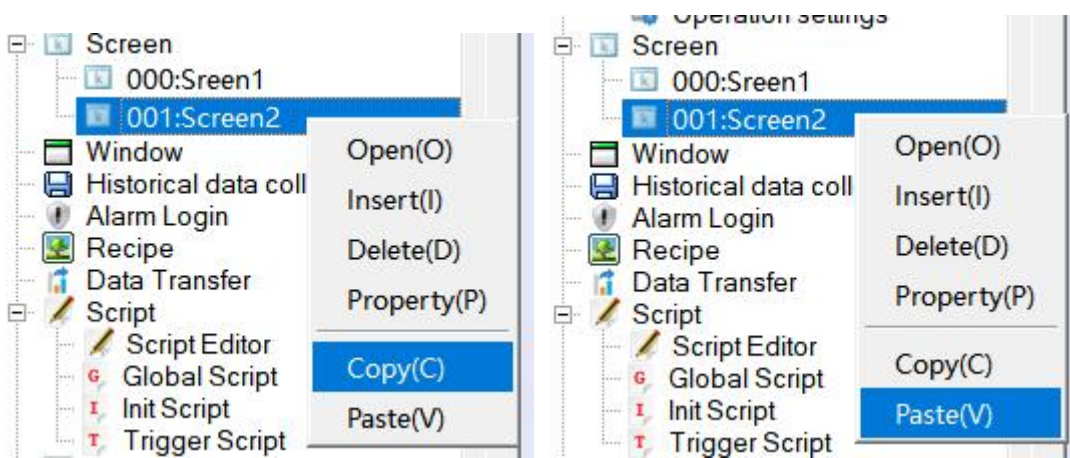
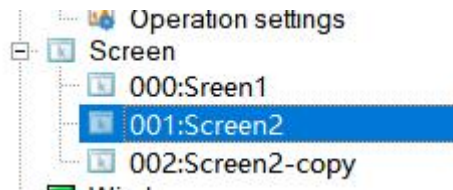

Figure 4-5 Copy and Paste Screen



## 6.1.5 Automatic sorting



“Automatic sorting” command is used to create a new screen in the current project. Steps of creating new screens are as follows:

The automatic sort command is used to sort the picture number in the current picture. Methods are as

follows:

Select the project manager the picture option by clicking the left mouse button, then right-click menu select "automatic sorting and automatic sorting will prompt the settings screen, select the automatic sorting function, click OK, can carry out sorting operation on the current screen (from small to large order).

The specific process is shown in the following picture:

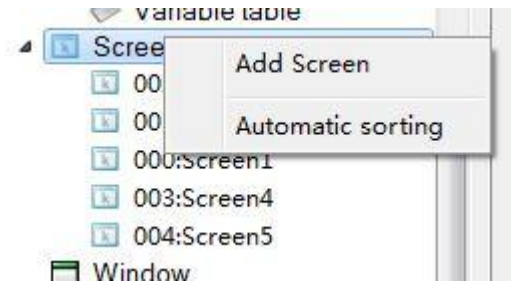

Click the left mouse button options, right-click select "automatic sorting."



Check the automatic sorting, click OK



## 6.2 Graphics editing commands

---

This chapter details SKTOOL graphical editing commands.

Contents:

- [Group and Ungroup](#)
- [Layer](#)

- Rotaty
- Align

## 6.2.1 Group and Ungroup



The combination command is a group command, which is to combine 2 or more graphics objects and controls in the current screen into a graphic object, a whole, and 2. The contents of the combination can be graphics drawn by engineering designers, or drawn by themselves, or can be system library graphics, or other controls, such as alarm controls, trends, and so on. After the combination control, keep the property of the original control object, which can be modified. The cancellation combination is to decompose the graph which is combined with the combination command into several original combination elements, and cancel the combination command is the reverse operation of the combination command.

### Methods of Grouping:

First it needs to select multiple graphic objects, and then select the Group command  in the Edit menu, or that command button in the toolbar menu, or right click to bring up the context menu and select "Group" item, before and after comparison picture is as Figure 4-6:

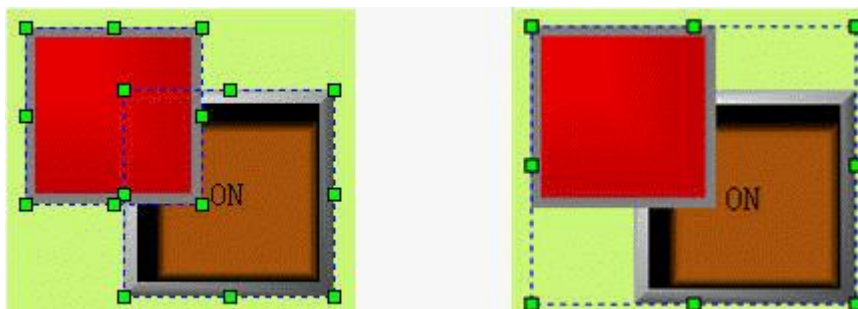



Figure 4-6before and after group command

### Methods of ungrouping:

Select a combined graphic object from grouping, and then select the Ungroup command  in the Edit menu, or in the toolbar menu, or in the context menu; before and after comparison picture is as Figure 4-7:

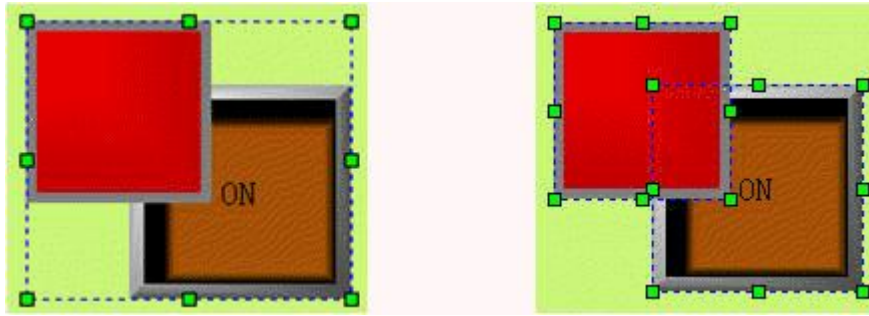

Figure 4-7 before and after ungroup command



Select multiple objects through Ctrl key.

## 6.2.2 Layer

### Layer



Layer Command is by group. It is used to adjust the display level of intersecting graphic objects. Each object SKTOOL has a graphic level; the top of the graphic objects are always displayed on top of the lower graphic objects, so you can use this command to adjust the hierarchy level. The default level of new graphic object is higher than that of original. SKTOOL Layer consists a total of four commands: Bring To Top, Bring Forward, Send to Bottom and Send Backward. To execute this command, you need first select one or more graphical objects on the current screen, and then select the corresponding command in the Edit menu or toolbar menu.

#### ➤ Bring To Top

Execute this command to move the selected graphic object to the uppermost layer of all graphic objects, so that the selected graphic object will overwrite the intersecting part.

First choose an object in several graphs, and then choose Bring To Top command in Edit menu, or command

button  in the toolbar buttons, or call the right click menu and choose Bring To Top command in the Layer option. See Figure 4-8 for a comparison before and after combination.

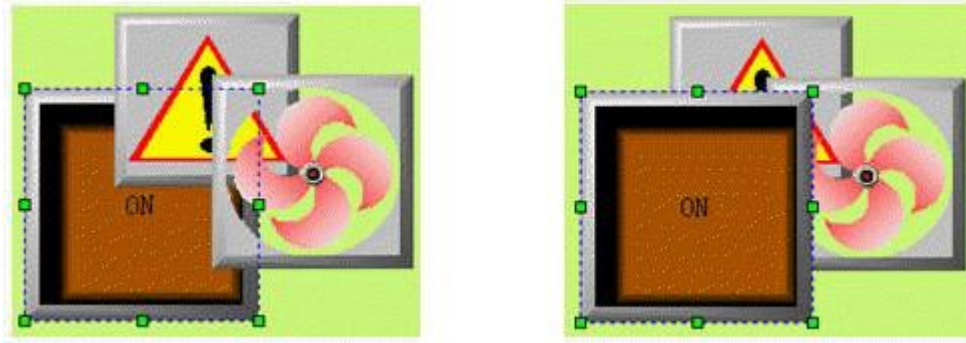



Figure 4-8 Contrast before and after Bring To Top

➤ **Send To Bottom**

Execute this command to send the selected graphic object to the lowermost layer of all graphic objects, so that the intersecting part of the selected object will be invisible.

First choose an object in several graphs, and then choose Send To Bottom command in Edit menu, or command button  in the toolbar buttons, or call the right click menu and choose Send To Bottom command in the Layer option. See Figure 4-9 for a comparison before and after combination.

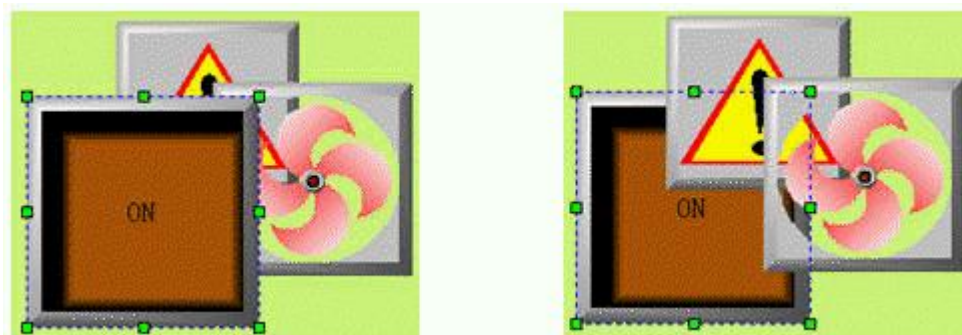



Figure 4-9 Contrast before and after Send To Bottom

➤ **Bring Forward**

Execute this command to bring the selected graphic object one level forward to the intersecting graphic objects. You first need to select one object in multiple graphic objects, and then select "Bring forward" in the Edit menu or the toolbar button, or right click to bring up the context menu containing "Bring forward" in the series commands of Layer.

First choose an object in several graphs, and then choose Bring Forward command in Edit menu, or command button  in the toolbar buttons, or call the right click menu and choose Bring Forward command in the

Layer option. See Figure 4-10 for a comparison before and after combination.

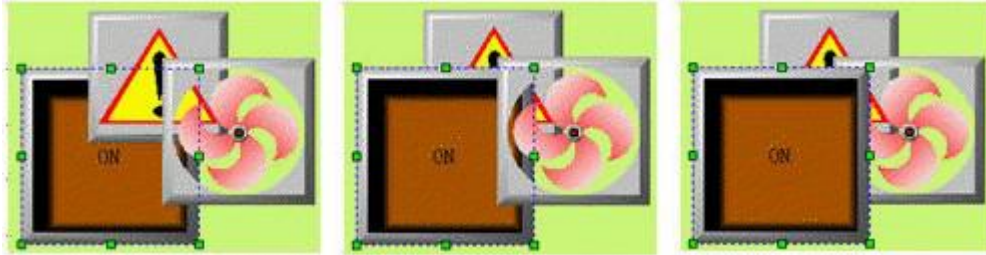



Figure 4-10 Contrast before and after Bring Forward

### ➤ Send Backward

Execute this command to send the selected graphic object one level backward to the intersecting graphic objects. You first need to select one object in multiple graphic objects, and then select " Send backward" in the Edit menu or the toolbar button, or right click to bring up the context menu containing "Send backward" in the series commands of Layer.

First choose an object in several graphs, and then choose Send Backward command in Edit menu, or command button  in the toolbar buttons, or call the right click menu and choose Send Backward command in the Layer option. See Figure 4-9 for a comparison before and after combination.

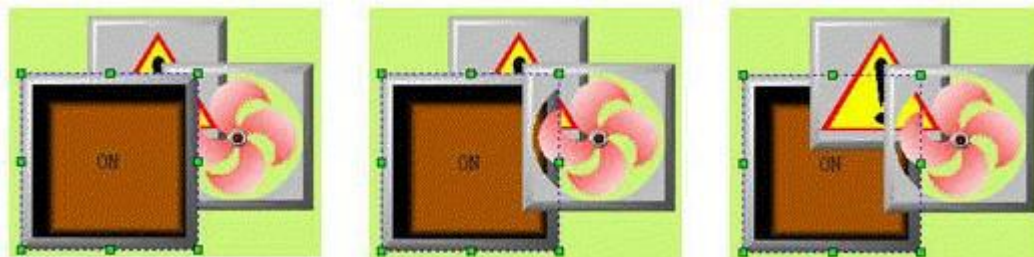

Figure 4-11 Contrast before and after Send Forward

## 6.2.3 Rotaty



This command is by group. SKTOOL configuration editor software allows engineers to rotate one or more graphical objects at any angle. Graphic objects that can be rotated to contain straight lines, circles, rectangles, graphics system library, controls, a combination of graphics, and polygons.

### ➤ Flip Horizontal



“Flip horizontal” allows engineers to rotate the graphic object (may be a plurality of graphic objects) at 180° by the axis of vertical center in the horizontal plane after selecting. First select one or more graphical objects, then click “Flip Horizontal” in the Edit menu "Mirror" or click the Flip Horizontal button in the Tool bar . When a single graphic object is selected, as shown in Figure 4-12:



Figure 4-12 Contrast before and after Flip Horizontal of single graph object

➤ **Flip Vertical**

“Flip Vertical” allow engineers to rotate the graphic object (may be a plurality of graphic objects) at 180° by the axis of horizontal center in the vertical plane after selecting. First select one or more graphical objects, then click “Flip Vertical” in the Edit menu "Mirror" or click the Flip Vertical button in the Tool bar . When a single graphic object is selected, as shown in Figure 4-14:



Figure 4-14 Contrast before and after Flip Vertical of single graph object

➤ **Rotating**

Currently, only the following 12 controls are supported to support this function:

Time Display、Date Display、Week Display、Static Picture、GIF Display、Picture、Numentric Display、Numerical Input、ASCII Display、ASCII Entry、MultiState Lamp、MultiState Switch

After rotation allows engineering design personnel selection controls, to object center as the dot, memory 360 °.Select an object, click the "rotate" command in the edit menu, or click the rotate button

in the tools button 

Rotation process

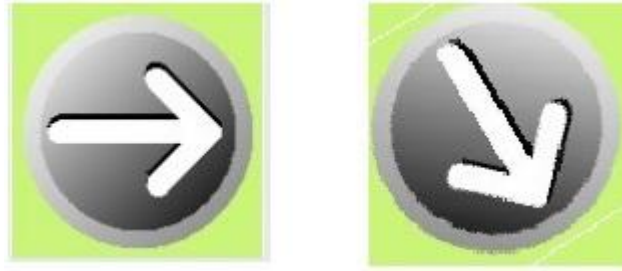

## 6.2.4 Align

### Alignment and Size



This command is by group, so is the Size. SKTOOL configuration software allows engineers to operate alignment and size operation on multiple graphical objects, but only when multiple graphic objects are selected. Users can hold down the key Ctrl to select the graphic objects to be aligned, or hold down the left mouse button and drag to delineate them. Alignment operations include a large number of editing commands: Left, Right, Vertical Center, Horizontal Center, Top, Bottom, Horizontal Equal Interval and Vertical Equal Interval, Make same width, Make same height, Make same height and width, etc.



The command of Top Alignment allows engineering designers to top justify multiple graphic objects (no less than two graphical objects) through clicking “Top” of the Alignment in the Edit menu or through the context menu. These graphic objects will take the highest edge of graphic objects as a reference, and then make them at the same level. Before and after comparison diagram of Top Alignment is shown in Figure 4-16:

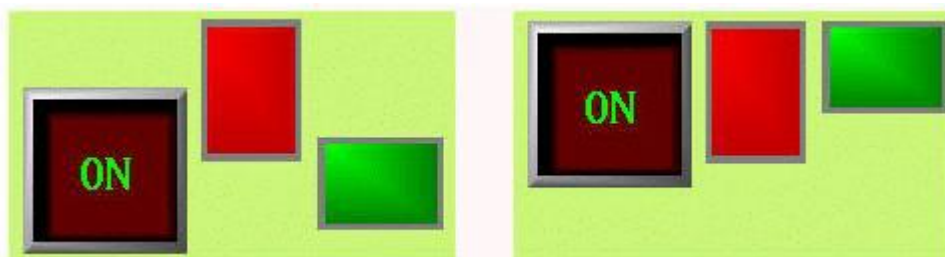

Figure 4-16 Before and after comparison diagram of Top Alignment



The command of Bottom Alignment allows engineering designers to bottom justify multiple graphic objects (no less than two graphical objects) through clicking “Bottom” of the Alignment in the Edit menu or through the context menu. These graphic objects will take the lowest edge of graphic objects as a reference, and then make them at the same level.

Before and after comparison diagram of Bottom Alignment is shown in Figure 4-17:

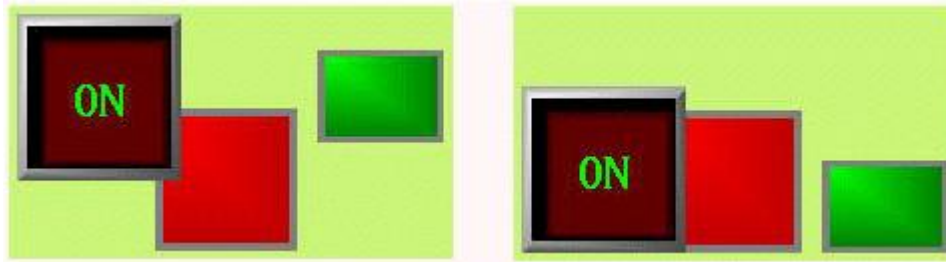

Figure 4-17 Before and after comparison diagram of Bottom Alignment

➤  **Vertical Center**

The command of Vertical center allows engineering designers to make centers of graphical objects in the same vertical line (no less than two graphical objects) through clicking “Vertical center” of the Alignment in the Edit menu or through the context menu. This vertical line is the vertical centerline of the leftmost and rightmost edges.

Before and after comparison diagram of Vertical Center Alignment is shown in Figure 4-18:



Figure 4-18 Before and after comparison diagram of Vertical Center Alignment

➤  **Left**

The command of Left Alignment allows engineering designers to left justify multiple graphic objects (no less than two graphical objects) through clicking “left” of the Alignment in the Edit menu or through the context menu. These graphic objects will take the leftmost edge of graphic objects as a reference, and then make the left sides of each graphic object along the same vertical line.

Before and after comparison diagram of Left Alignment is shown in Figure 4-19:

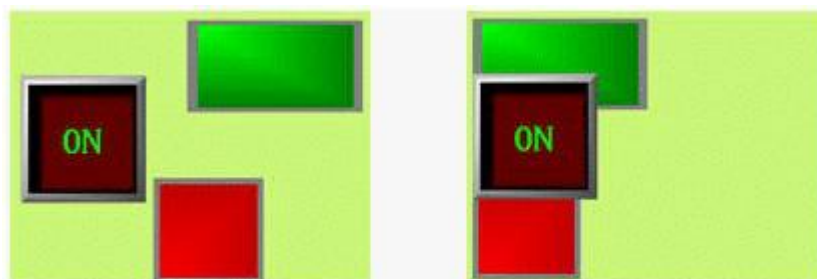

Figure 4-19 Before and after comparison diagram of Left Alignment

➤  **Right**

The command of Right Alignment allows engineering designers to right justify multiple graphic objects (no less than two graphical objects) through clicking “Right” of the Alignment in the Edit menu or through the context menu. These graphic objects will take the rightmost edge of graphic objects as a reference, and then make the right sides of each graphic object along the same vertical line.

Before and after comparison diagram of Right Alignment is shown in Figure 4-20:

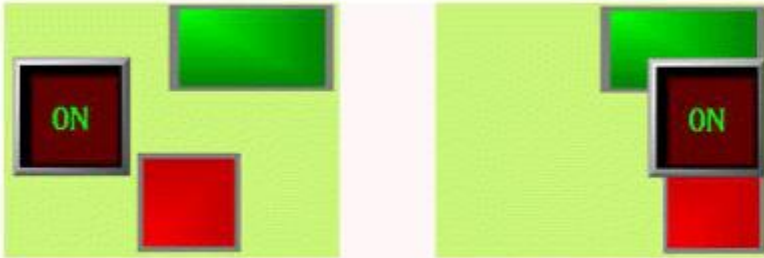

Figure 4-20 Before and after comparison diagram of Right Alignment

➤  **Make same width**

This command allows engineering designers to make multiple graphic objects (no less than two graphical objects) have the same width through clicking “Make same width” of the Size in the Edit menu or through the context menu. These graphical objects will be reduced or enlarged by the upper left point while the height remains unchanged, so that the width of each graphic object is in accordance with what has been selected before (surrounded by black points while others by green points).

Before and after comparison diagram of Make same width is shown in Figure 4-21:

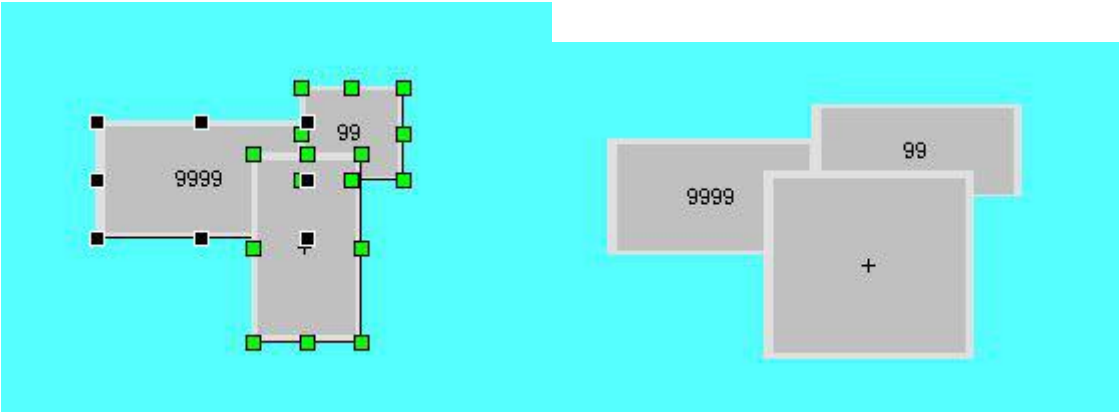

Figure 4-21 Before and after comparison diagram of Make same width

➤  **Make same height**

This command allows engineering designers to make multiple graphic objects (no less than two graphical objects) have the same height through clicking “Make same height” of the Size in the Edit menu or through the context menu. These graphical objects will be reduced or enlarged by the upper left point while the width remains unchanged, so that the height of each graphic object is in accordance with what has been selected before (surrounded by black points while others by green points).

Before and after comparison diagram of Make same height is shown in Figure 4-22:

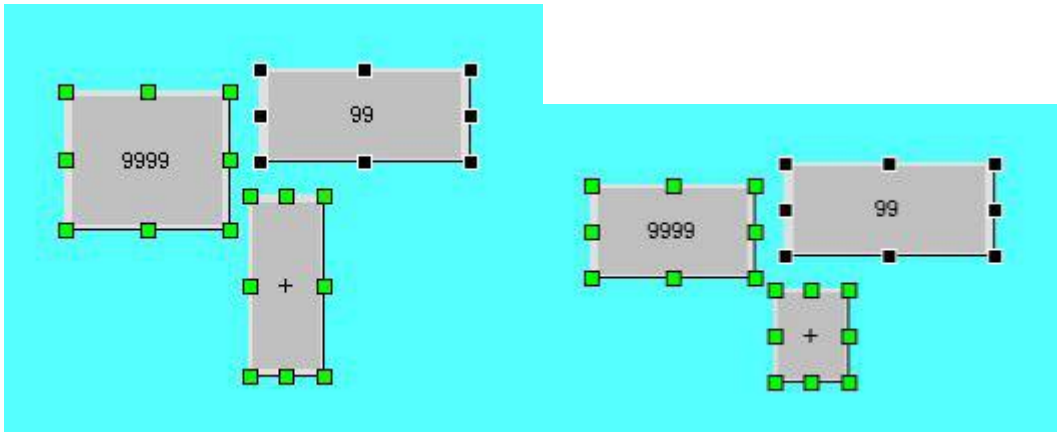



Figure 4-22 Before and after comparison diagram of Make same height

➤  **Make same height and width**

This command allows engineering designers to make multiple graphic objects (no less than two graphical objects) have the same height and width through clicking “Make same height and width” of the Size in the Edit menu or through the context menu. These graphical objects will be reduced or enlarged by the upper left point, so that the height and width of each graphic object is in accordance with what has been selected before (surrounded by black points while others by green points).

Before and after comparison diagram of Make same height and width is shown in Figure 4-23:

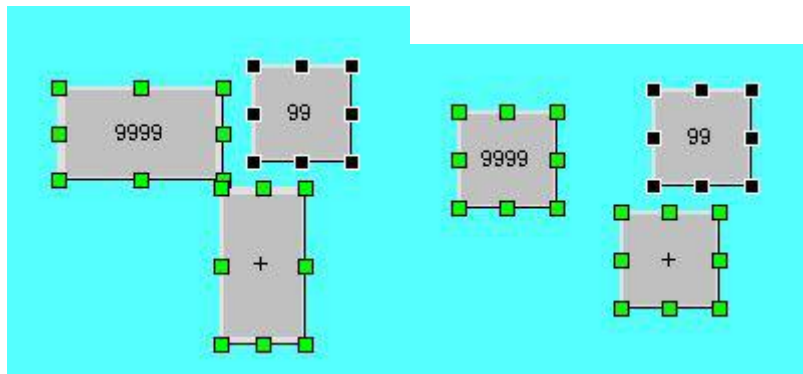

Figure 4-23 Before and after comparison diagram of Make same height and width

➤  **Horizontal Equal Interval**

This command allows engineering designers to make multiple graphic objects (no less than two graphical objects) have the equal interval horizontally through clicking “Horizontal Equal Interval” of the Alignment in the Edit menu or through the context menu.

➤  **Vertical Equal Interval**

This command allows engineering designers to make multiple graphic objects (no less than two graphical objects) have the equal interval vertically through clicking “Vertical Equal Interval” of the Alignment in the Edit menu or through the context menu.



---

Before executing commands of Make same width, same height, same width and height, please make sure whether the selected objects have been rotated. The height and width of rotated object also rotate with itself.

## 6.3 Draw Basic graphics

---

This chapter details operations of drawing basic graphics with SKTOOL.

### Contents:

- [Line](#)
- [Polyline](#)
- [Curve / Arc](#)
- [Free Line](#)
- [Rectangle](#)
- [Rounded Rectangle](#)
- [Circle/Ellipse](#)
- [Polygon](#)
- [Sector](#)
- [Text](#)
- [Table](#)
- [Scale](#)
- [Open Library](#)
- [Save to Library](#)
- [Regular polygon](#)

### 6.3.1 Line



Select the “Line” command in Draw menu or left-click the line button  in the toolbar; move the mouse in the screen editing window, and it will become a cross; click on the mouse in the view (i.e. screen), then a line is added.

After the above steps, the transparency of the line, the line type, width, color, the arrow and shape of end will be set by default while engineers can modify these properties in order to meet the needs of projects. Double click over a straight line, or click on the Property button  in the toolbar after selecting it. Line Property dialog box will pop up, as shown in Figure 4-24:

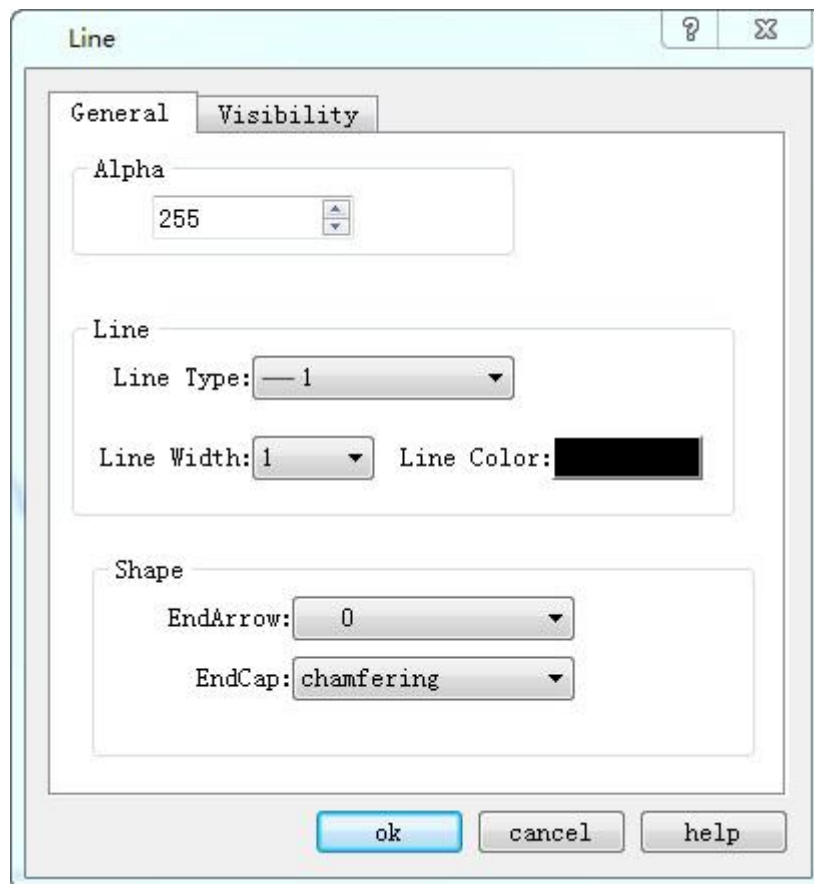



Figure 4-24 Line Property dialog box

SKTOOL configuration software provides up to 6 straight line types, 30 kinds of line width, and 6 straight-line end arrows, with the ability to adjust the properties using the pull-down and trimming buttons. To change the length, direction, and position of the line, select the line first, then move the mouse to the end of the line; after that hold the left button of the mouse, and drag the mouse to the right position to release the left button.

### 6.3.2 Polyline

Select the Polyline command in the Draw menu or click the Polyline command button  in the toolbar to move the mouse to the Edit window. The mouse will change to a cross. That's when you can draw a polyline in the Edit window.

Move the mouse to a position where you want to draw the polyline. Click the left mouse button once, then a small green dot appears in the screen editing window, which is an endpoint of the polyline.

Move the mouse to other positions in the screen, the system will automatically draw a straight line; move the mouse to change the direction; left click once and the place where you click will appear a small green box. Here the line from the first endpoint to the first small green rectangle will not move with the mouse. The mouse can be moved to the next point to change the direction of the polyline, just click the left mouse button. When you need to complete the drawing of the polyline. Lastly right click to complete drawing the polyline, as shown in Figure 4-25:

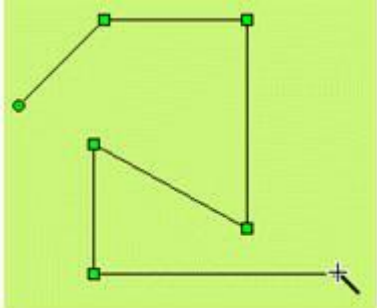



Figure 4-25 Polyline Operation

After finishing the above steps, the transparency, line type, line width, line color, end arrow and end point shape of the polyline will be set by default. The engineer can modify these attributes to meet the needs of the project. Move the cursor to the polyline; double-click the left button, or first select the line, and then click the toolbar property button , a dialog box same as that of Line Property will pop up.



You can adjust the properties of the polyline using the pull-down and fine-tune buttons. The SKTOOL configuration software provides up to 6 straight line types, 30 kinds of line width, and 6 types of end arrow for polylines. To change the length, direction and position, select the line first, and then move the mouse to the polyline; hold down the left button of the mouse, after, drag the mouse to the appropriate location to release the left button.

### 6.3.3 Curve / Arc

Select the Curve / Arc command in the Draw menu or click the Curve / Arc command button  in the toolbar menu; move the mouse to the Edit window, then the mouse cursor will change to a cross, by now you can draw a curve / arc in the Edit Window.

Move the mouse to a position where you want to curve. Left click and a small green dot appears in the window. This position is the start position of the curve / arc.

Move the mouse to other position in the screen, then the system will automatically draw a straight line; after click the left mouse button and release.

At this time, the mouse cursor is still cross-shaped. Move the mouse to other position in the screen, which is the end of the curve / arc. Hold down the left button does and move the mouse in the screen to draw the arc; release the mouse and right click to end the operation. As shown in Figure 4-26:

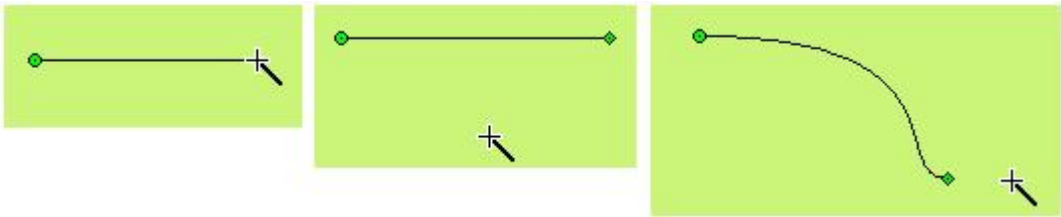



Figure4-26 Curve Operation

As shown above, the starting point of the graph is a green dot, and the end point is a diamond dot, here the initial curve / arc has been drawn. Move the mouse to the point and the cursor becomes the shape of ; hold down the left mouse button, move the mouse to the appropriate location, and then release the mouse to draw the required curve. You can also move the start or end point to the appropriate position. As shown in Figure 4-27:

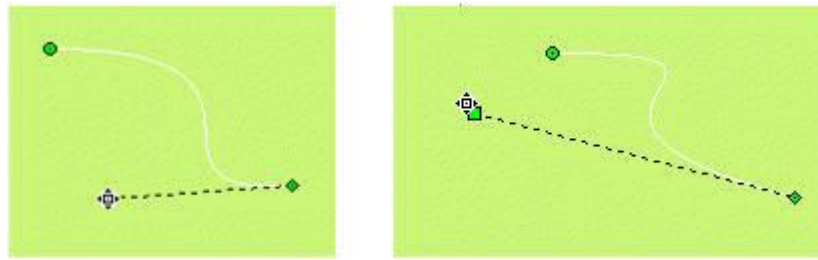



Figure4-27 Curve Operation

After completing the above steps, the transparency, line type, line width, line color, end point and endpoint shape of the curve / arc will be set by the system default. The engineer can modify these attributes to meet the requirement of engineering. Move the mouse to the curve / arc; double-click the left button, or select the curve / arc first, and then click the toolbar property button  , a dialog box same as that of Line Property will pop up.

You can adjust the curve / arc properties through the pull-down and trimming buttons. The SKTOOL configuration software provides up to 15 line types, 10 kinds of line widths, and 6 straight-line end arrows for curves / arcs.

### 6.3.4 Free Line

Select the Free Line command in the Draw menu or click the Free Line command button  in the toolbar. Move the mouse to the Edit window and the cursor will change to a cross shape so now you can draw a free line in the Edit window.

Move the mouse to a position where you want to free line; click the left mouse button, and a small green dot will appear in the editing window, which is the starting position of the free line.

Move the mouse to other positions in the screen, and then the system will automatically draw a free line following the trajectory of the mouse movement; click the left mouse button or right button to complete drawing the free line. As shown in Figure 4-28:

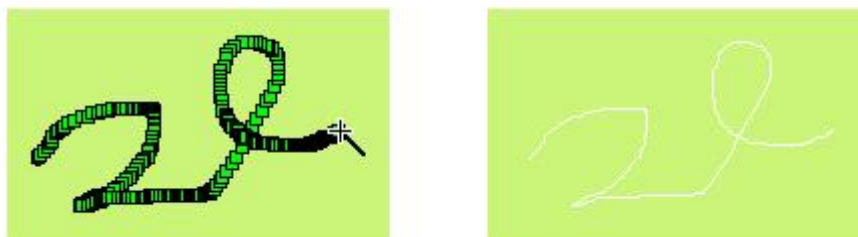



Figure4-28 Free Line Operation



After the above steps, the transparency, line type, line width, line color, end arrow and end point shape of the free curve will be set by the system default. The engineer can modify these attributes to meet the needs of the project: Move the cursor to the free curve, double-click the left button; or select the free curve first, and then click the toolbar property button , a dialog box same as that of Line Property will pop up.



In this case, you can adjust the properties of the free curve through the pull-down and fine-tune buttons. The SKTOOL configuration software provides up to 6 straight line types, 30 kinds of line width and 6 types of straight-line end arrows for curves / arcs.

### 6.3.5 Rectangle

---

Select the Rectangle command in the Draw menu or click the Rectangle command button  in the toolbar button. Move the mouse to the Edit window and then the cursor will change to a cross; click on the screen to add a rectangle.

To change the size of the rectangle, select the rectangle first, and then move the mouse to the eight square green dots which appear in the rectangle. When the mouse cursor becomes  or  or , click and hold down the left mouse button to drag the rectangle; release the left mouse button when it reaches the appropriate location. By now a required rectangular box is drawn.

-  : Change the width of the rectangle
-  : Change the height of the rectangle
-  : Change the width and height of the rectangle

After the above steps, the transparency, line type, line width, line color and fill pattern of the rectangle will be set by the system default. The engineer can modify these properties to meet the needs of the project. Move the mouse to the rectangle, double click the left button; or select the rectangle first, and then click the Property button  in the toolbar. The properties of the rectangle will pop up, as shown in Figure 4-29:

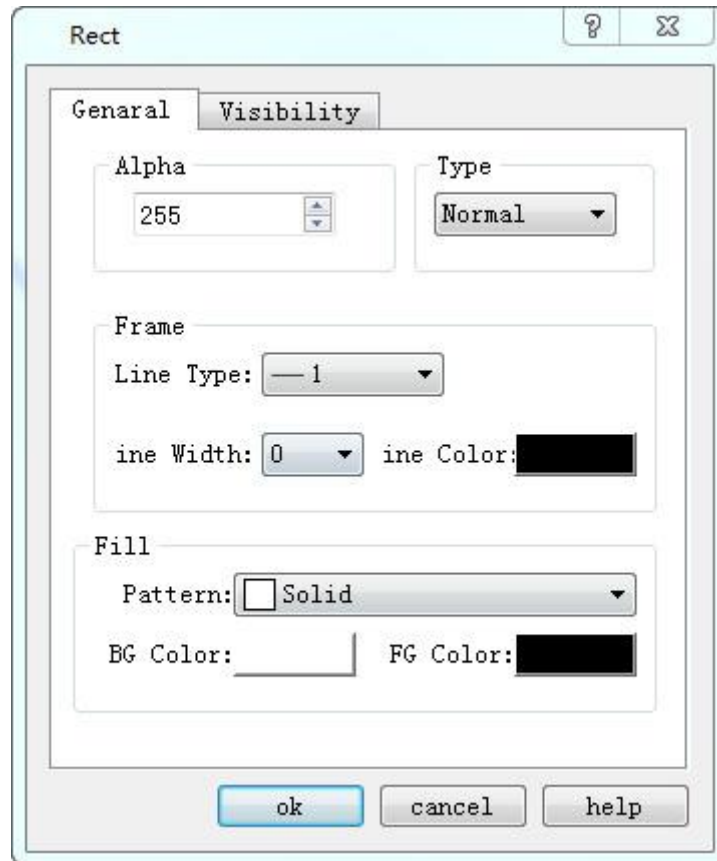

Figure 4-29 Rectangle properties dialog

You can adjust the properties of the rectangle through the pull-down and fine-tune buttons. SKTOOL configuration software provides up to 15 types of borderline, 10 kinds of borderline width and 21 kinds of fill patterns. As shown in Figure 4-30:

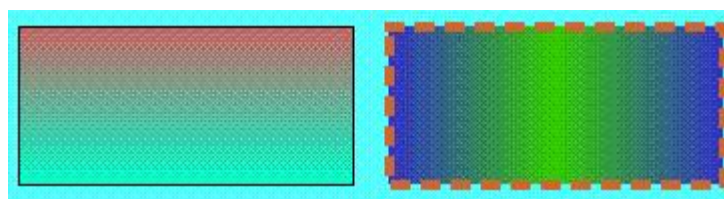





Figure 4-30 An example of a rectangle drawn



### 6.3.6 Rounded Rectangle

Choose the  icon from Basic Graphs in the control bar, move the cursor to editing area, and the cursor will become a cross.

Click the starting position where the graph will be placed, drag the cursor when pressing the mouse key. At this moment the system will automatically draw an area along the track of the cursor. Then, click left or right mouse key to complete drawing of rectangle.

To change the size of the rounded rectangle, select the rectangle first, and then move the mouse to the eight

square green dots which appear in the rectangle. When the mouse cursor becomes  or  or , click and hold down the left mouse button to drag the rounded rectangle; release the left mouse button when it reaches the appropriate location. By now a required rounded rectangular box is drawn.

-  : Change the width of the rounded rectangle
-  : Change the height of the rounded rectangle
-  : Change the width and height of the rounded rectangle

After the above steps, the transparency, line type, line width, line color and fill pattern of the rounded rectangle will be set by the system default. The engineer can modify these properties to meet the needs of the project. Move the mouse on it, double click the left button; or select the rounded rectangle first, and then click the Property button  in the toolbar. The properties of the rectangle will pop up, as shown in Figure 4-31

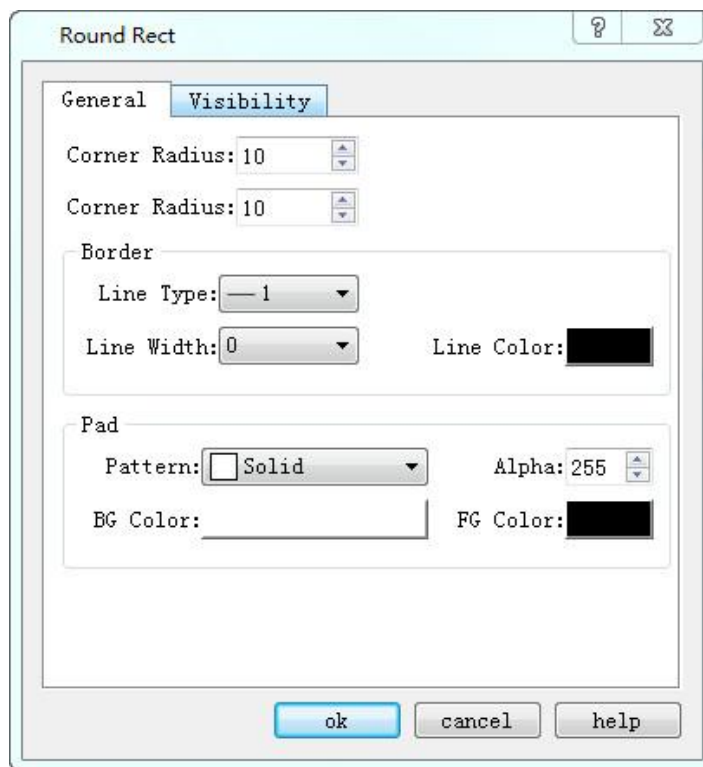









Figure 4-31 Rectangle properties dialog

Radius of X curve: Radian of the four corners in X direction.  
 Radius of Y curve: Radian of the four corners in Y direction.

### 6.3.7 Circle/Ellipse

Select the Circle/Ellipse command in the Draw menu or left-click the Circle/Ellipse command button  in the toolbar. Move the mouse to the screen editing window, and the mouse cursor will become a cross; click the left mouse button on the screen to add a circle to the screen.

To change the size of an ellipse / circle, select the Circle/Ellipse first, then move the mouse to the 8 square green dots that appear in the ellipse / circle. When the mouse cursor becomes  or  or , click and hold down the left mouse button to an appropriate location; release the left button to complete drawing.

- :Change the width of the ellipse / circle
- :Change the height of the ellipse / circle
- :Change the width and height of the ellipse / circle

After the above steps, the transparency, line type, line width, line color, and fill pattern of the ellipse / circle will be set by default. The engineer can modify these attributes to meet the needs of the project. Move the cursor to the ellipse / circle, double click the left button; or select the Circle/Ellipse first, and then click the Property button  in the toolbar, here a dialog box will pop up.

The SKTOOL configuration software provides up to 15 types of border line, 10 kinds of border line width and 21 of fill patterns for ellipse / circle. As shown in Figure 4-32:

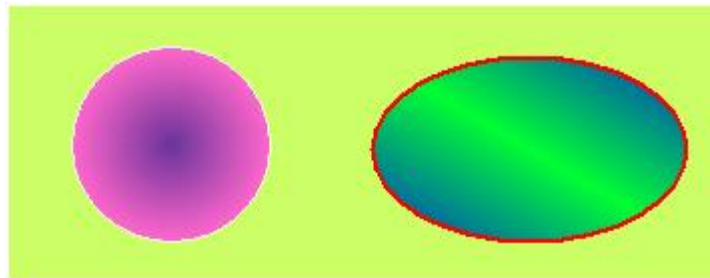



Figure4-32 Circle/Ellipse

### 6.3.8 Polygon

Select the Polygon command in the Draw menu or click the Polygon command button  in the toolbar. Move the mouse to the editing window. The mouse will change to a cross, by now you can draw a polygon in the screen.

Move the mouse to a position where you want to draw a polygon, left click (or hold down the left button), then a small green dot will appear in the screen editing window, which is the start point of the polygon.

Move the mouse to another position on the screen. At this time, the system will draw a straight line automatically. Move the mouse to other appropriate positions; each time you left click, a new side of polygon is drawn; right click to complete drawing. As shown in Figure 4-33:

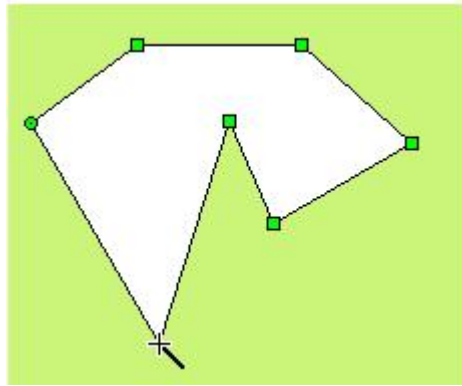



Figure 4-33 Polygon Operation

To re-shape a polygon, click it first and it will appear several green dots (depending on the number of sides of the polygon), indicating that the polygon has been selected; and then move the mouse cursor over one of them, then it will become the shape ; left click and drag it to the position you prefer, so that you can change the length and location of two lines connected by this turning point. Release the left button to complete.

After the above steps, the transparency, line type, line width, line color and fill pattern of the polygon will be set by the system default. The engineer can modify these attributes to meet the needs of the project. Move the mouse over the polygon, double click the left mouse button; or select the polygon first, and then click the Property button  in the toolbar, and a dialog box same as that of the rectangle will pop up.

You can adjust the properties of polygon through the pull-down and fine-tuning buttons. SKTOOL configuration software provides up to 15 types of border line, 10 kinds of border line width and 21 kinds of fill patterns for the polygon. As shown in Figure 4-34:

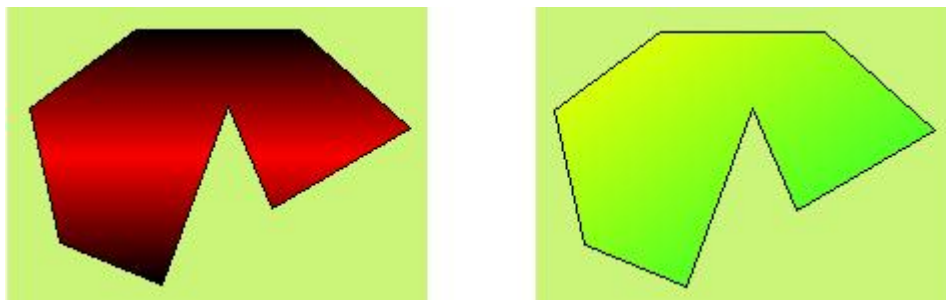



Figure 4-34 Polygon

### 6.3.9 Sector

Select the Sector command in the Draw menu or left-click the Sector command button  in the toolbar; move the mouse to the screen editing window, and then it will become a cross, which means you can draw a pie chart in the screen now. As shown in Figure 4-35:

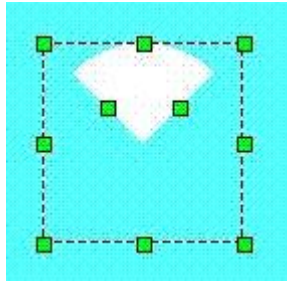



Figure 4-35 Sector Operation

Move the mouse to any point of the green dots in the middle of the rectangle, then the mouse will change to the shape ; change the arc of the sector by moving the mouse.

### 6.3.10 Text

Select the Text command in the Draw menu or left-click the Text command button  in the toolbar to bring up the Static Text dialog box, as shown in Figure 4-36:

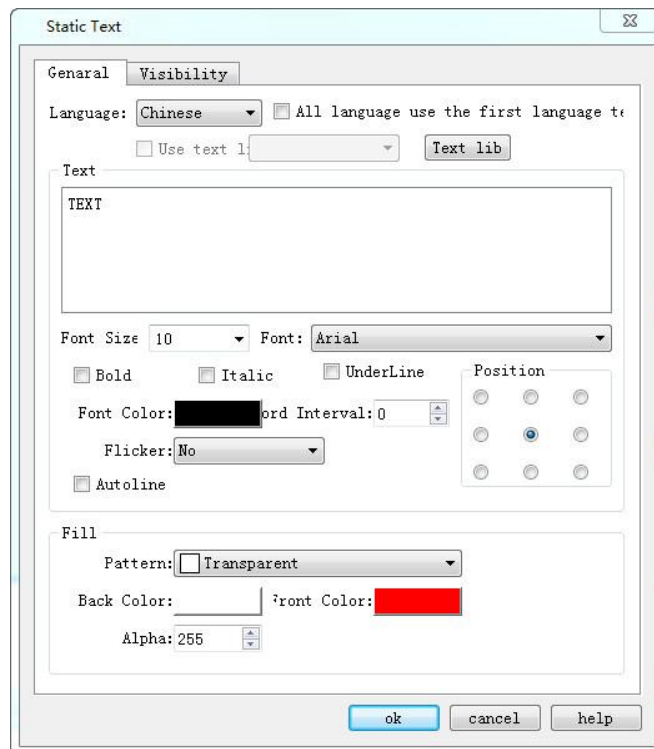





Figure 4-36 Static Text dialog box

- Input the text to be displayed in TEXT in the dialog box above.





- The size of the font to be displayed can be changed in the drop-down menu of Font Size. SKTOOL configuration software provides the font size of 7-56 pound.
- Engineering designers can change the types of fonts to be displayed in the drop-down menu of Font. SKTOOL configuration software provides almost all font styles.
- Language: For different languages, you can enter different text contents in the text box, different font and font size are also available..
- In the dialog box, click the left button before the Bold and Italic box to change the fond.
- The configuration software provides kerning and line spacing that vary from 0-15 through the fine-tuning button next to the kerning and line spacing
- SKTOOL configuration software also provides up to 16 kinds of underline form, and can change the display position of text contents in the text box; you can also change the fill pattern and transparency.

#### **Text renderings**

- When the font property is modified, click OK to close the dialog box. Move the mouse to where you want to place the text in the editing window; left click the left mouse button, and the system will draw a rectangle automatically.
- To modify or re-input the text contents, double-click the text unit with the left mouse button, then re-enter the contents through the keyboard. You can use the Enter to change line feed when using the keyboard.
- To change the size of the text background box, select the text unit, and then move the mouse to its edge; when the mouse becomes  or  or , click and hold down the left mouse button to pull the text box to the appropriate location; after that release the left mouse button to complete the operation.

 Change the width of the text unit background

 Change the height of the text unit background

 Change the width and height of the text unit

### **6.3.11 Table**

---

Select the Table command in the Draw menu or the left click the command button  in the toolbar, then it will appear a pop-up table dialog box, as shown in Figure 4-39:

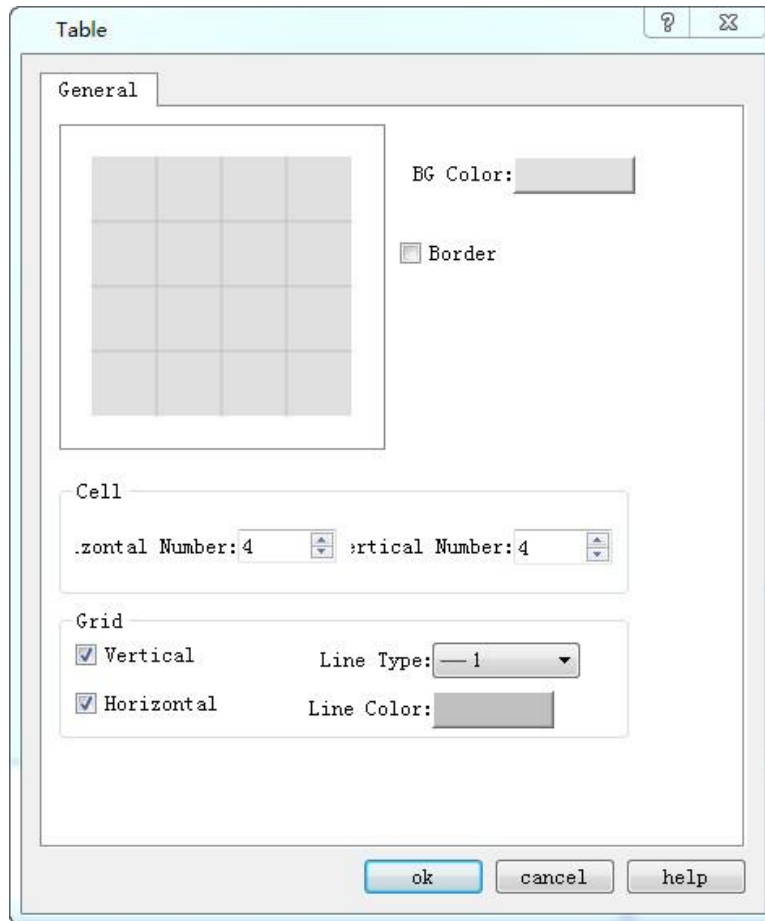



Figure 4-39 table dialog box

In the above dialog box of the above diagram, SKTOOL configuration software provides choices of the Background Color, Border, Grid and Grid lines. You can decide whether to display vertical or horizontal grid lines in the Grid option, and the type and color of lines are changeable.



The table is just a graphic object, which means you cannot add text, data or other embedded objects to the table. The table can only be displayed as a chassis image. To display text, data, and other objects on a table, you can use Text and numeric display objects to overlay the table and set it to the top layer.

### 6.3.12 Scale

Select the Table command in the Draw menu or the left click mouse the command button  in the toolbar, then it will appear a pop-up scale dialog box, as shown in Figure 4-41:

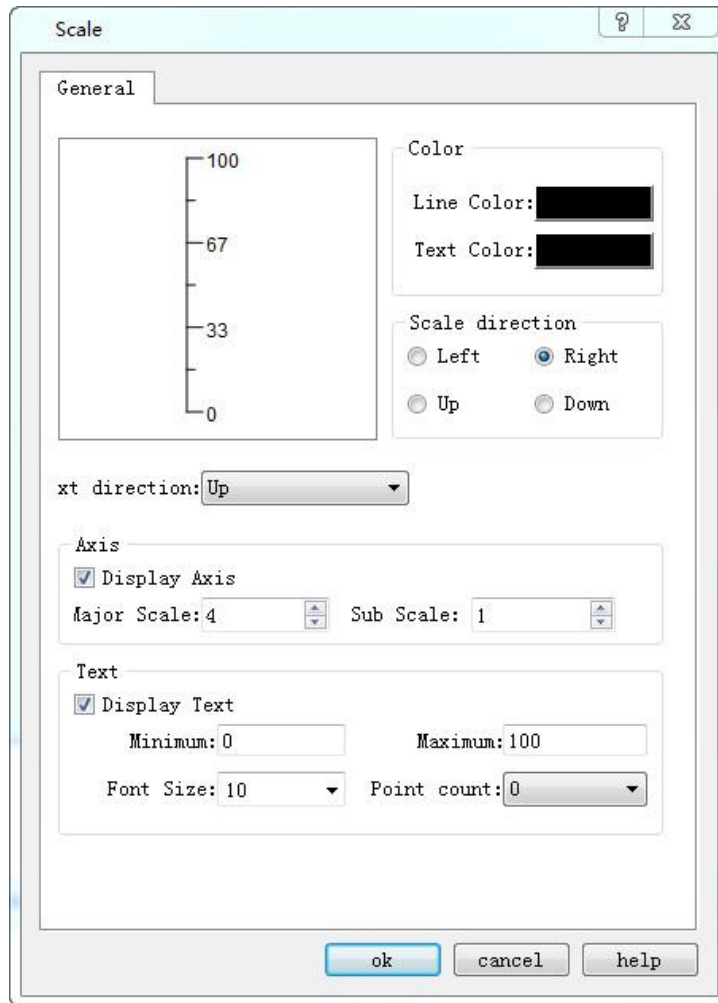

Figure 4-41 Scale Dialog Box

In the above dialog box, SKTOOL configuration software provides choices of Color, Axis and Text. The color item allows to selecting the line color and text color. You can select whether to display the axes in the Axis item and decide the number of the major scale and sub scale by means of the trimming button or inputting directly. Decide whether to display text in the text item and change the maximum and minimum values of the scale, as well as the size of the text and the decimal digits of the scale value.

When you have modified the scale property and click OK to close the dialog box, move the mouse to the position where you want to display the scale. Click the left mouse button, and then the system will automatically draw a scale unit. As shown in Figure 4-42:

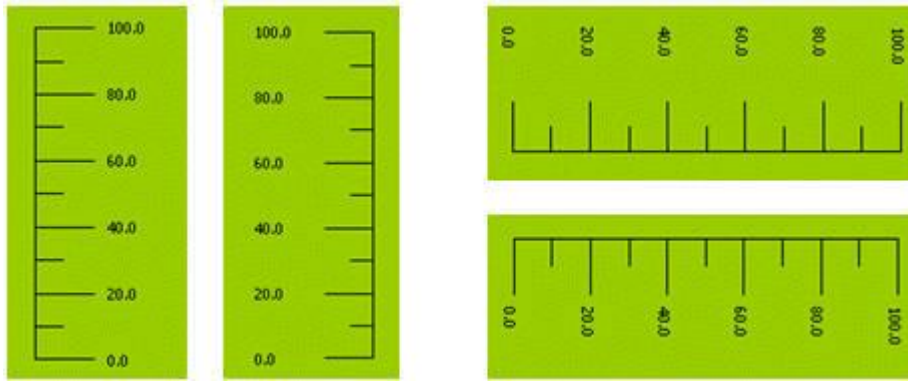



Figure 4-42 Scale effect diagram

After the above steps, a scale like first from left of the figure above. If you want to change it to the form of the second left scale in the figure above, first choose the scale, move the mouse to one of the height sides, press down the left key and drag the mouse when the mouse becomes , and have the mouse pass through the other height side. To change the scale to the right forms in the figure above, perform Free Rotation for it.

### 6.3.13 Open Library

Select the Open Library command in the Draw menu or click the Open Library command button  in the toolbar to bring up the Library List dialog box, as shown in Figure 4-43:

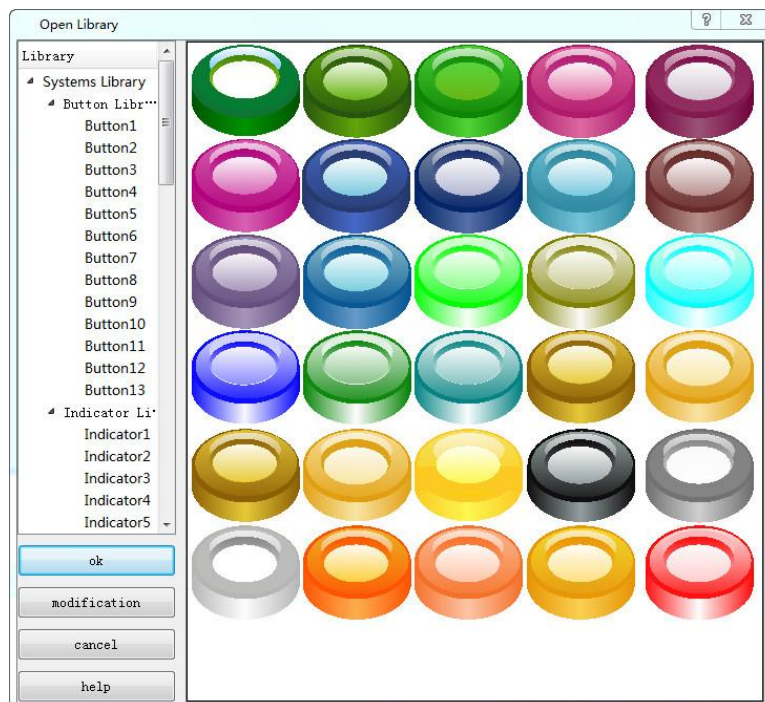

Figure 4-43 Library List

The system library of SKTOOL configuration editing software provides a wealth of graphic objects for

engineering designers. SKTOOL version is even added a large number of buttons, indicators and other graphic objects. Engineering designers can find a proper graphic object so as to save configuration design time.

Engineers only need to click on the category of the desired graphic object in the system library on the left. Click the + sign to open the sub-category, and then select the desired graphic. Click to select the image, and then click on the screen to add graphic object when the cursor become a cross.

Modify: After selecting the graphic you want to modify, click the "Modify" button at the bottom left of the dialog box, as shown in Figure 4-44:

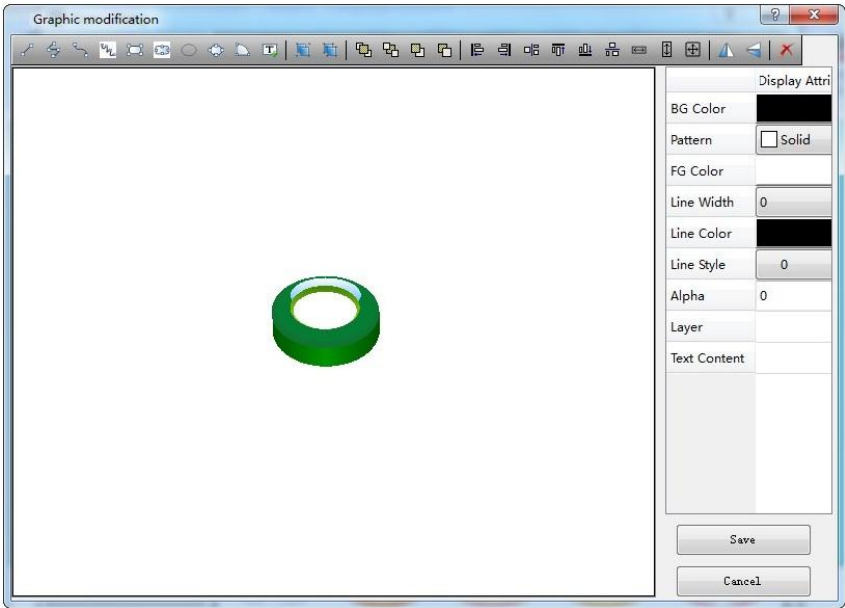

Figure 4-44 Library Modify Dialog Box

In the interface shown as Figure 4-44, select the graphic, and then execute the "Split" function on the tool bar to split the control. Then you can choose one part to modify: settings of foreground color, background color, pattern and others can be found on the right of the dialog box. After modification, execute the Group command to the entire split graphics, and then click the "Save".

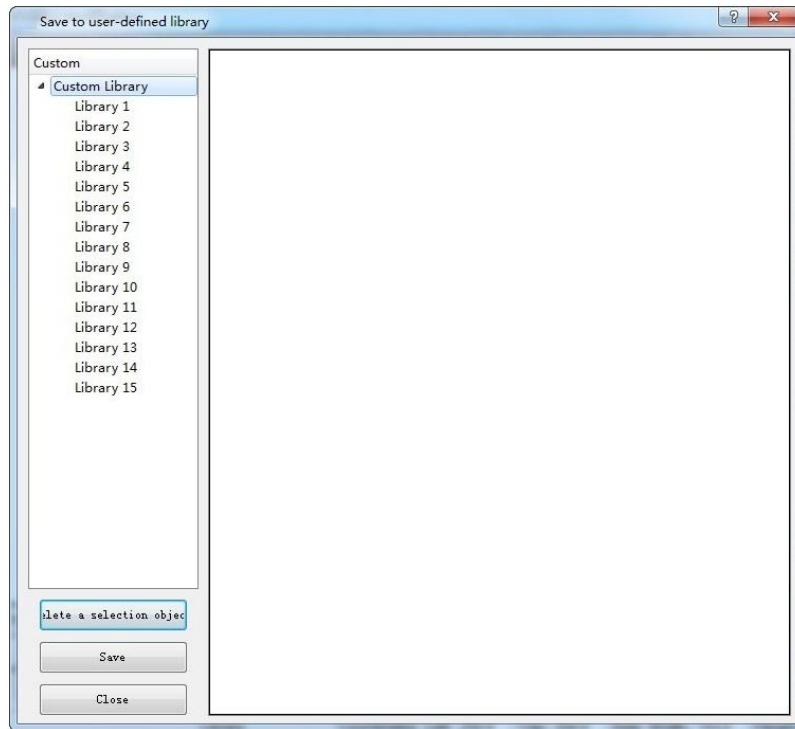



Figure 4-45 dialog box is displayed

In the "Custom" list on the left of the dialog box, select the location where you want to save the modified graphics (e.g. "Library 2") and click "Save". If you want to view the newly saved graphics, click the Open Lib command button  in the pop-up dialog box, then select the "Custom Library".

### 6.3.14 Extern Picture

---

In SKTOOL, pictures can be inserted into a number of controls; take the Static Picture as an example:

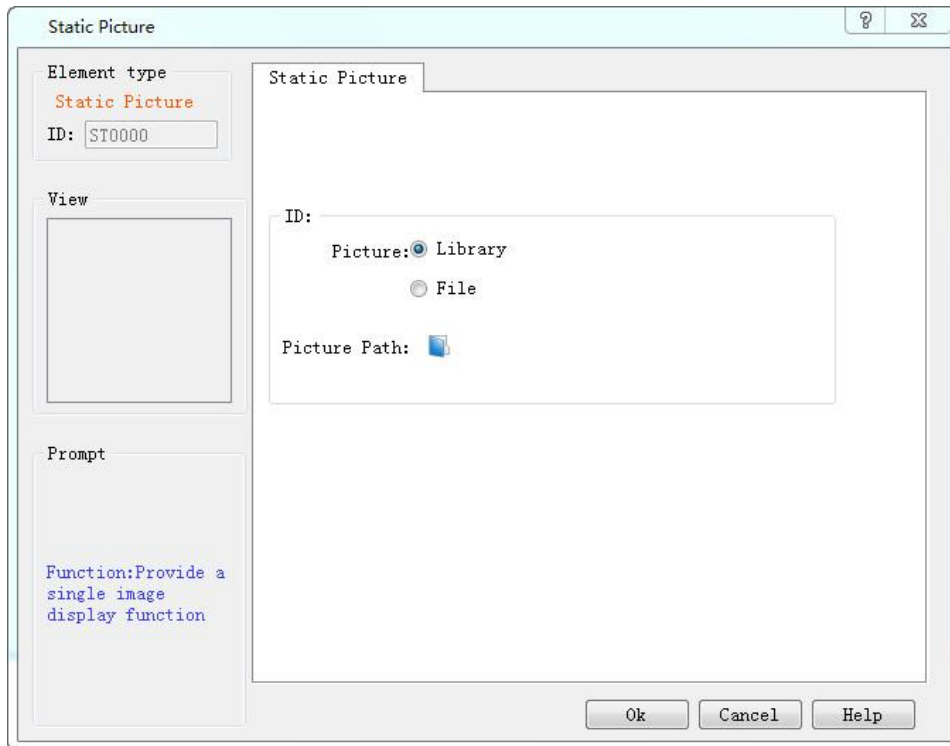

Picture:  
Library: Built-in gallery in the system, as shown below:

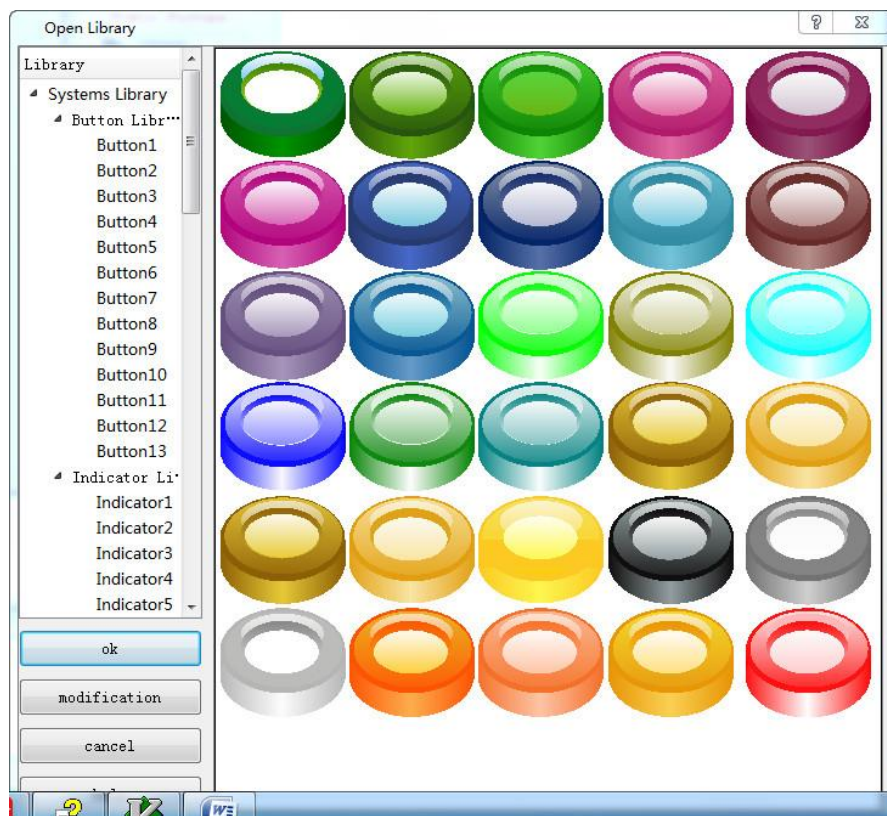

File: Consist of External File and System File. External pictures can be those in computer and system pictures are available for downloading on the official website, which will be saved in the folder of Extern\_Pic under the installation directory.

When "System" is selected, the following dialog box will pop up:



These images are stored in the Extern\_Pic folder under the installation directory, as shown below:

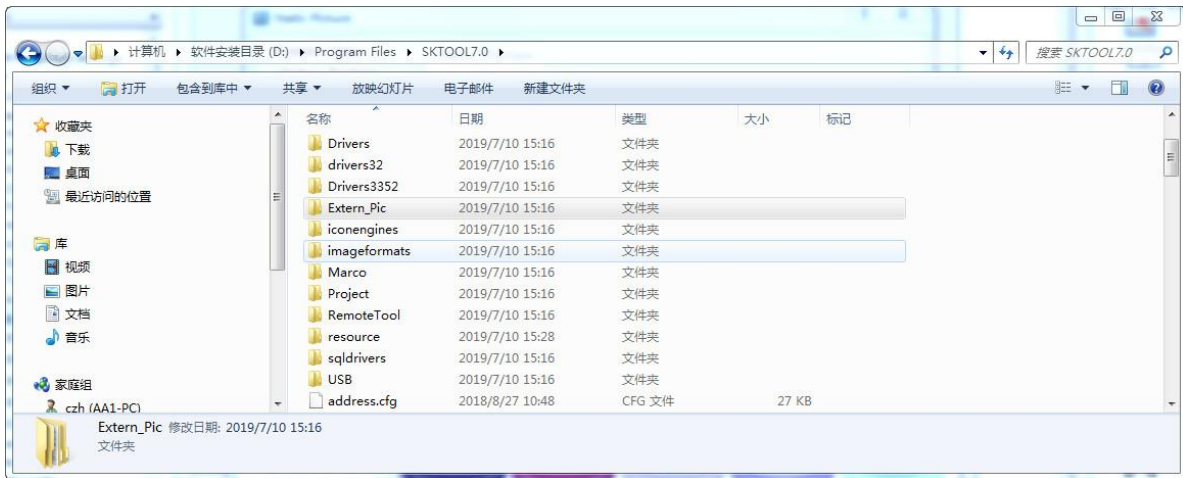

The Extern\_Pic folder contains two folders: the share\_picture folder and system\_picture folder, corresponding respectively to the shared picture and system picture in the Gallery image list, of which those in the system\_picture folder are system pictures that cannot be added or modified. While those in the share\_picture folder can, as shown in the following figure:



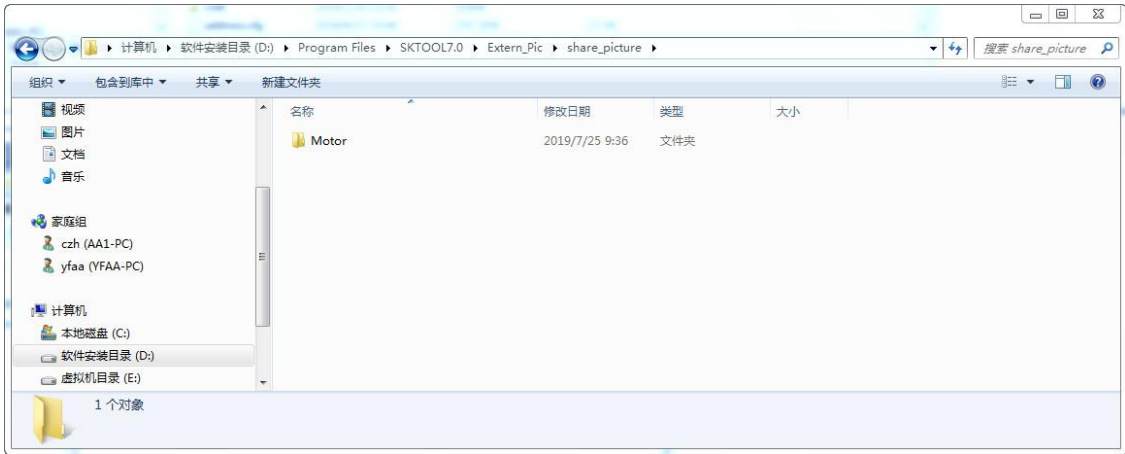

You can add other folders by yourself in the share\_picture folder or change the name of an existing folder (for example, Motor), meanwhile the name of share\_picture folder cannot be changed. In addition, it is possible to add or delete pictures of the Motor folder.



The compressed file of share\_picture.rar is available for downloading on the official website; unzip it into PC after downloading; follow the above method to add it into the share\_picture folder, and then it is also available in the [Gallery image list](#).

### 6.3.15 Regular polygon



Select the straight line command in the drawing menu or the left mouse button to click the regular polygon



command button in the toolbox button to set the number of corners, transparency, line type, line width, line color of the regular polygon. To meet the needs of the project. After setting, click the button to

determine the button, the screen appears cross mark, move to the appropriate position of the screen, click the left, you can draw a regular polygon. You can click the right polygon control through the left mouse button,

right-click the "property" or click the toolbar button , set the property, modify the regular polygon.

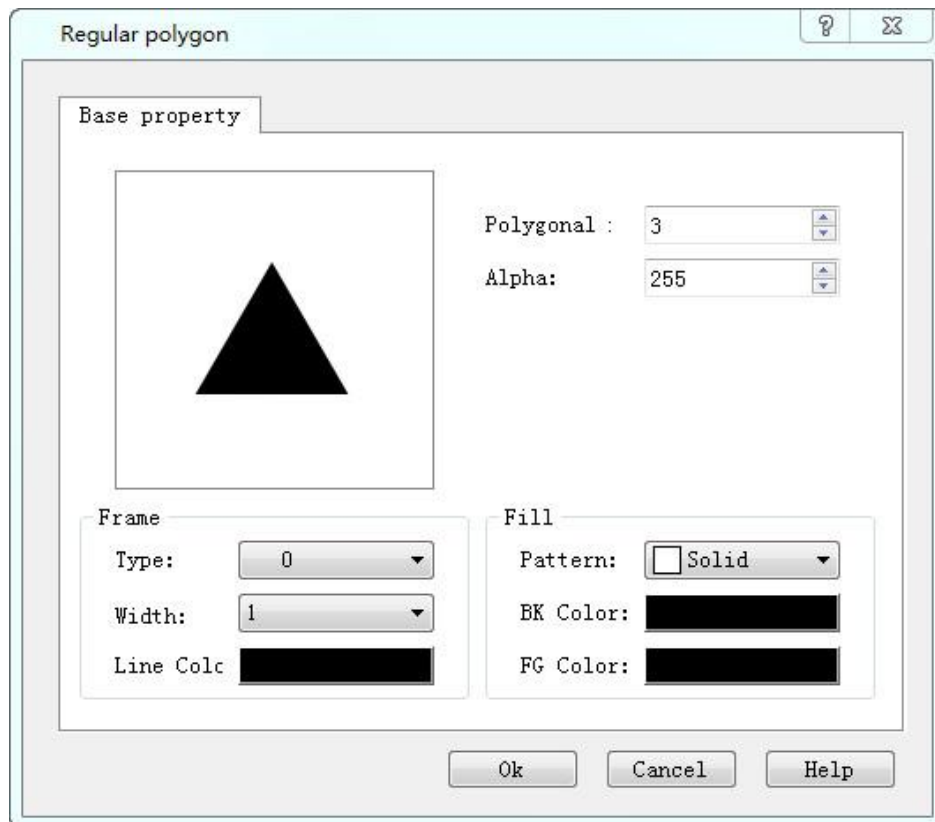
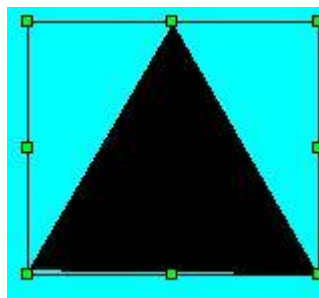

Figure 4-24 Line Property dialog box



The size of the control can be freely stretched by controlling the green dots around it.

## 6.4 SKTOOL Advanced controls

This chapter introduces the advanced controls.

### Contents:

- [GIF Display](#)
- [Trend Chart](#)
- [XY Trend Chart](#)

- [Dynamic Circle](#)
- [Dynamic Rectangle](#)
- [Alarm Display](#)
- [Alarm Bar](#)
- [Historical Alarm Display](#)
- [Graphics Move](#)
- [Meter](#)
- [Historical Data Display](#)
- [Message Display](#)
- [Flowing block](#)
- [Timers](#)
- [Multi-function keys](#)
- [Pie show](#)

### 6.4.1 GIF Display

---

GIF display can be used to display images of GIF format, supporting 32 frames at most. Operation is as follows:

Click the GIF icon  on the toolbar to display the dialog box shown in Figure 4-48.

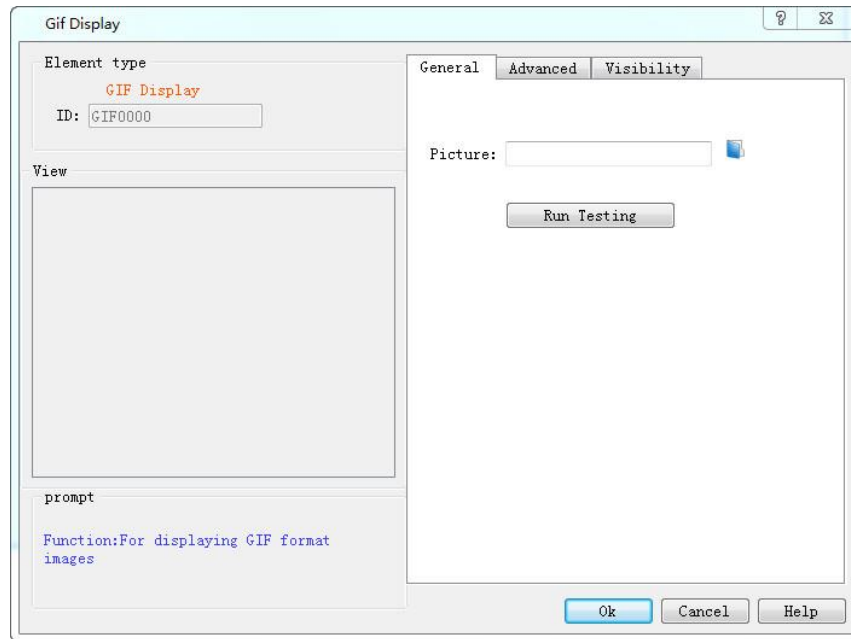

Figure 4-48 GIF Display dialog box

After setting the properties, click "OK", then the mouse cursor will become a cross in the editing area; left click to draw a rectangle and the control is added to the view area (i.e. the screen)

Select the "Advanced" page to display its properties.

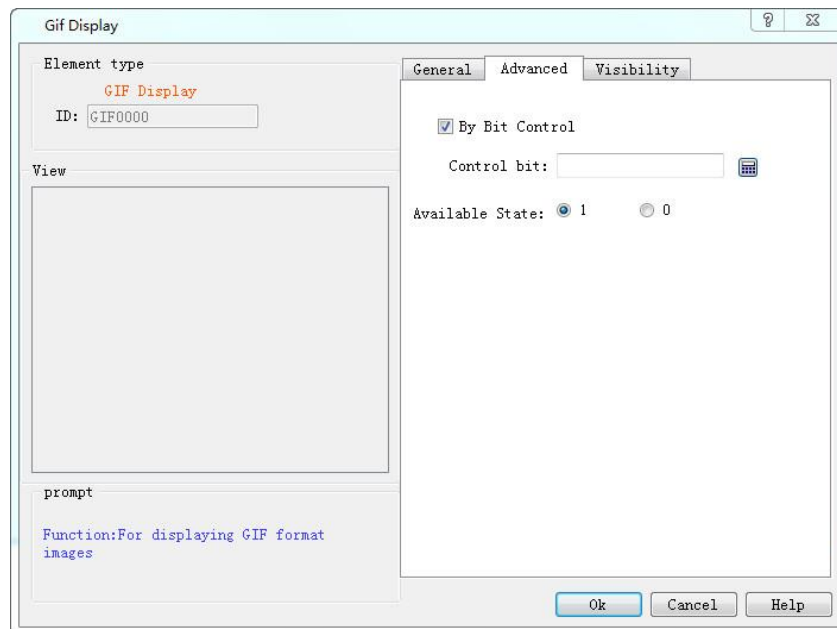

Figure 4-49 GIF Display "Advanced" page

Controlled By bit: When "Controlled by Bit" is selected, if the "Active Status" selected is 1, the GIF picture will be animated if and only if the value of "Control bit" is 1, otherwise it is a static display; when the selected "Active Status" is 0, the GIF picture will be animated if and only if the value of "Control Bit" is 0, otherwise it will be displayed statically.



The "Visibility" page can refer to the use of "Bit Button" control.

## 6.4.2 Trend Chart

---

### Trend Chart Summary:

Dynamic, variable and continuous value displayed continuously.

Draw reference curves of multiple data. Take the time as the horizontal axis, the value as the vertical coordinate axis, in order to accurately and intuitively judge the change tendency of a certain value during a period of time.

Up to 8 polylines can be displayed (line graph).

Add properties of the trend graph:

1. Select the Trend Chart icon  in the toolbar, and then the properties dialog box appears, as shown in Figure 4-50

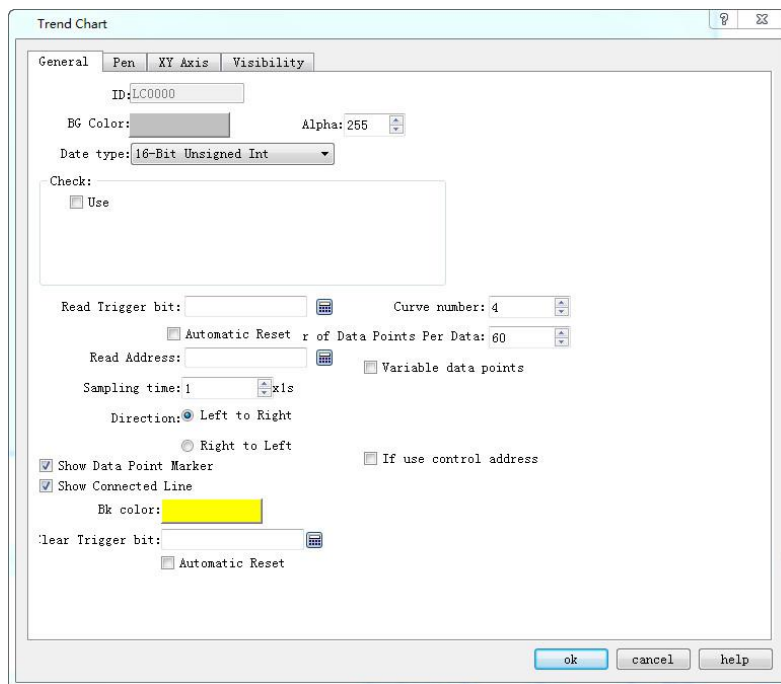

Figure 4-50 Trend Chart Common Dialog Box

- Background color: Change the background color of the trend chart. The effect cannot be visible until you click OK.
- Data type: 7 kinds of data types are available for users.
- Read trigger bit: Only when the "Read trigger bit address" value is 1, the curve will move around.
- Curve number: Number of lines, up to 8.
- Automatic reset of Read trigger bit: When the read address detected is 1, then the address value is assigned to 0.
- Number of data points per group: Number of data shown on the X-axis.
- Sampling time: The sampling frequency.
- Read Address: The value of the Read Address represents the value of each line on the Y-axis direction. According to different data group numbers and data types, Read address can be read continuously (16-bit data) or read at intervals (32-bit data).
- Variable data points: According to the address value of the dynamic set of "Number of data points per group." When this option is selected, the address value default is the initial value of the Number of Data Points per Group.

#### Detection

- Enabled: Indicate whether the detection line (reference line) is enabled.
- Color: The color of the detection line (reference line).
- Detection address: Write the value of the current detection line (reference line) to the detection address.
- Whether to use the control address: Set the dynamic minimum and maximum value of the Y-axis according to the value of control address value. This address occupies five consecutive address shifts; change the minimum and maximum value of the Y-axis scale referencing the X-axis and also whether to restore the initial state.

| Address Offset | Control Register Address Control object  |
|----------------|--|
| 0              | 16 bits less than the minimum value  |
| 1              | 16 bits more than the minimum value  |
| 2              | 16 bits less than the maximum value  |
| 3              | 16 bits more than the maximum value  |
| 4              | Whether to restore the initial state of the maximum and minimum values. The address value of 1 indicates a dynamic change, otherwise the initial value is restored |



The control address can only use the internal address, and the minimum and maximum value account for two

---

consecutive word address respectively.

E.g.:

When the 16-bit data type is selected and the number of data groups is 8, it is assumed that the user-input address is LW3, and 8 groups of address values are continuously read out,

LW3: The value of line 1

LW4: The value of line 2

LW5: The value of line 3

LW6: The value of line 4

LW7: The value of line 5

LW8: The value of line 6

LW9: The value of line 7

LW10: The value of line 8

Therefore, when the user selects 16-bit data and sets the number of N groups of data, the user can read out the address values of the N groups in succession according to the address rules of different PLC models.

When the 32-bit data type is selected and the number of data groups is 5, it is assumed that the user-input address is LW3. Then, 5 sets of address values are read out consecutively.

LW3: The value of line 1

LW5: The value of line 2

LW7: The value of pen 3

LW9: The value of line 4

LW11: The value of line 5

Therefore, when select 32-bit data and set the N-group data group number, user can read out the N group address value by adding 2 to the address value (at interval) according to the address rules of different PLC models.

➤ Direction:

- Left to right: The line moves from the left.
- Right to left: The line moves from the right.
- Background color: The color of the line
- Clear Trigger Bit: Clear the current status of all lines when the address value changes from 0 to 1 (rising edge). The line remains the same when the address value changes from 1 to 0 (falling edge) or has no change,.

The "Line" page of the Trend Chart is shown in Figure 4-51: This page allows user to set the maximum value,

minimum value, style and color of each pen.

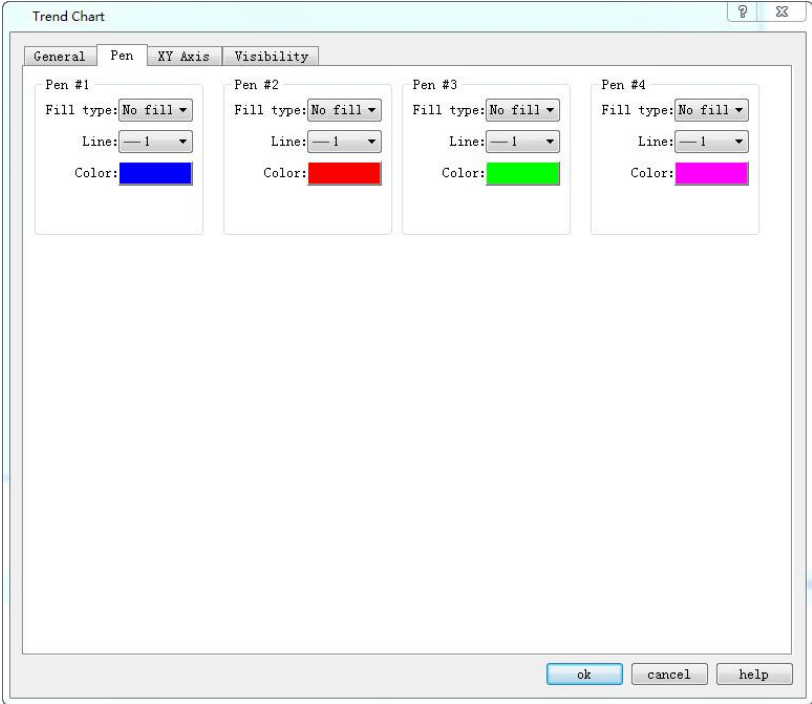

Figure 4-51 Trend Chart Pen Dialog Box

The data type in the General page determines that of the maximum and minimum values here.

For example, if the maximum or minimum value is a floating-point number, user must first select 32-bit floating-point number in the Data Type in the General page. Otherwise, an error will occur when user clicks "OK".

3. The "XY Axis" page of the trend chart is shown in Figure 4-52:



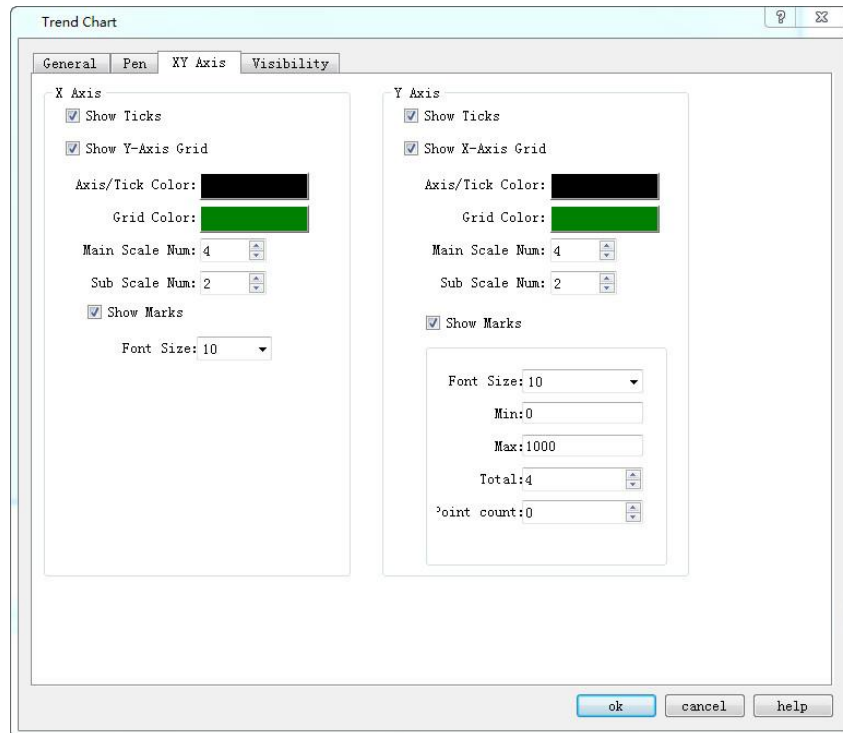

Figure 4-52 Trend Chart XY Axis Dialog Box

➤ X-axis

- Display scale: whether to display the X-axis scale.
- Show Y-axis grid: Whether to display Y-axis grid.
- Axis / Scale Color: Change the color of the X-axis / scale.
- Grid Color: Change the X-axis grid color.
- Main sub-scale: X-axis main scale.
- Sub-scale: X-axis times the number of times.

Display Scale Indicates whether the X-axis scale is displayed.

➤ Y-axis

- Display Scale: Whether to display the Y-axis scale.
- Show X-axis grid: Whether to display the X-axis grid.
- Axis / Scale Color: This option changes the color of the Y-axis / scale.
- Grid Color: This option changes the Y-axis grid color.
- Major scale division: Numbers of Y-axis major scale.
- Sub-scale division: Numbers of Y-axis sub-scale.
- Show Marks: Whether to display the Y-axis scale mark.
- Font Size: Change the font size of the Y-axis scale.
- Minimum: The minimum value of the Y-axis scale.
- Max: The maximum value of the Y-axis scale.
- Total: Display the maximum digital number of the data.

- Decimal Place: The maximum digital number that can be displayed after the decimal point.



The "Visibility" page can refer to that of "Bit Button" control.

### 6.4.3 XY Trend Chart

---

#### XY Trend Chart Overview:

Dynamic, variable and continuous value displayed continuously.

You can draw multiple data reference curve, and take two consecutive register address value as the horizontal axis and vertical axis coordinates respectively, in order to observe the change rules accurately and intuitively.

Up to 8 polylines can be displayed (line graph).

Operations of adding XY Trends and modifying XY Trend Properties are similar to those of Trend Chart. Users

can refer to the "Trend Chart" page operation. Open the icon 

Open the XY Trend Property dialog box; refer to the "Trend Chart" property settings. It should be noted that each line in the Trend Chart represents the value of consecutive addresses starting from the write address, and each in the XY Trend Chart represents the value of two consecutive addresses starting at the write address.

#### XY Trend Chart Application:

Color: The color of the detection line (reference line).

Detection address: Write the value of the current detection line (reference line) to the detection address.

For example, if 16-bit data type is selected and the number of data groups is 4, assuming that the user-input address is LW3, 8 sets of address values are continuously read,

LW3: Line1 Value of the X-axis

LW4: Line 1 Value of the Y-axis

LW5: Line 2 Value of the X-axis

LW6: Line 2 Value of the Y-axis  
LW7: Line 3 Value of the X-axis  
LW8: Line 3 Value of the Y-axis  
LW9: Line 4 Value of the X-axis  
LW10: Line 4 Value of the Y-axis

The addresses to be read are LW3-LW10, with 8 groups of addresses. Therefore, when select the 16-bit data and sets N groups of data, you can read values of  $2 * N$  groups of address consecutively according to address rules of different PLC models.

When the 32-bit data type is selected and the number of data groups is 3, assuming that the user-input address is LW3, then it needs to read address values of 12 data groups in succession.

LW3: Line 1 Value of the X-axis  
LW5: Line 1 Value of the Y-axis  
LW7: Line 2 Value of the X-axis  
LW9: Line 2 Value of the Y-axis  
LW11: Line 3 Value of the X-axis  
LW13: Pen 3 Value of the Y-axis

The addresses to be read are LW3-LW14, with 12 sets of address. Therefore, when select 32-bit data and set N groups of data, you can read address values of  $2 * N$  data by plus 2 at interval according to address rules of different PLC models.

## 6.4.4 Historical Trend Chart

---

➤ Historical Trend Chart Overview: This trend chart is used in conjunction with the "[Historical Data Collector](#)" in the Project Manager. That is, it shows the value of the data in the "Historical Data Collector".

➤ Overview of XY Trend chart:

Dynamic, continuous display of variable continuous value.

Display multiple data reference curves. Take the time as the X axis, the address nvalue as the Y axis, in order to judge the change tendency of certain address value accurately and intuitively during a period of time.

Up to 8 polylines can be displayed (line graph).

- Add the trend chart and modify its properties:



1. Select the trend icon in the toolbar, the Historical Trend Property dialog box appears, as shown in Figure 4-53:

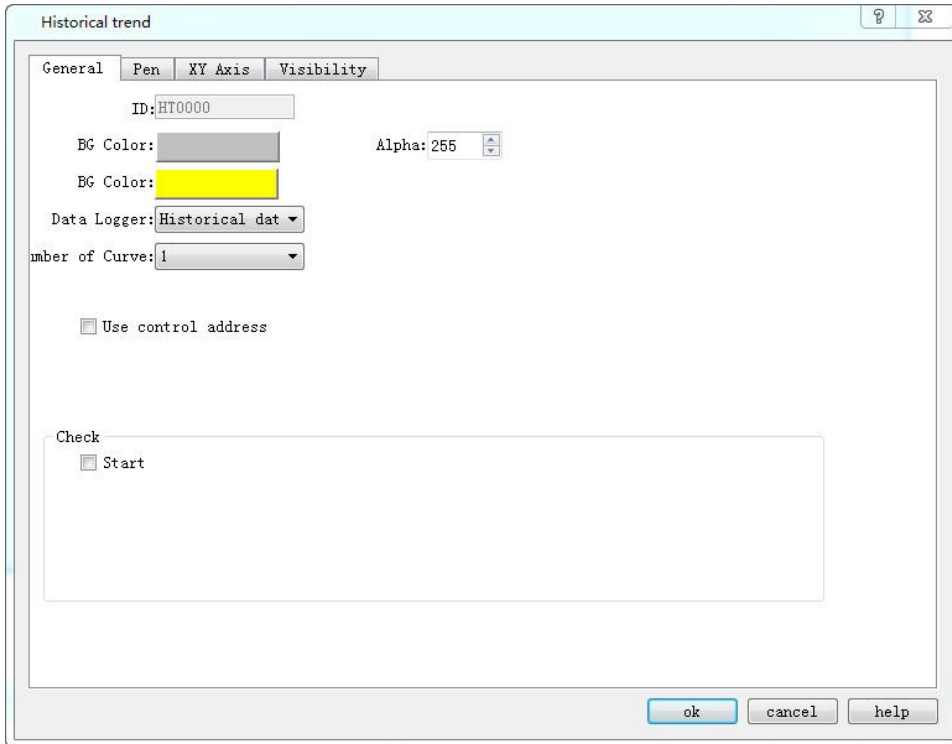
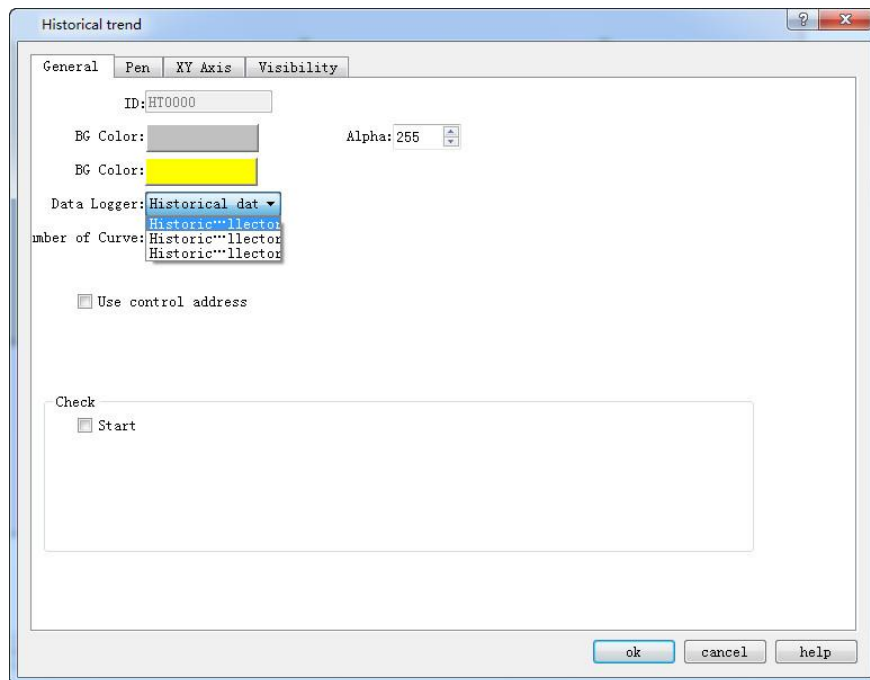

Figure 4-53 Historical Trend General page dialog box

- Background color: Change the background color of the trend chart. Change the color cannot directly see the color change, click "OK" to apply.
- Transparency: Change the transparency of the background color.
- Data Collection: The default is that from "Historical data collector " in Project Manager. SKTOOL adds multiple sets of historical data, so developers who choose this option can choose which set of historical data to use. As shown below:



- Number of curves: Number of line to be displayed; up to 8.
- Background Color: The color of the pen (or line) trace.
- Use control address: Whether to use control address. It is occupied by 28 address offset, used to control the display of each line, maximum value, minimum value, the end time of control, control time period (minutes), the maximum value when only the Y axis is displayed, the minimum value when only the Y axis is displayed whether to display the Y axis and the restoration to the initial state.

| Address offset | Controlled object by control register address |
|----------------|---|
| 0              | Set the total number of lines displayed       |
| 1              | Whether to display 1                          |
| 2              | Whether to display 2                          |
| 3              | Whether to display 3                          |
| 4              | Whether to display 4                          |
| 5              | Whether to display 5                          |
| 6              | Whether to display 6                          |
| 7              | Whether to display 7                          |
| 8              | Whether to display 8                          |
| 9              | Maximum value in Y axis                       |
| 10             |   |
| 11             | Minimum value in Y axis                       |
| 12             |   |

|    |   |
|----|---|
| 13 | When set to 0, use the default maximum and minimum value; when set to 1, set the upper and lower limits |
| 14 | Query start time  |
| 15 |   |
| 16 |   |
| 17 |   |
| 18 |   |
| 19 |   |
| 20 | Query end time  |
| 21 |   |
| 22 |   |
| 23 |   |
| 24 |   |
| 25 |   |
| 26 | When set to 1, enter the query, and return to the state 0 automatically                                 |
| 27 | When set to 1, recover to new state and return to the state 0 automatically                             |

Whether to display the control address:

**Detection**

- Enabled: Indicate whether the detection line (reference line) is enabled.
- Color: The color of the detection line (reference line).
- Detection address: Write the corresponding value to of the current detection line (reference line) to the detection address register.

2. The "Line" page of the historical trend graph is shown in Figure 4-54.

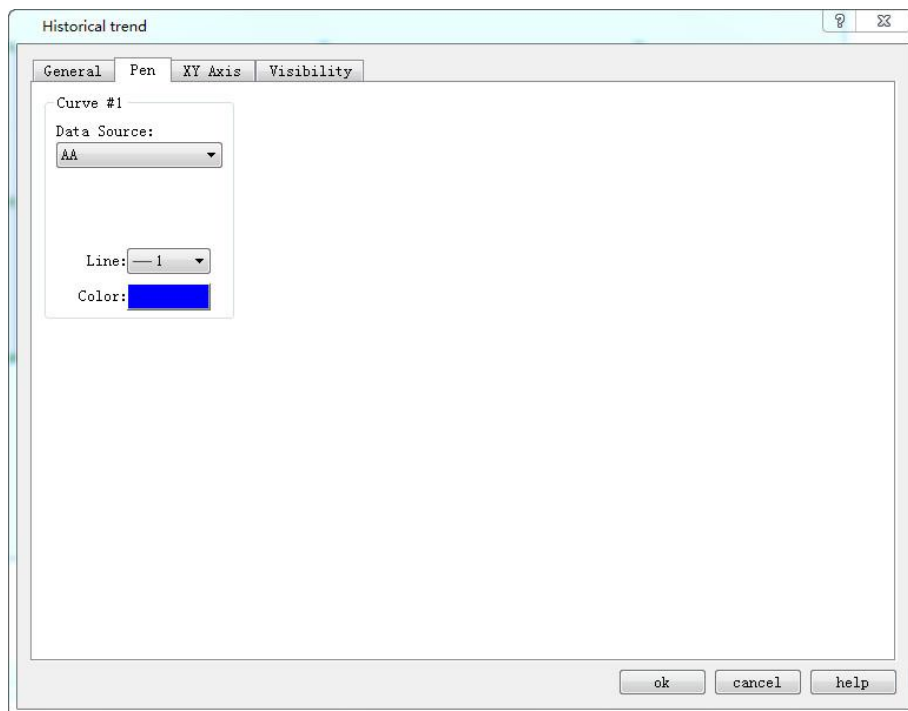

Figure 4-54 Pen tab of Historical trend

This page allows setting the maximum, minimum, pattern, and color of each line. The data source is the “[Historical Data Collector](#)” in the Project Manager. Each line can correspond to a different data source.

3. The "XY Axis" page of the historical trend chart is shown in Figure 4-55.

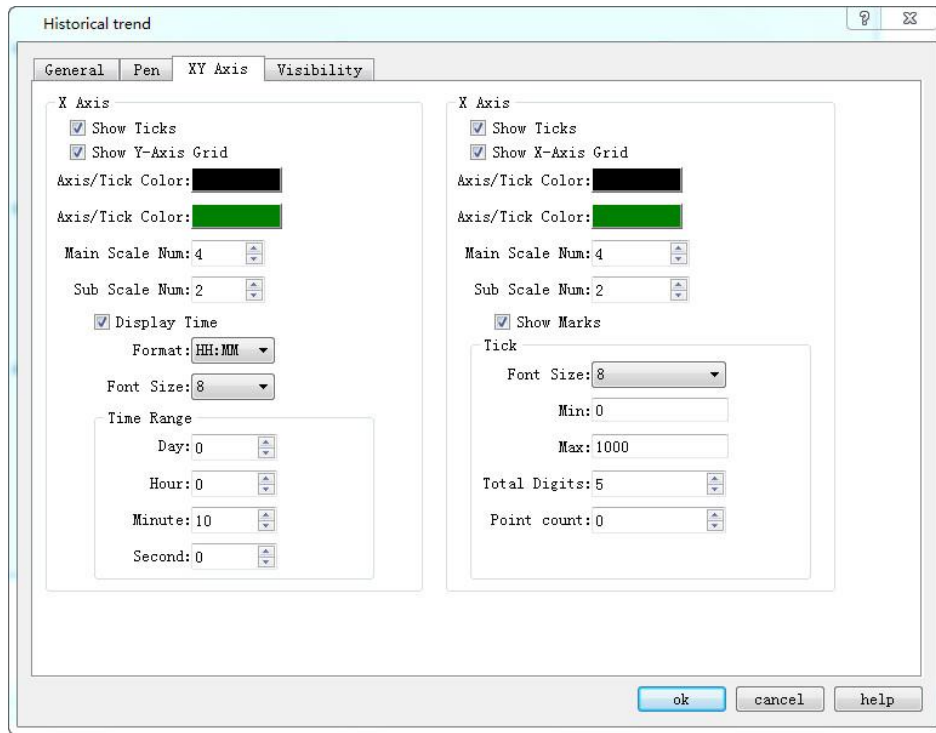

Figure 4-55 XY Axis tab of Historical Trend

#### X-axis

- Display scale: whether to display the X-axis scale.
- Show Y-axis grid: Whether to display Y-axis grid.
- Axis / Scale Color: Change the color of the X-axis / scale.
- Grid Color: Change the X-axis grid color.
- Main sub-scale: X-axis main scale.
- Sub-scale: X-axis times the number of times.
- Display time: Set the time format and font size of time.
- Time Range: Set the time range displayed on the trend graph.

#### Y-axis

- Display Scale: Whether to display the Y-axis scale.
- Show X-axis grid: Whether to display the X-axis grid.
- Axis / Scale Color: This option changes the color of the Y-axis / scale.
- Grid Color: This option changes the Y-axis grid color.
- Major scale division: Numbers of Y-axis major scale.
- Sub-scale division: Numbers of Y-axis sub-scale.
- Show Marks: Whether to display the Y-axis scale mark.
- Font Size: Change the font size of the Y-axis scale.
- Minimum: The minimum value of the Y-axis scale.
- Max: The maximum value of the Y-axis scale.
- Total: Display the maximum digital number of the data.
- Decimal Place: The maximum digital number that can be displayed after the decimal point.
- Display the multi-axis: whether to display multiple axes.



The "Visibility" page can refer to that of "Bit Button" control.

## 6.4.5 Dynamic Circle

A dynamic circle is designed to move and change size following certain track by placing a graphic on the screen. This movement and size change are determined by the value of the monitor address. Add the dynamic graphic control and modify the dynamic graphic control properties:

Select the dynamic circle icon  in the toolbar, as shown in Figure 4-56:

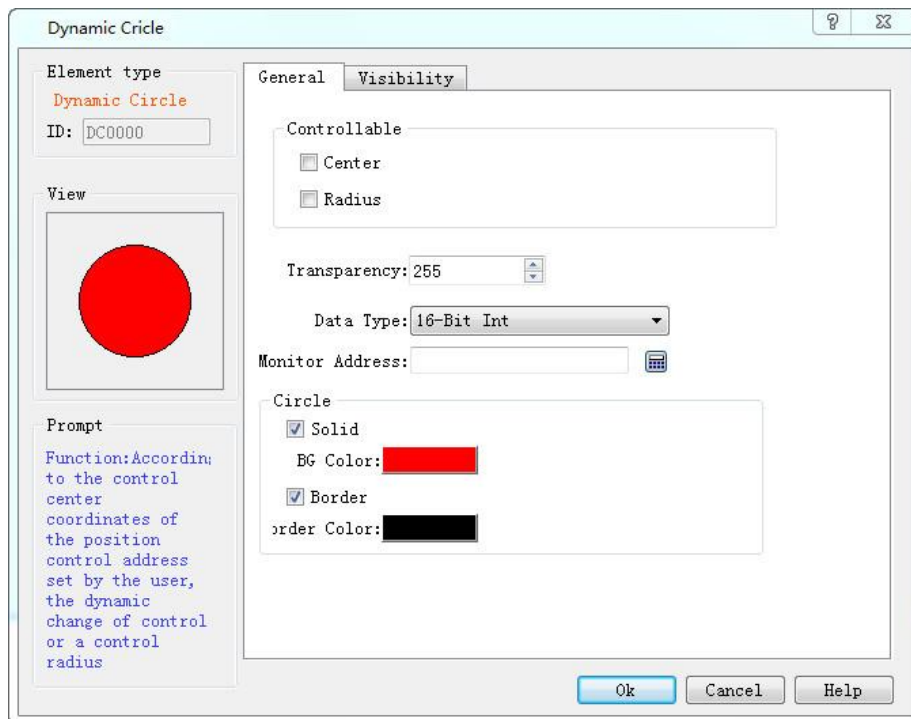

Figure 4-56 Dynamic circle dialog

Three sets of address values to be read by Dynamic circle represent the x-coordinate, y coordinates of the circle center and the radius of the circle respectively. The way that these three groups of addresses are read depends on the data type selected by the user.

➤ Control:

- Center: The circle moves according to the position of the center of the circle while the radius does not change.
- Radius: Just the radius size changes and the position do not move.
- Center & Radius: Not only the radius changes with the value of monitor address representing the radius of the circle, but also the center does with the value of monitor address representing the x, y coordinates of the circle center.



- Transparency: Change the transparency of the background color of a dynamic circle.

➤ Solid:

When user does not select Solid, the circle is an empty circle, which means it has no background color. Otherwise the circle is a solid circle; the background color option can change its background color.

➤ Border

When user does not select this option, the circle does not have change lines, and the color of the edge line cannot be changed. Otherwise, the circle is a circle with an edge line; border color options can change the color of the edge line.

Here's an example:

Select the data type "16-bit integer", and read out three sets of data consecutively to represent respectively the x coordinate, y coordinate of the center and circle radius, according to address formats of different PLC models. When the monitor address is LW1, it needs to read the address values of LW1, LW2 and LW3. The meaning of the address is as follows:

The value of LW1 is the x-coordinate of the circle center.

The value of LW2 is the y-coordinate of the circle center.

The value of LW3 is the radius of the circle.



Regardless of whether selecting Center or Radius in the control option, HMI will still read three groups of address, which represent the same meaning. For example, you select the radius in the control bar, and the monitoring address is LW1, then still only value of LW3 can control the radius of the circle.

When select the data type "32-bit integer" and the monitor address is LW1, then it needs to read the address values of LW1, LW2 and LW3. The meaning of the address is as follows:

The value of LW1 is the x-coordinate of the circle center.

The value of LW3 is the y-coordinate of the circle center.

The value of LW5 is the radius of the circle.

When select the data type "32-bit integer", according to the address format of different PLC models, you can add 2 at interval to the monitor address to acquire three sets of data representing the x coordinate, y coordinate of the circle center and the radius respectively.



The "Visibility" page can refer to that of "Bit Button" control.

## 6.4.6 Dynamic Rectangle

Functions of dynamic rectangle are similar to those of dynamic circle. They all reflect the dynamic state of monitor address in real time by changing the position or size of the graph according to different values of monitor address.

Select the dynamic rectangle icon  in the toolbar to bring up the dialog box shown in Figure 4-57.

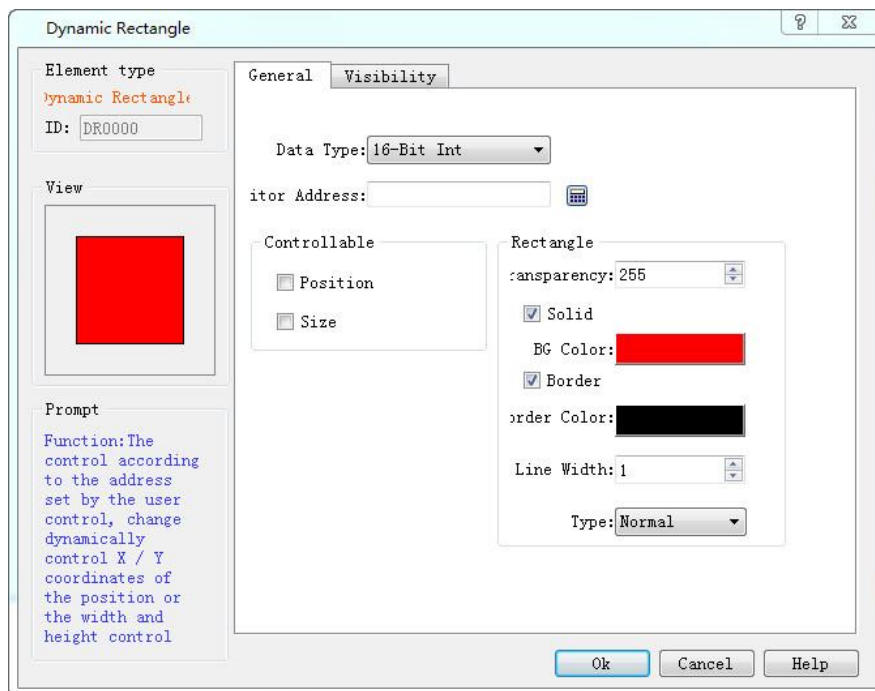

Figure 4-57 Dynamic rectangle dialog

The dynamic rectangle needs to read four sets of address values to represent the x-coordinate, y-coordinate, the width and height of the rectangle respectively. The way to read these four groups of addresses depends on the data type selected by the user.

- Line Width: Change the width of the line
- Type: Select the right angle, clipped angle or round angle.
- Note: Type is effectual only when the line width value is greater than 1.

Here's an example:

When select the data type "16-bit integer" and the monitor address is LW1, then it needs to read the four sets of address values LW1, LW2, LW3, and LW4. Their meanings are as follows:

The value of LW1 is the x coordinate of the rectangular;

The value of LW2 is the y coordinate of the rectangular;

---

The value of LW3 is the width of the rectangle;

The value of LW4 is the height of the rectangle.

In the case of selecting a data type of "16-bit integer", the user can read four sets of data consecutively according to the address specification format of the PLC model to represent the rectangle x coordinate, rectangle y coordinate, and rectangle width and height, respectively.

When the user selects the data type as "32-bit integer" and the address LW1 is monitored, the address values of LW1, LW3, LW5, and LW7 need to be read out.

The value of LW1 is the rectangular x coordinate;

The value of LW3 is the rectangular y coordinate;

The value of LW5 is the width of the rectangle;

The value of LW7 is the height of the rectangle;

When select the data type "32-bit integer", according to the address format of different PLC models, you can add 2 at interval to the monitor address to acquire four sets of data representing the x coordinate, y coordinate, the width and the height of the rectangle respectively.

**Control:**

- Position: The height and width of the rectangle does not change with the corresponding monitor address value while the position of the rectangle changes with the monitor address value that represents the x and y coordinates of the rectangle.
- Size: The height and width of the rectangle changes with the following four fixed points, but the position of the rectangle does not change.
- Upper Left: The fixed point of the rectangle is in the upper left corner, and it extends in the direction of the lower right corner.
- Upper right: The fixed point of the rectangle is in the upper right corner, and it extends in the direction of the lower left corner.
- Lower Left: The fixed point of the rectangle is in the lower left corner, and it extends in the direction of the upper right corner.
- Lower right: The fixed point of the rectangle in the lower right corner, and it extends in the direction to the upper left corner.

**Solid:**

When user does not select Solid, the rectangle is an empty one, which means it has no background color. Otherwise it is a solid rectangle; the background color option can change its background color.

**Border:**

When user does not select this option, the rectangle does not have change lines, and the color of the edge line cannot be changed. Otherwise, it is a rectangle with an edge line; border color options can change the color of the edge line.

Transparency: Change the transparency of the background color of the dynamic rectangle control.



The "Visibility" page can refer to that of "Bit Button" control.

## 6.4.7 Alarm Display

---

The alarm control can display the alarm information of the current equipment (digital alarm and analog alarm). Before executing this control, it needs to configure the alarm settings. For ways to configure the alarm settings please refer to "Alarm setting".

Alarm control can store real-time alarm information, and the number of alarms is determined when you configure. SKTOOL supports digital alarm messages.

Add the alarm control:

Select the Alarm Control in the Tool menu or select the Alarm Control button  in the Toolbar menu; a dialog box shown in Figure 4-58 will pop up:

Figure 4-58 Alarm Display dialog

In the alarm display box, you can set the color and size of the display frame, color and type of the grid line, the time, date and color of alarm title. In the Text box, you can also set font size, text color and number of rows of alarm message. If the row is set to 5, then the alarm control can display 5 alarm messages, when there is a new alarm occurs, the earlier one will be replaced.

Language: For different languages, font size, font, time, date and message content can be different while the background color and text color are the same as the first language.

Select all alarm contents: When this option is selected, the alarm display control will display all the alarm information of "Digital Alarm" and "Analog Alarm" in the Project Manager; otherwise, only the specified alarm information selected by the user is displayed.

Set up and press OK, then left click to draw the alarm control on the screen, as shown in Figure 4-59:

| Time | Date | Message |
|------|------|---------|
|      |      |         |
|      |      |         |
|      |      |         |
|      |      |         |

Figure 4-59 Alarm Display control



### Tips:

- The size of the alarm control is determined by the rows and the maximum character size of the alarm. The mouse can resize it and the position of the alarm control can be adjusted.
- When the number of alarm content branches is bigger than that of rows, the alarm control will automatically add one row, as well as a scroll bar to display the alarm information.
- The "Visibility" page can refer to that of "Bit Button" control.

## 6.4.8 Alarm Bar

The Alarm Bar is used to display the current alarm. It differs from the alarm control in that the dynamic alarm bar displays the current alarm contents (digital alarm contents and analog alarm contents) in the form of text scroll.

If there are three alarms, then the dynamic alarm bar will scroll display the first alarm, then the second, and finally the third, and so on. The scroll direction is from right to left, but it is also possible to make it from left to right; the speed, movement interval time and alarm sound are determined by the properties; please refer to "Alarm display setting". Before using the dynamic alarm bar, you need to configure the alarm settings; refer to "Alarm settings" please.

Add the alarm bar:

Select the Alarm Bar or the button  in the Tool menu, as shown in Figure 4-60:

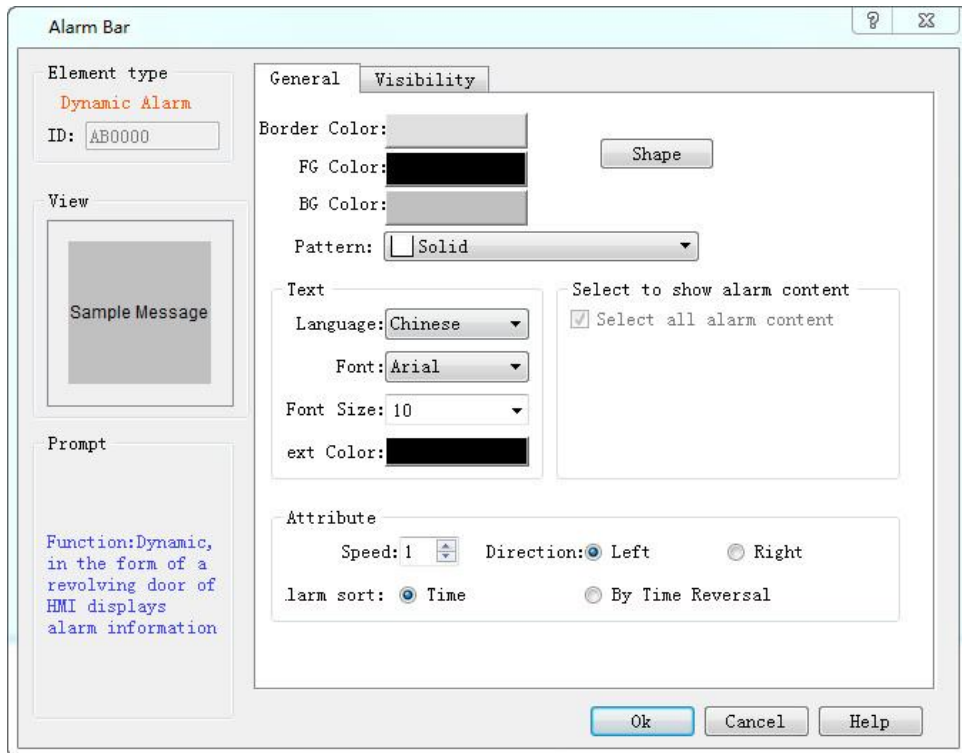

Figure 4-60 Alarm Bar dialog

Select all alarm contents: When this option is selected, the alarm display control will display all the alarm information of "Digital Alarm" and "Analog Alarm" in the Project Manager; otherwise, only the specified alarm information selected by the user will be displayed.

- Language: For different languages, font size, font, time, date and message content can be different, and the background color and text color are the same as the first language.
- Font: Change the font format of the alarm contents
- Font Size: Change the font size of the alarm content
- Text color: Change the font color of the alarm contents
- Speed: Movement step of the alarm contents.
- Direction: The moving direction of the alarm content ( Left or Right)
- Alarm Sort: The order of the alarm display.



- Application of shape, border color, background color, foreground color and pattern can be used with reference to "Bit Button" control.
- When calling off-line simulation, the font size should be "16x16"; in other case, you can choose otherwise.
- The "Visibility" page can refer to that of "Bit Button" control.

## 6.4.9 Historical Alarm Display



The main function of Historical Alarm is to display the previous alarm contents; the operation is the same with that of Alarm display, which means you can refer to the application of the alarm display. Click the

Historical Alarm button  on the toolbar to bring up the following dialog box:

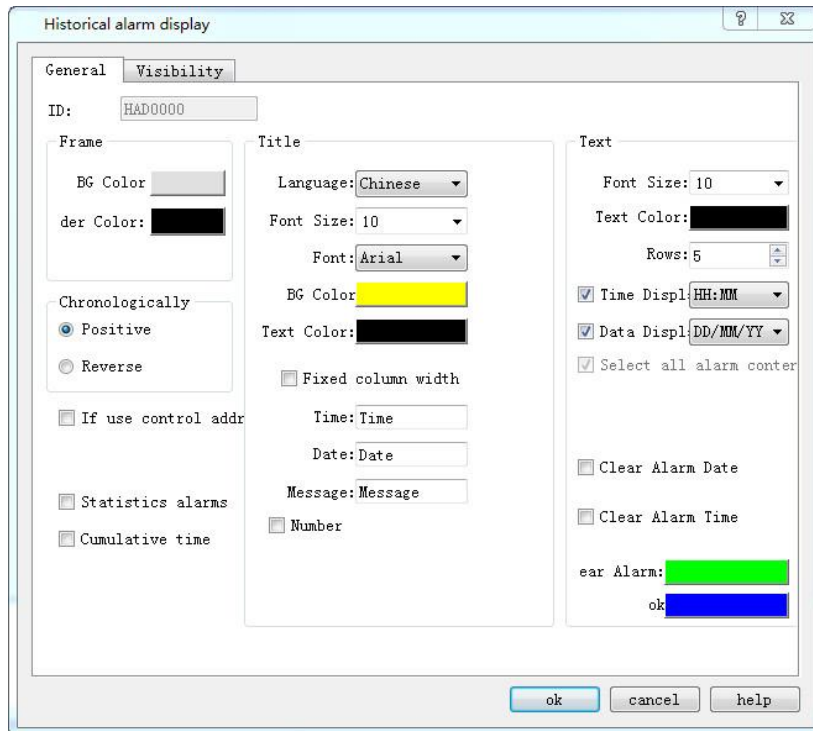

Control address: Write 1 to the address register 0 in address offset (16-bit integer, same to 1 to 12); write the start time to address register 1~ 6 in address offset, and write the end time to that of address register 7 ~ 12. Then the historical alarm display will show the data content during the corresponding time. If you want to display all the historical alarm information, write 0 to the 0 address register. Address Register 13 in Address Offset is not useful for now.

This address occupies 12 consecutive address offset; the meaning of each is as follows:

|                |   |
|----------------|---|
| Address offset | Controlled object by control register address |
|----------------|---|

|    |  |
|----|--|
| 0  | 1 represents display the data between the start and end time; 0 means all data is displayed. |
| 1  | Start time (Year)  |
| 2  | Start Time (Month)   |
| 3  | Start time (Day)   |
| 4  | 4Start Time (Hour)   |
| 5  | Start Time (Min)   |
| 6  | Start Time (Second)  |
| 7  | End time (Year)  |
| 8  | End Time (Month)   |
| 9  | End Time (Day)   |
| 10 | End Time (Hour)  |
| 11 | End time (Minute)  |
| 12 | End time (Second)  |

- Clear alarm date: Cancel the alarm date
- Clear alarm time: Clear the alarm time
- Clear alarm: The line used to remove the alarm is marked with this color
- Statistics alarms: Enable alarm count, which is showed after the alarm message.
- Cumulative time: Enable alarm cumulative time, which is showed after the alarm message.
- OK: Indicate the alarm with this color when it is generated



The basic operation can refer to "Alarm Display" control.  
The "Visibility" page can refer to that of "Bit Button" control.

## 6.4.10 Graphic Move



With the Graphic Move control, a gallery graphic or graphic file can move in a specific direction on the screen, and the associated variable value can trigger the movement of the variables. This control can produce an animation effect on the screen.

Add the Graphic Move control and modify its properties:

Select the Graphic Move command button  in the toolbar; set the properties in the dialog box that pops up; and click OK, as shown in Figure 4-61:



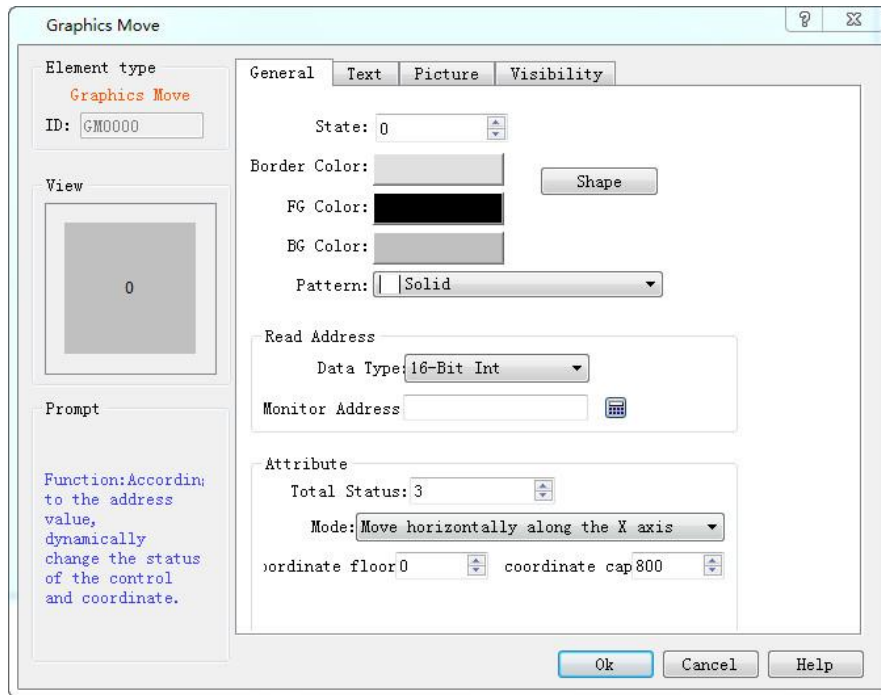

Figure 4-61 Graphic Move dialog

➤ Picture selection:

On the Pictures page, select a picture as a moving graphic that can also be customized.

➤ Monitor Address:

The monitor address for the change of graphic movement occupies three addresses, which correspond to the change of the total status, the value of the X axis and the value of the Y axis. For example, assuming the monitor address is LW1 in the internal memory and the data type is 16 Bit. (Then the value change of LW1, LW2, LW3 can directly control the total number of state, X-axis movement and Y-axis movement); if data type is 32 Bit, then the monitor address of Total Status is LW1, that of X coordinate is LW3 and that of Y coordinate is LW5.

➤ Method: The following examples all take LW1 in internal storage address as the monitoring address, and the data type is 16 Bit. As an example to illustrate each movement:

- Move horizontally along the X axis: The graph moves only horizontally, but not vertically; can not move below the lower limit of X axis or above the upper limit of X axis. The total number of status is the value of the monitor address LW1 and that of the LW2 represents the X coordinate.
- Move vertically along the Y axis: The graph moves only vertically, but not horizontally; can not move below the lower limit of Y axis or above the upper limit of Y axis. The total number of status is the value of the monitor address LW1 and that of the LW2 represents the Y coordinate.
- Move horizontally and vertically in the mean time: The graph can move in horizontal and vertical direction at the same time; it cannot move below the lower limit of X-axis or above the upper limit of

X-axis horizontally, or move below the lower limit of Y axis or above the upper limit of Y axis vertically. The total number of status is the value of the monitor address LW1, that of the LW2 represents the X coordinate and that of LW3 represents the coordinate.

- Move horizontally and proportionally along the X axis: The graph moves only horizontally, but not vertically; can not move below the lower limit of X axis or above the upper limit of X axis. The total number of status is the value of the monitor address LW1 and that of the LW2 represents the X coordinate.
- Move vertically and proportionally along the Y axis: The graph moves only vertically, but not horizontally; can not move below the lower limit of Y axis or above the upper limit of Y axis. The total number of status is the value of the monitor address LW1 and that of the LW2 represents the X coordinate.
- Move anti-horizontally and proportionally along the X axis: The graph moves only horizontally, but not vertically; can not move below the lower limit of X axis or above the upper limit of X axis. The total number of status is the value of the monitor address LW1 and that of the LW2 represents the X coordinate.
- Move anti-vertically and proportionally along the Y axis: The graph moves only vertically, but not horizontally; can not move below the lower limit of Y axis or above the upper limit of Y axis. The total number of status is the value of the monitor address LW1 and that of the LW2 represents the X coordinate.



- As for "Text" and "Picture" pages, refer to those of the "Multi-state Indicator" control.
- The "Visibility" page can refer to that of "Bit Button" control.
- Changing the values of the last two monitor address can control the position of the graphic movement.
- The maximum coordinate of the X / Y-axis is the maximum value of the screen.

## 6.4.11 Meter

---

The Meter control can display the current value of associated variables through a pointer; generally the control is a semicircle or circular, which can be a visual representation of the actual situation of the variable.

Add the Meter control and modify the properties:

1. Select the Meter control icon  in the toolbar; then the dialog box shown in Figure 4-62 appears:

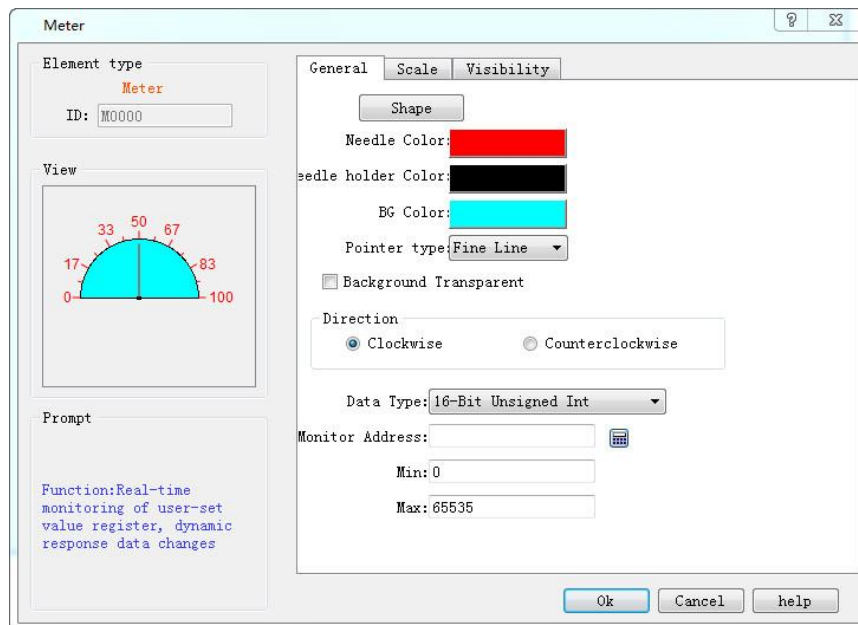

Figure 4-62 Meter dialog

- Needle color: Change the color of the pointer
- Needle holder Color: Change the color of the needle holder
- Background color: Change the background color of the dial
- Pointer type: Fine Line, Thick Line, Diamond and Triangle
- Background transparency: Whether the control is transparent
- Direction: Select the clockwise or counterclockwise direction
- Data type: Choose different data types according to their needs
- Monitor address: Read the address value that is shown by the pointer on the dial plate.
- Maximum: Set the maximum value that cannot be exceeded by the monitor address value
- Minimum: Set the minimum value that the monitor address value cannot be lower than

2. Click the Scale tab to set the scale properties, as shown in Figure 4-63:

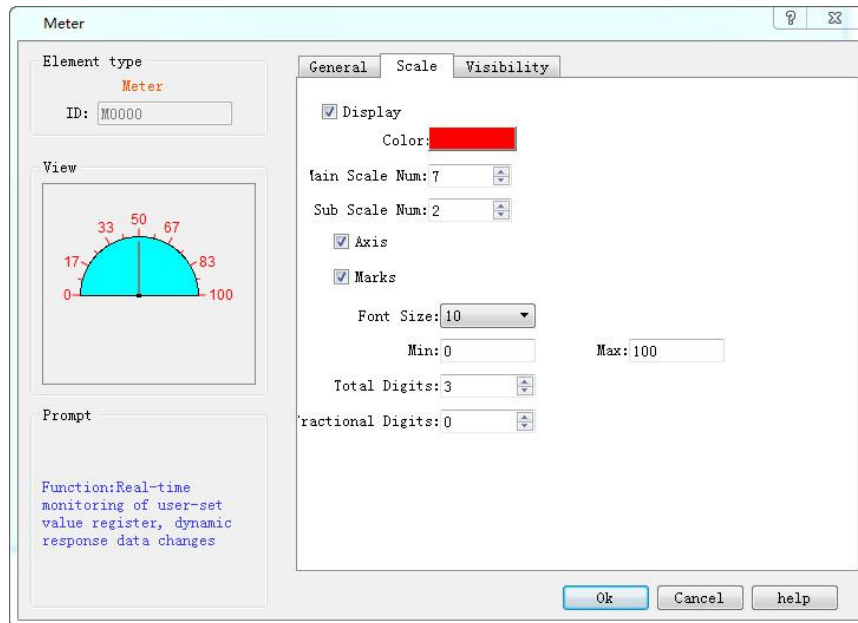

Figure 4-63 Scale tab of Meter

On this page, you can set the color, number of major scale, number of sub-scale, and whether to display the axis and whether to display the scale marks, etc.

3. In the screen editing area click to draw the control. The effect diagram of the Meter control is as follows:

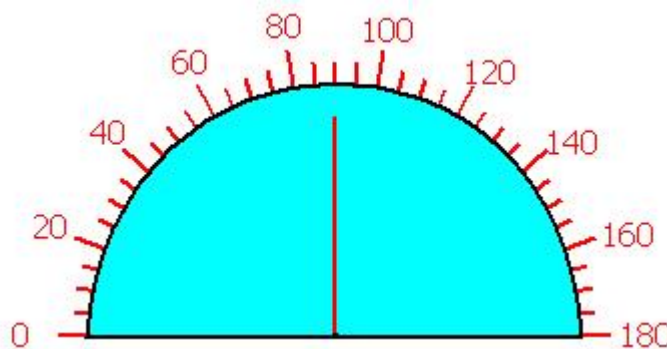

Figure 4-64 Meter control

4. Select the Meter control graph, move the mouse on the 8 small green dots to modify its size; double-click to re-modify the control properties.



Meter control has a fixed aspect ratio; if modify the size, its length and width enlarge or shrink in the

meantime.

The "Visibility" page can refer to that of "Bit Button" control.

## 6.4.12 Historical Data Display



In actual use, data generated from PLC or other connected equipment can update at any time, such as alarm. When it comes to historical data, we can use the historical data collector in SKTOOL to observe the historical data.

SKTOOL provides the function of historical data collector. Enter the Historical data collector dialog box in the project manager. If it is a new project, right-click the "Historical data collector" to add one; then double-click "Historical Data Collector 0" to enter the setting dialog box. For details, refer to properties of "[History Data Collector](#)" in Chapter 6.

Click on the historical data display button  on the toolbar, and the following dialog box will pop up:

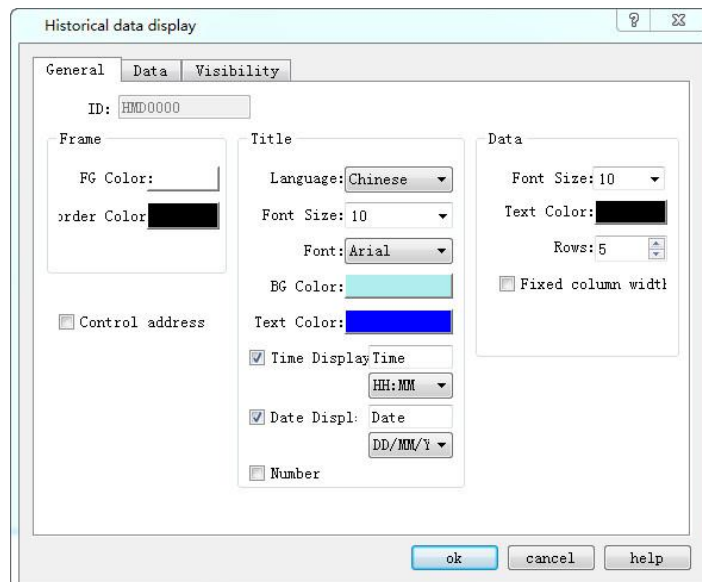

Figure 4-65 Historical Data Display dialog

### General:

- Foreground Color: Click the color inside the box to change the foreground color of the display.
- Border Color: Click the color inside the box to change the color of the display border.

- Title: Choose the font size, font style, background color, text color and whether to display the date and time. Language settings can be referred to that of "Alarm Display".
- Data: Choose the font size, color, and the maximum line numbers to be displayed.

Control address:

Write 1 to the address register 0 in address offset (16-bit integer, same to 1 to 12); write the start time to address register 1~ 6 in address offset; write the end time to that of address register 7 ~ 12; at last write 1 to address register 13. Then the historical data display will show the data content during the corresponding time. The address register 13 will automatically reset. If you want to display all the historical alarm information, write 0 to the address register 0.

This address occupies 40 offset addresses consecutively. Meaning of each address is as follows:

| Address offset | Controlled object by control register address  |
|----------------|--|
| 0              | 1 represents display the data between the start and end time; 0 means all data is displayed.   |
| 1              | Start time (Year); one word  |
| 2              | Start Time (Month); one word   |
| 3              | Start time (Day); one word   |
| 4              | Start Time (Hour); one word  |
| 5              | Start Time (Min); one word   |
| 6              | Start Time (Second); one word  |
| 7              | End time (Year); one word  |
| 8              | End Time (Month); one word   |
| 9              | End Time (Day); one word   |
| 10             | End Time (Hour); one word  |
| 11             | End time (Minute); one word  |
| 12             | End time (Second); one word  |
| 13             | Value is from 0 to 1 and the value of address offset 0 is 1, then display the data during particular period; reset automatically; one word |
| 14             | All the historical data information between the start time and end time; double word   |

Data:

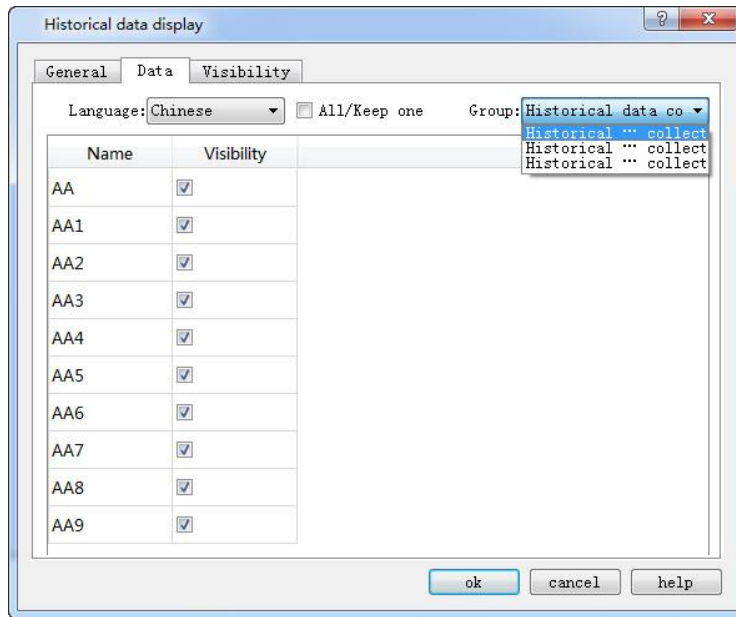

Group number: SKTOOL provides multi-group historical data to choose.

Historical data display operation: When display historical data through control addresses, the configuration process is as follows 4-65-1:

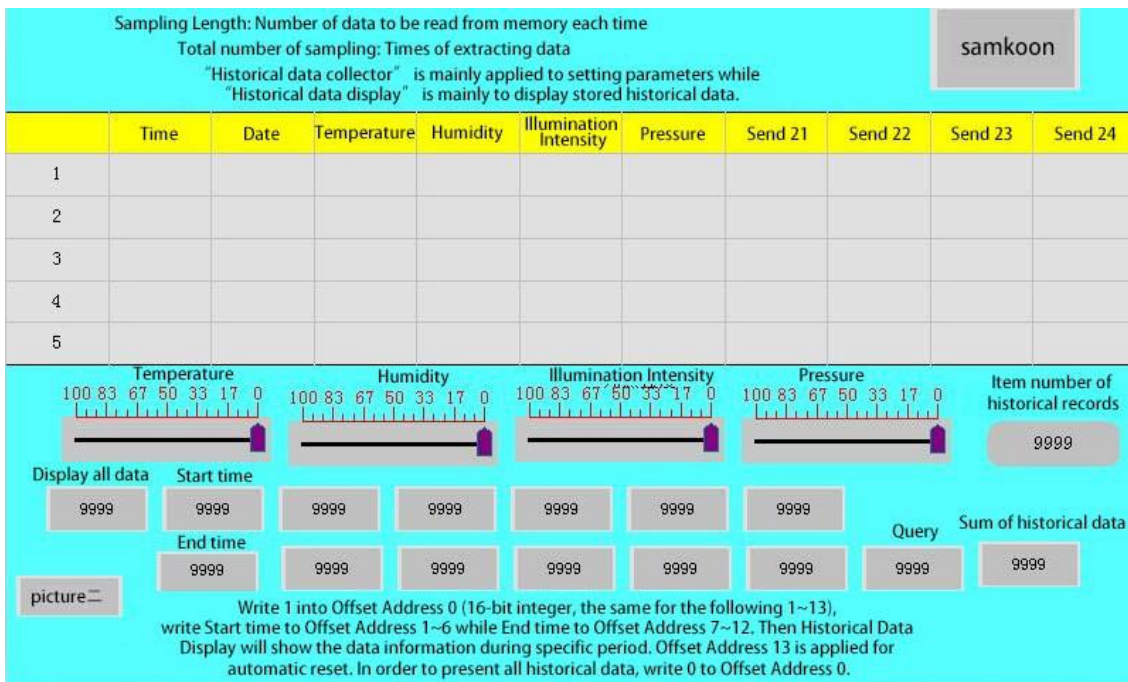

Figure 4-65-1

In this operation, input 1 to "Display all data", 1 to "Inquire", then the data collector will display all the historical data during the start time and the end time period. As shown in Figure 4-65-2

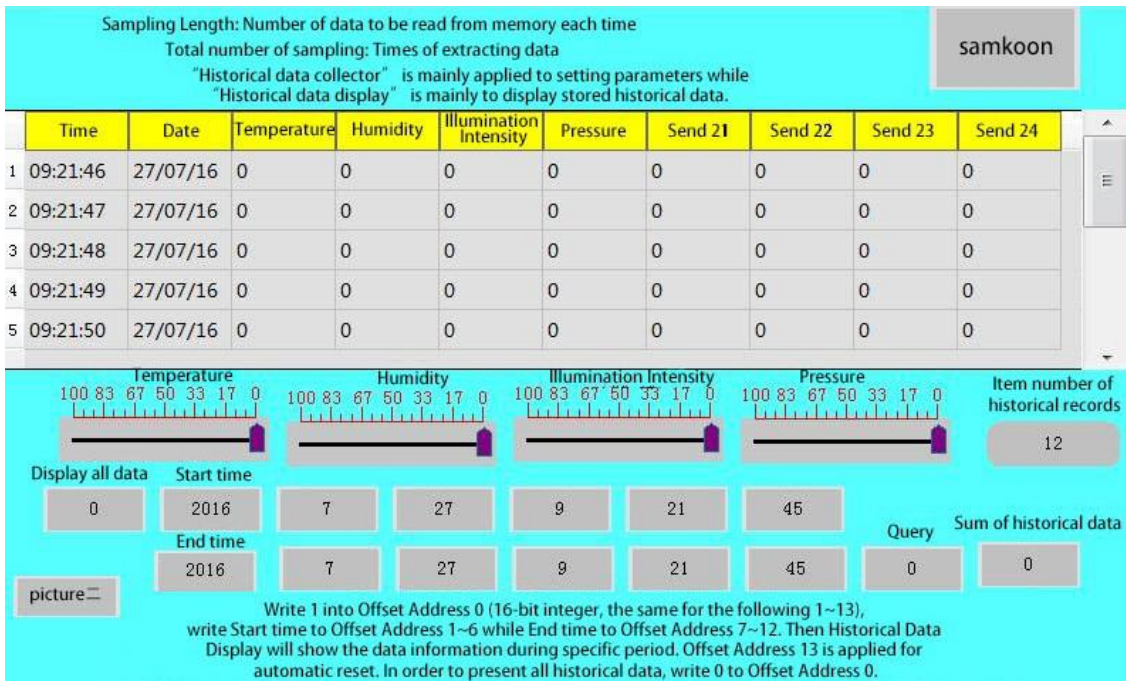



Figure 4-65-2

Input 1 to "Display all data", set the start time as 2016-7-11 3: 30: 4 and the end time as 2016-7-11 14: 39: 4; when the input value of "Inquire" is 1, then it only displays the data during this time.



The "Visibility" page can refer to that of "Bit Button" control.

### 6.4.13 Message Display

Message Display functions similarly to the multi-state indicator, except that the total states number of the message display control increases, which is up to 128. This control icon on the toolbar is , click it to bring up a dialog box as shown in Figure 4-66:



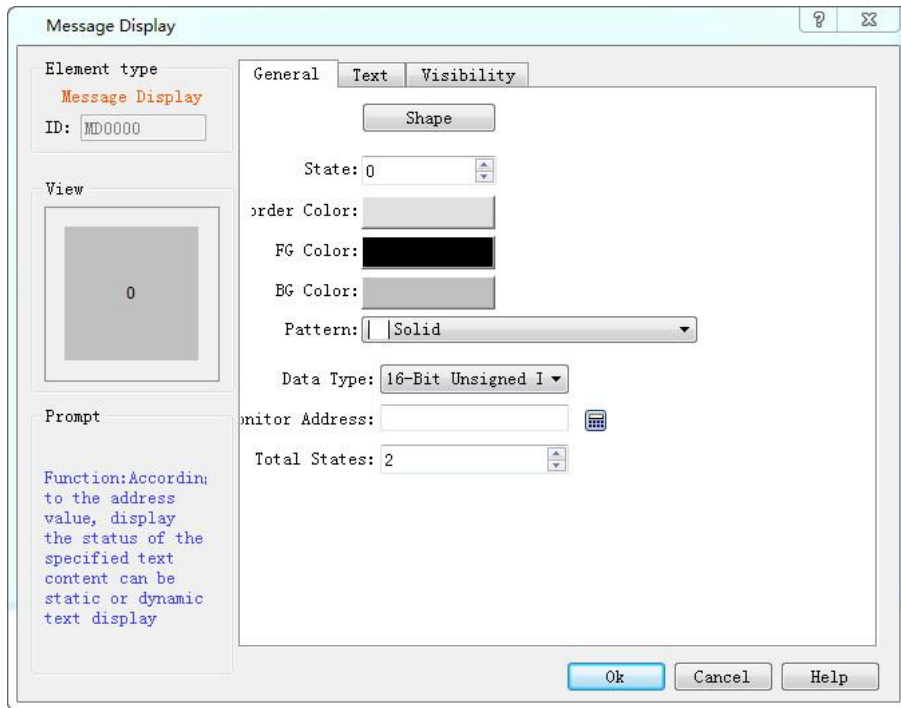

Figure 4-66 Message Display General page

The Text page of Message Display is shown in Figure 4-67:

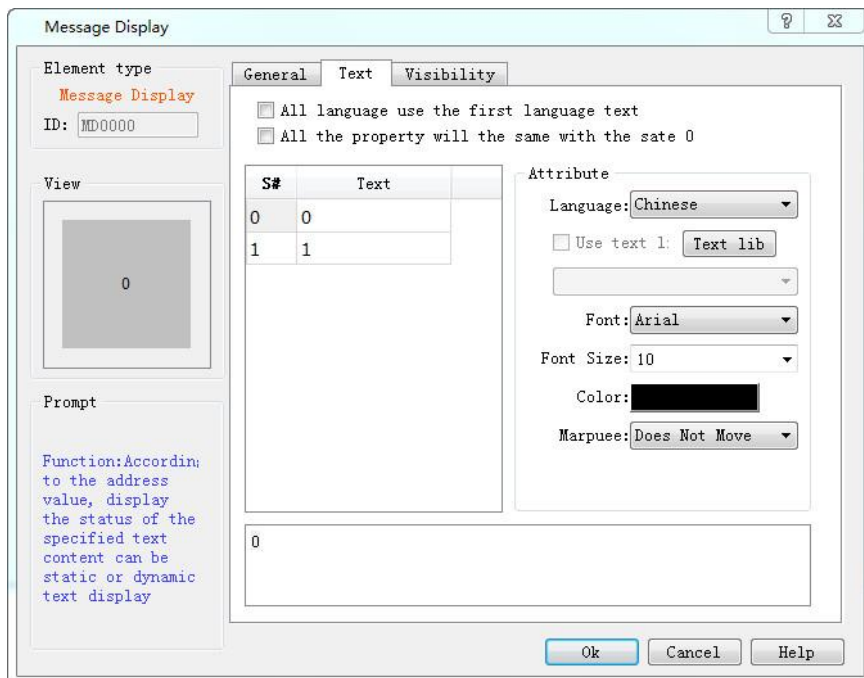

Figure 4-67 Text page of Message Display

The language, font, font size and color settings can refer to those of the multi-state indicator control.

- Cursors: This item has three options-- Not move, Left and Right.
- Not move: The current state of text is static.

- Left: Text in the current state moves to the left at the speed (assumed to be n) set by user by n pixel value.
- Right: Text in the current state moves to the right at the speed (assumed to be n) set by user by n pixel value.



As for Property settings, you can refer to the attributes of "Multi-state indicator" control.

## 6.4.14 Flow block

A Flow block is an animated graphic that simulates the liquid flow within a pipe. Whether to flow is determined by the state of the trigger address. When the trigger address is 1, the Flow block is in flow state;

while when it is 0, the Flow block is in static state. User determines the flow speed. Click the button  on the toolbar, and then it appears a pop-up dialog box, as shown below:

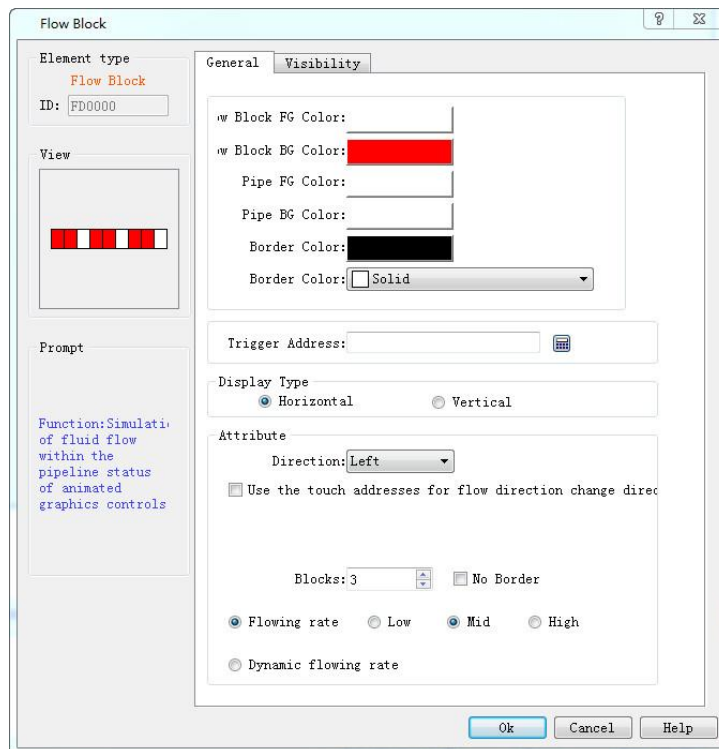

Color: Set the color properties of the Flow block.

- Flow block foreground color: Click on the color button to set the Flow block foreground color;
- Flow block background color: Click on the color button to set the Flow block background color;
- Pipe foreground color: Click on the color button to set its foreground color;
- Pipe background color: Click on the color button to set the pipe background color;
- Border color: Click on the button to set the border color of the Flow block control;

- Pattern: Click to select the pattern of the Flow block control; the default setting is "Solid".
- Trigger Address: Address that controls the stationary or moving of the Flow block; when the value of the address is 1, then the block flows.
- Attribute: Set the properties of the Flow block, such as direction, flow speed.
- Display Mode: Select "Horizontal" to make the Flow block move horizontally; and select "Vertical" to make it flow vertically.
- Direction: When the display mode is "Horizontal", you can choose "Left" or "Right"; in another case, "Up" or "Down".
- Change the flow direction to the opposite direction through the trigger address: when the "Trigger address" value is equal to that of the "Effective status" set by user, the Flow direction is switched to the opposite.

For example, If "Flow direction" is "Left", this option is selected, "Trigger address" is LB2, and "Effective Status" is set to 1, then when the value of LB2 is 1, the direction of the Flow block is switched to "Right", while when the value of LB2 is 0, the direction is changed back to the original "Left".

- Blocks: The number of Flow units, ranging from 1 to 30;
- No Border: When this attribute is selected, the edges of the Flow block are hidden.
- Flow rate: Either fixed rate or dynamic rate
- Fixed Flow rate: High, Middle or Low.
- Dynamic Flow rate: The Flow rate is determined by the value of a word address, which should be between 1 and 10. When the value is 0, the Flow block does not flow; When the value is 1, the Flow block flows at the lowest rate; When the value is 10, the Flow block flows at the highest rate.



The "Visibility" page can refer to that of "Bit Button" control.

## 6.4.15 Timer



A timer is a control that uses a time condition to trigger a specific function. In the SKTOOL configuration software, the timer is used as a control triggered by macro commands. Click on the toolbar  or double-click on an existing property timer will enter the timer settings page:

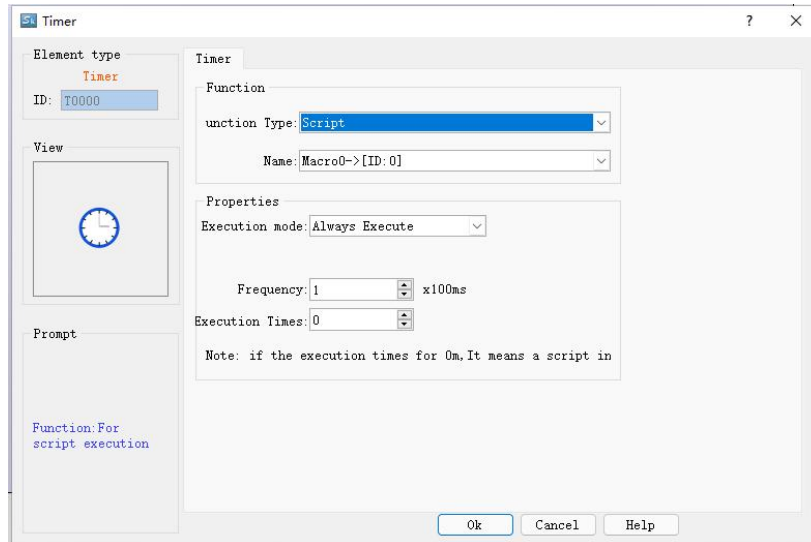

Control mode: Select the execution mode of macro instruction as always execute or address trigger.

1. "Always execute" is always executed according to the set frequency, and if always trigger is selected, the selected macro command will always be executed according to the set frequency when the project is running;
2. "Address trigger" means that when the value of the specified bit is 1, it will execute at the set frequency, and when the value of the specified bit is 0, the macro command will not be executed.

Address: When the execution mode of "address trigger" is selected, the address input field will appear, and the bit that controls the execution of this macro instruction will be input here. When the value of this bit is 1, the macro instruction is executed.

Execution frequency: The frequency at which the selected macro is executed. The range is 0.1~60S.

Execution times: The number of times the selected macro instruction is executed. When the number of times is 0, the macro instruction will be executed all the time.

Function type: Select the type of function to be executed. The function controlled by timer in HMITOOL configuration software is macro instruction.

Name: The name of the macro to be executed. The timer cannot be set when there is no macro command.

Use the timer variable to enable the timer function. The timer variable combination contains the following six variables:

| timer variable    | variable type      | narrative   |
|-------------------|--------------------|---|
| Input bit (IN)    | bit variable       | timer master switch                               |
| Timing Bit (TI)   | bit variable       | Set ON when timing starts                         |
| Output bit (Q)    | bit variable       | Set to ON when the setting is complete            |
| Preset Time (PT)  | word variable word | Set timer time value                              |
| Elapsed time (ET) | word variable word | Displays the current elapsed time of the timer    |
| reset bit (R)     | bit variable       | Reset the current timer elapsed time (ET) to zero |

## set up

Select the function button timer on the toolbox, select the timer in the function selection, this will pop up the timer setting, the default mode is the delay switch (ON), the default time unit is 0.1 seconds, the interface is as follows:

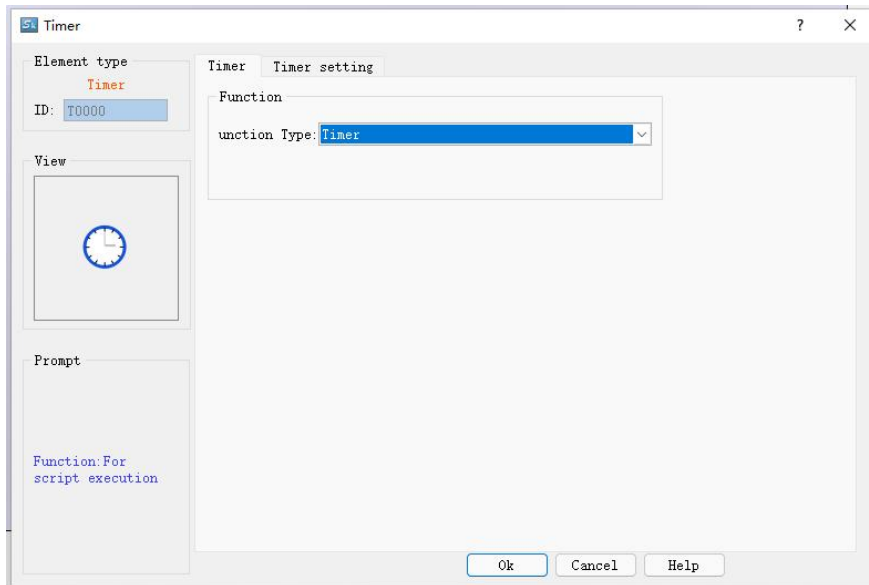

You can see the property setting address options at the bottom right, input bit, export bit, timing bit, preset time, enable elapsed time, and press the OK button after setting each property correctly, you can add a new one to the current configuration screen. The "Timer" component, as shown in the following figure:

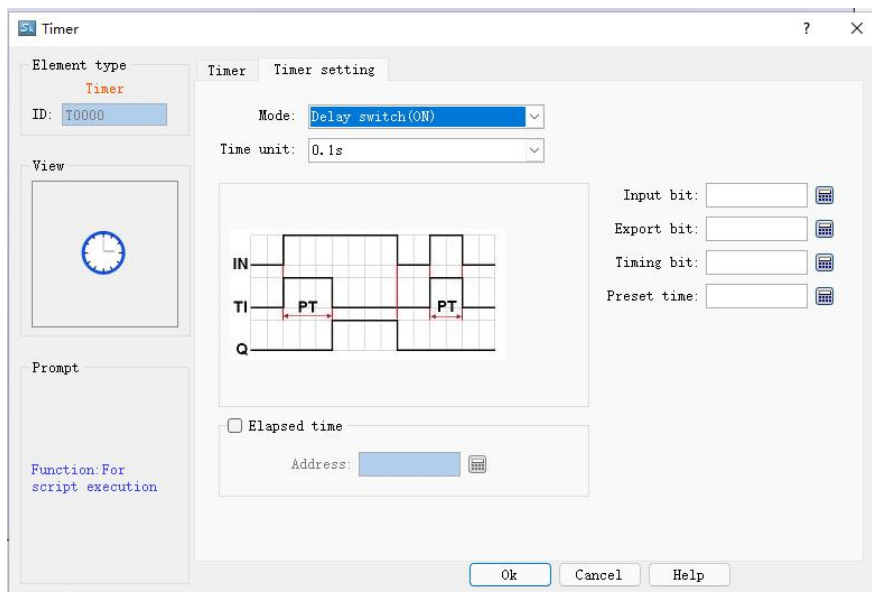

The following is an introduction to the functions of each mode:

### 1. Delay switch (ON)

- Input bit (IN): Input bit (IN): the main switch of the timer;
- Timing bit (TI): Set ON when timing starts.
- Output bit (Q): Set to ON after the timing is over.
- Preset Time (PT): Set the timer time value.
- Elapsed time (ET): Displays the current elapsed time of the timer.

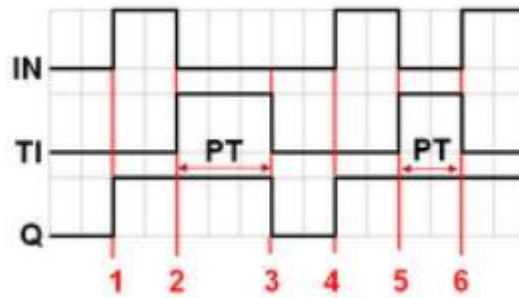

As shown in FIG:

- 1) When the input bit IN is set to ON, the timing bit TI is turned on, the elapsed time ET starts to count, and the output bit Q remains OFF.
- 2) When the counted time ET is equal to the preset time PT, the counted bit TI is turned off, and the output bit Q is turned on at the same time.
- 3) When the input bit IN is set to OFF, the output bit Q is turned off, and the elapsed time ET returns to zero.
- 4) When the input bit IN is set to ON, the timing bit TI is turned on, the elapsed time ET starts to count, and the output bit Q remains OFF.
- 5) When the input bit IN is set to OFF before the counted time ET reaches the value of the preset time PT, the counted time TI will be turned off and the counted time ET will return to zero.

## 2. Delay switch (OFF)

Input bit (IN): The main switch of the timer.

Timing bit (TI): Set ON when timing starts.

Output bit (Q): Set to ON after the timing is over.

Preset Time (PT): Set the timer time value.

Elapsed time (ET): Displays the current elapsed time of the timer.

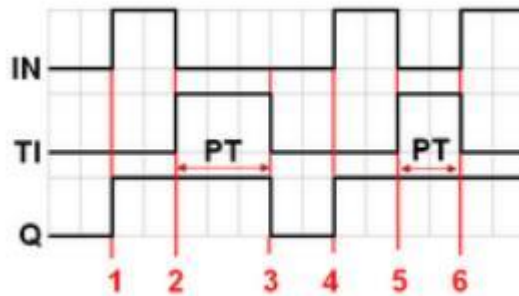

As shown in FIG:

- 1) When the input bit IN is set to ON, the timing bit TI remains OFF, the output bit Q is turned on, and the elapsed time ET returns to zero.
- 2) When the input bit IN is set to OFF, the timing bit TI is turned on, the output bit Q remains ON, and the counted time ET starts to count.
- 3) When the elapsed time ET is equal to the preset time PT, the output bit Q and the timing bit TI are turned off.
- 4) When the input bit IN is set to ON, the timing bit TI remains OFF, the output bit Q is turned on, and the elapsed time returns to zero.
- 5) When the input bit IN is set to OFF, the timing bit TI is turned on, the output bit Q remains ON, and the counted time ET starts to count.
- 6) When the input bit IN is set to ON before the counted time ET reaches the value of the preset time PT, the

counted bit TI is turned off, while the output bit Q remains ON, and the counted time ET returns to zero.

### 3.Pulse start switch

Input bit (IN): Main switch of the timer.

Timing bit (TI): Set ON when timing starts.

Output bit (Q): Set to ON after the timing is over.

Preset Time (PT): Set the timer time value.

Elapsed time (ET): Displays the current elapsed time of the timer.

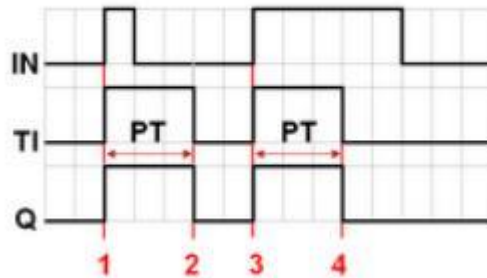

As shown in FIG:

- 1) When the input bit IN is set to ON, the timing bit TI and the output bit Q are turned on at the same time, and the counted time ET starts to count.
- 2) When the elapsed time ET is equal to the preset time PT, the output bit Q and the timer bit TI are turned off at the same time (because the input bit IN has been set to OFF while counting, the elapsed time ET will be automatically reset to zero).
- 3) When the input bit IN is set to ON, the timing bit TI and the output bit Q are turned on at the same time, and the counted time ET starts to count.
- 4) When the counted time ET is equal to the preset time PT, the output bit Q and the timing bit TI are turned off at the same time.

### 4.Cumulative delay switch (ON)

Input bit (IN): Main switch of the timer.

Timing bit (TI): Set ON when timing starts.

Output bit (Q): Set to ON after the timing is over.

Preset Time (PT): Set the timer time value.

Elapsed time (ET): Displays the current elapsed time of the timer.

Reset bit (R): resets the current timer elapsed time (ET) to zero.

As shown in FIG:

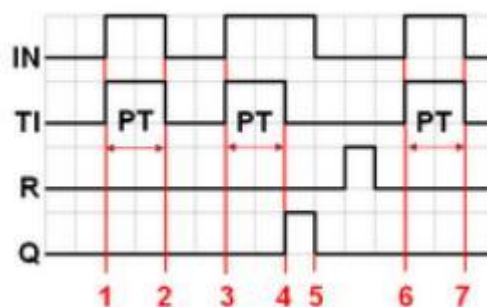

As shown in FIG:

- 1) When the input bit IN is set to ON, the timing bit TI is turned on, the counted time ET starts to count, and the output bit Q remains OFF.
- 2) When the input bit IN is set to OFF, if the counted time ET does not reach the preset time PT, the counted bit TI is turned off, and the output bit Q remains OFF. The elapsed time ET maintains the current state value.
- 3) When the input bit IN is set to ON again, the timing bit TI is turned on, and the elapsed time ET starts to count again from the state value just kept.
- 4) When the elapsed time ET is equal to the preset time PT, the timer bit TI is turned off, and the output bit Q is turned on at the same time.
- 5) The input bit IN is set to OFF, and the output bit Q is also turned off. (At this time, set the reset bit ON to reset the elapsed time ET to zero, and then set it to OFF.)

### 5.Cumulative delay switch (OFF)

- Input bit (IN): Main switch of the timer.
- Timing bit (TI): Set ON when timing starts.
- Output bit (Q): Set to ON after the timing is over.
- Preset Time (PT): Set the timer time value.
- Elapsed time (ET): Displays the current elapsed time of the timer.
- Reset bit (R): resets the current timer elapsed time (ET) to zero.

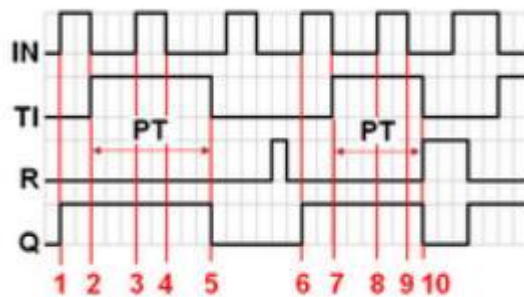

As shown in FIG:

- 1) When the input bit IN is set to ON, the timing bit TI remains OFF, and the output bit Q is turned on at the same time.
- 2) When the input bit IN is set to OFF, the timing bit TI is turned on, while the output bit Q remains ON. The elapsed time ET starts counting.
- 3) When the input bit IN is set to ON again, the timing bit TI and the output bit Q remain ON, and the counting time ET is suspended.
- 4) When the input bit IN is set to OFF again, the elapsed time ET starts to count again from the state value just held.
- 5) When the elapsed time ET is equal to the preset time PT, the timing bit TI and the output bit Q are turned off at the same time. (At this time, set the reset bit ON to reset the elapsed time ET to zero, and then set it to OFF.)



The size of the timer control cannot be changed, and the position can be set. When the project is running, the



timer control is not displayed on the HMI.

## 6.4.16 Multi-function Button



Multi-function button allows realizing the function of multi-step custom operation through one single control.

It can simplify user operation. Click  on the toolbar or double-click the existing multi-function button to enter the property page.

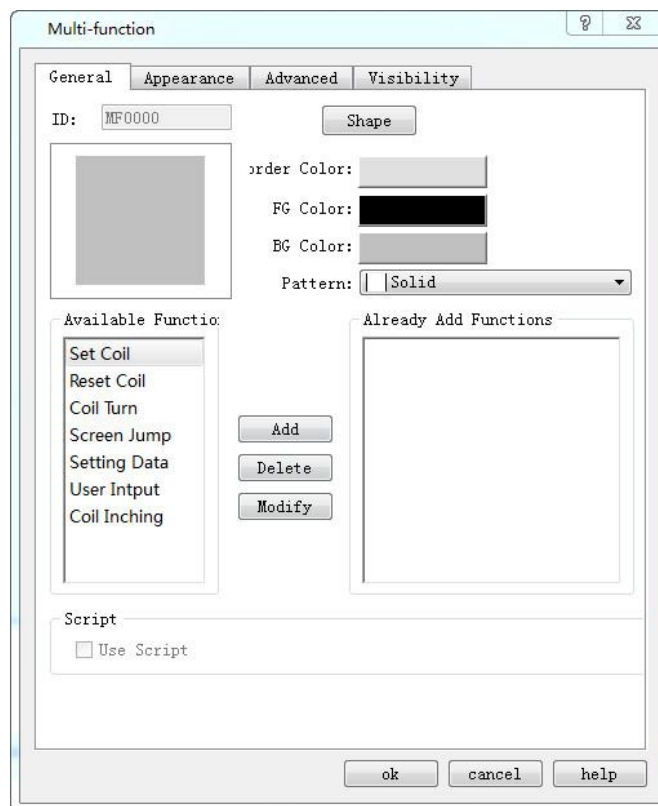

➤ General:

1. **Button Appearance:** shape, color, style, and other settings.

### 2. Available functions

Several functions are listed for user to select.

- Set Coil: Set the input address.
- Reset Coil: Reset the input address.
- Coil Alternation: Invert the input address value; if the address value is 0, then it becomes 1; if 1, it becomes 0;
- Coil Jog: When touched, the input address will be set; reset after releasing;
- Screen Jump: Jump to the selected screen. Modify it to choose the screen to jump to.

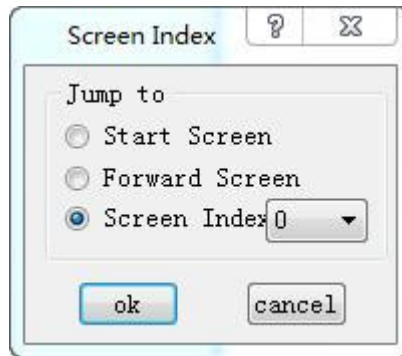

- Set data: Write the set value to the set address. You can select the type of data to be written, as well as the address and the data.

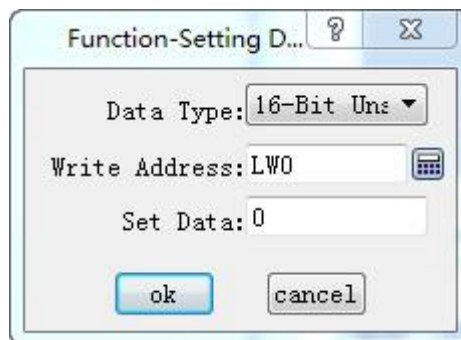

- User input: Enter a value and write it to the set address. You can select the data type to be written and set the address to be written. When this command is executed, it will appear the data input interface where you can perform the above operation.

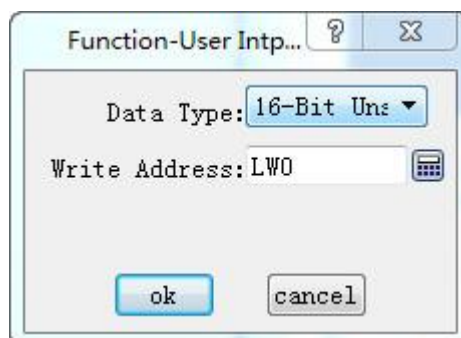

Select an available function and click Add to add the function to the list of selected features.

When "User Input" and "Coil Jog" are selected, only the User Input will be executed while the coil jog will not.

### 3.Added functions

When you select an available function, the function is listed here. Double click it or click "Modify" to set or modify. Click "Delete" to delete this function.

Clicking the multifunction button while the configuration is running means performing all of the selected functions.

#### 4. Macro

Select "Execute Macro" to see the list of macros. Choose a macro, and click the multi-function button to execute it when the project runs.



Label, Advanced and Visibility settings: Refer to those of the Bit Button.  
Refer to "Bit Switch" for hot keys of Advanced.

### 6.4.17 Pie Chart

A pie chart is used to show the proportion of a certain part, simply and clearly. Click  on the toolbar or double-click the existing Pie Chart button to enter the Property page.

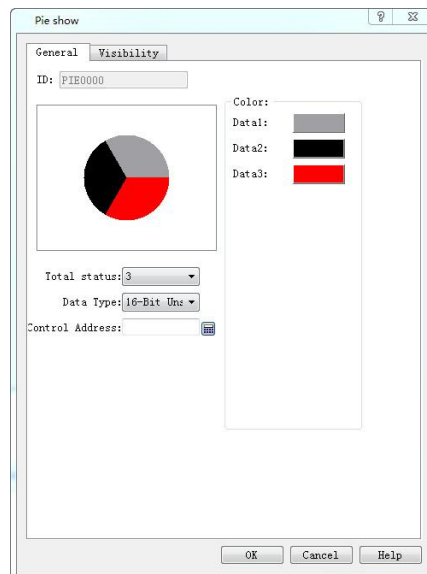

- Total: Quantity of components. Up to 12 pieces of data can be chosen.
- Data type: what type of data is selected for each type.
- Control Address: The written address is the first needed data address. The following address is the continuous one of the first. For example, the total quantity is 3, the data type is a 16-bit positive integer, and the control address is LW5, then the address of data 1 is LW5, that of data 2 is LW6, and that of data 3 is LW7.

---

If the data type is 32-bit and the control address is LW5, then the address of data 1 is LW5, that of data 2 is LW7, and that of data 3 is LW9.

- Color: Set the color of each data.

## 6.5 SKTOOL Basic controls

---

This chapter mainly introduces the use of basic controls of SKTOOL.

### Contents:

- [Bit Button](#)
- [Word Button](#)
- [Bit Lamp](#)
- [Screen Button](#)
- [Function Button](#)
- [Multi-state Indicator Lamp](#)
- [Multi-state Button](#)
- [Numeric Display](#)
- [Numeric Input](#)
- [ASCII Display](#)
- [ASCII Input](#)
- [Bar Chart](#)
- [Time Display](#)
- [Date Display](#)

- Week Display
- Static Picture
- Picture Display

## 6.5.1 Bit Button



Bit button is used to operate and display the ON/OFF status or 1/0 status of the bit address of the device connected with the touch screen. Bit button is the most fundamental and frequently used control.

Steps to set a Bit button:



1. Click the Bit Button icon on the toolbar to bring up a dialog box, which is for setting the properties of Bit Button, as shown in Figure 4-68:

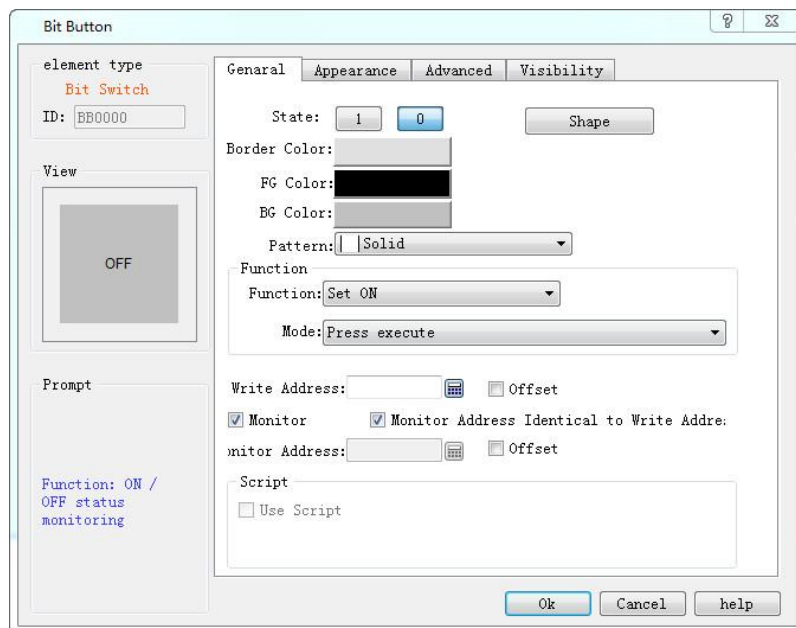

Figure 4-68 Bit Button dialog box

2. The dialog box includes four items, that is, General, Mark, Advanced and Visibility.

Shape: Click the Shape button to select a shape for the control graph, as shown in Figure 4-69

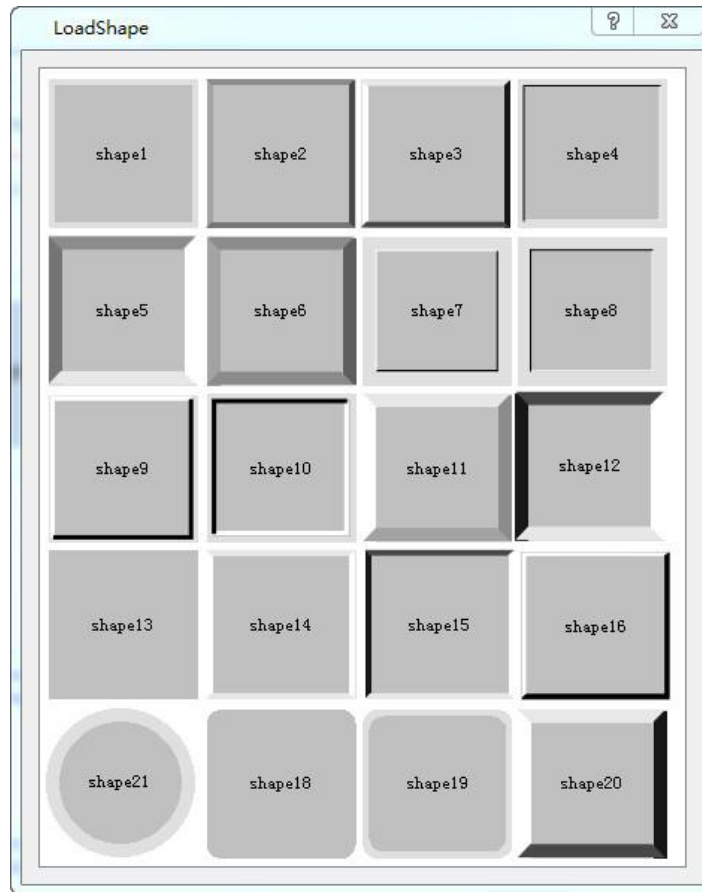

Figure 4-69 Shape pop-up dialog

- ◆ Border Color: When having chosen a shape with border, click this button to select a different color for the border.
- ◆ Foreground Color: When it needs to change the foreground color, click this button to choose a different foreground color on the drop-down color selection box. (Foreground color works only if the transition style is selected).
- ◆ Background Color: When it needs to change the background color, click the button to select on the drop-down color selection box.
- ◆ Pattern: Click the drop-down box, which contains a total of 21 kinds of patterns as shown in Figure 4-70:

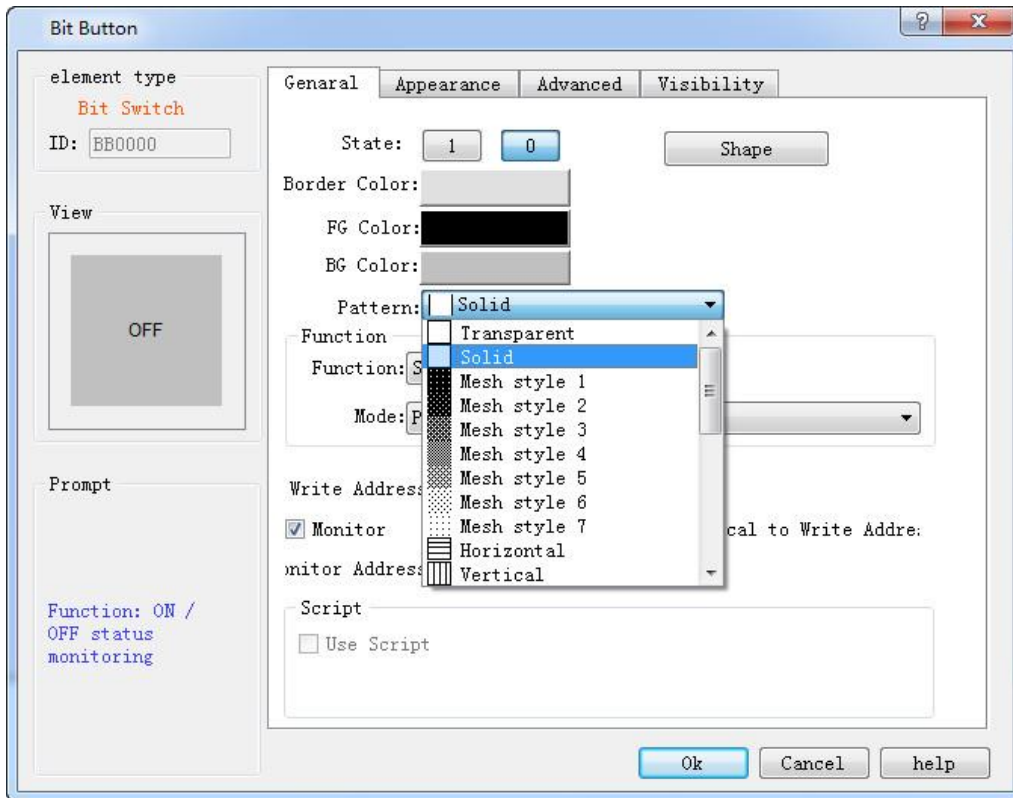

Figure 4-70 Change shape and pattern value

- ◆ Set: If Set function is chosen, after the downloading to HMI, the value of the write-in address may be set to 1 by clicking the bit button. In other words, the write-in address of the device connected will be set to ON status, and the status of 1/ON will be displayed.
- ◆ Reset: If Reset function is chosen, after downloading to HMI, the value of the write-in address may be set to 0 by clicking the bit button. In other words, the write-in address of the device connected will be set to OFF status, and the status of 0/OFF will be displayed.
- ◆ Inching: If Inching function is chosen, either “pressing down being 1” or “pressing down being 0” may be chosen. When “pressing down being 1” is chosen, after downloading to HMI, the value of the write-in address of the device connected is set to 1/ON when the bit button is pressed down, and the status of 1/ON will be displayed; meanwhile, the value of the write-in address of the device connected is set to 0/OFF when the bit button is released, and the status of 0/OFF will be displayed. When “pressing down being 0” is chosen, after download to HMI, the value of the write-in address of the device connected is set to 0/OFF when the bit button is pressed down, and the status of 0/OFF will be displayed; Meanwhile, the value of the write-in address of the device connected is set to 1/ON when the bit button is released, and the status of 1/ON will be displayed.
- ◆ Alternate: When Alternate function is chosen, after the downloading to HMI, if the current status of the bit button is 0/OFF, the value of the write-in address will be set to 1/ON when the bit button is touched, and the status of 1/ON will be displayed; If the current status of the bit button is 1/ON, the value of the write-in address will be set to 0/OFF when the bit button is touched, and the status of 0/OFF will be displayed. The status changes with the times of touching.

- ◆ Write Address: Click the Keyboard button icon after "Write Address" to enter the address. SKTOOL software will distribute corresponding address symbols according to different connected devices. For example, in FX-2N series of MITSUBISHI (Mitsubishi) PLC, X represents the address of input coil; Y represents that of the output coil; M that of the intermediate relay; C that of the counter (switch status display); T that of the timer (switch Status display); D that of the data register; C \* that of the counter (count value); T \* represents that of the timer (count value). Another example is the series of SIEMENS (Siemens) S7-200: I represents the input address; Q on behalf of the output address; M on behalf of the intermediate relay address; V on behalf of the data register address. As shown in Figure 4-71:

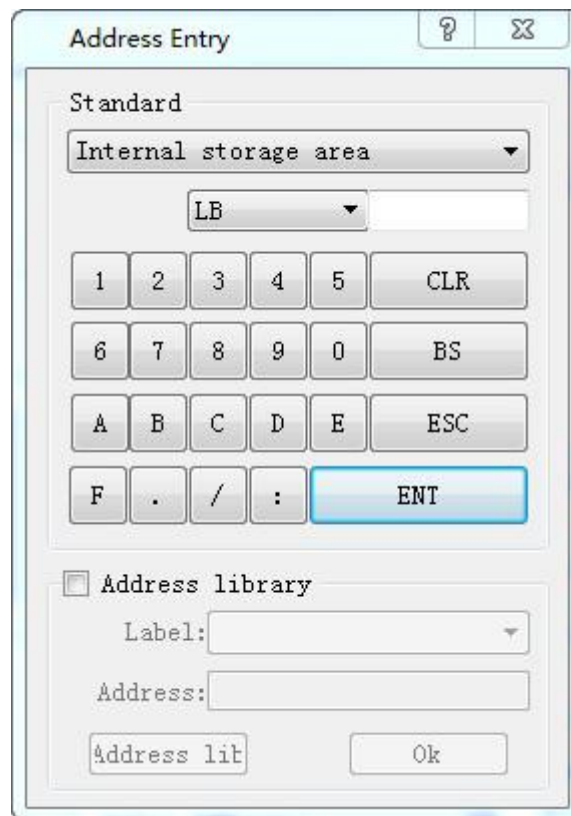

Figure 4-71 Input address

So that engineers can write the current status of this bit button to the address using a different address symbol for PLC or other connected devices. The value of the write address or display address is 0 / OFF when the bit button is in the 0 / OFF state; and the value of the write or display address is 1 / ON when the control is in the state of 1 / ON.

- ◆ Monitor: Select "Monitor" to display the "Monitor Address", indicating that the "bit button" can be used to monitor the value change of "Monitor Address". The value of the Monitor address is 0 / OFF when the bit button is in the 0 / OFF state; and the value of the Monitor address is 1 / ON when the control is in the state of 1 / ON. When "Monitor Address" is chosen, the monitor address and write address can be different. For example, when it selects the Set function, touching this control makes set the write address to 1 / ON; but if the monitor address is at 0 / OFF at this time, the bit button will still display 0 /



OFF state. Generally, users choose "Monitor address identical to Write address" in order to reflect or display directly the state value you write.

- ◆ Macro: Chosen "Use Macro", then it will display a list of macros. User can select a macro to execute when press the bit button. Only compiled macros are displayed in the drop-down list.



When Monitor isn't chosen, the button switch state will not change even if the control is touched.

### Mark

When select the Mark tab, the property of Status 0 Text is displayed, as shown in Figure 4-72:

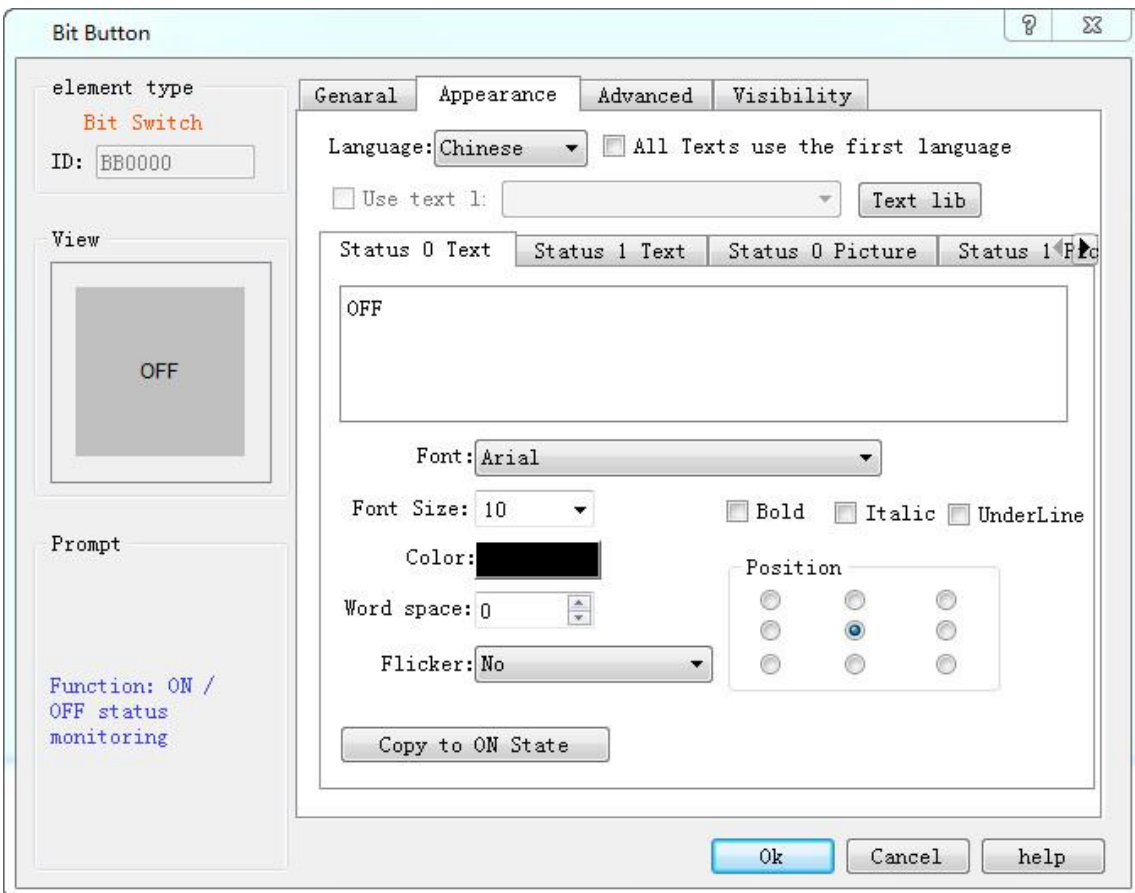

Figure 4-72 Bit Button Label page

The page also has four items, "Status 0 Text", "Status 1 Text", "Status 0 Picture" and "Status 1 Picture".

- Status 0 Text, Status 1 Text: Used to change the font, font size, margin, font color, and position of the state 0 or state 1 text. SKTOOL also provides the copying function, enabling copy one's attributes to another's, which is convenient and timesaving.

- All Texts use the first language: This option is used when it comes to multiple languages ("Language" in the Project Manager). When the total number of languages is greater than 1, you can select this option to make sure that the contents of this control will not switch with the languages.
- Language: This option is used when it comes to multiple languages. Input contents with a different language for multiple languages.(In the Function button, select the 'Switch language' option and which one to switch to; then in the simulation or on the HMI screen, all the controls with text will be presented by the selected language). For different languages, the text content, font and font size can be different, but the color, kerning and position are the same
- Font: Choose the type of text for the text; different languages can choose different fonts.
- Font Size: Choose the font size for the text content; different languages can choose different font sizes..
- Color, Margin, Position: Set the color, Margin, and alignment of the text selected current. When it has more than one language, these options are the same to that of the language 1, and they are invalid in the language setting of others.
- Status 0 Picture, Status 1 Picture: You can add different formats of picture for different states according to various "Picture source". When a picture is chosen, it will be automatically added to the "General" page. If "Fit to Object Size" is selected, the selected image will be the same size as the control.
- Fit to Object Size: If "Fit to Object Size" is selected, the selected image will be the same size as the control; and the Margin and Position options are hidden.
- If you import a picture from an external file, the "Transparency" option appears to make a specified color transparent



When "Flicker" is chosen, the flashing screen is on the ON / OFF status. The default flashing frequency is 1s. If you want to change the frequency, you can double-click the "Project Manager" in the "HMI parameter settings". Select the "Flashing frequency" to change it.

Select the "Advanced" page to display the "Advanced" properties, as shown in Figure 4-73

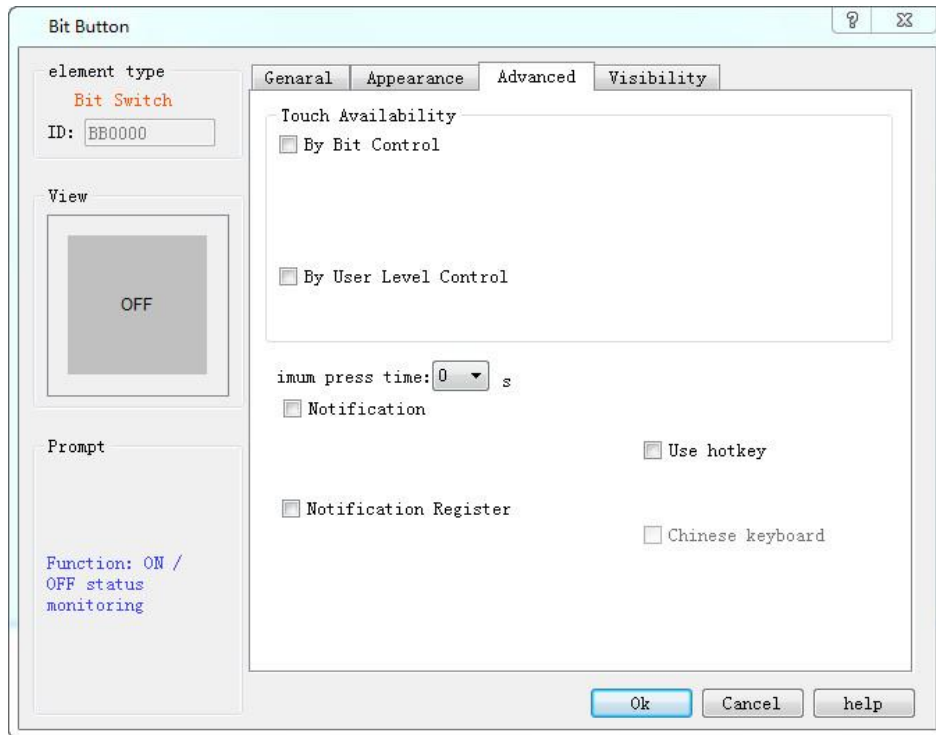

Figure 4-73 Bit Button Advanced page

- Controlled by Bit: "Controlled by Bit" having been chosen, when the "Valid Status" selected is 1, the "Bit Button" can be effectively touched if and only if the value of the "Control Bit" is 1. When the selected "Valid Status" is 0, the "Bit Button" can only be effective if and only if the value of the "Control Bit" is set to 0. Otherwise, the "Bit Button" cannot function no matter how.
- Controlled by User Level: User can select multiple options as needed. After setting, in the simulation or on the HMI screen, the current user is checked whether this user lever has the permission.

For example, if option 2 and 3 are chosen in the Effective Level Controlled in the Advanced Page of the control, and the User Password Setting in the Touch Screen Parameter Setting is as shown in Figure 4-74:

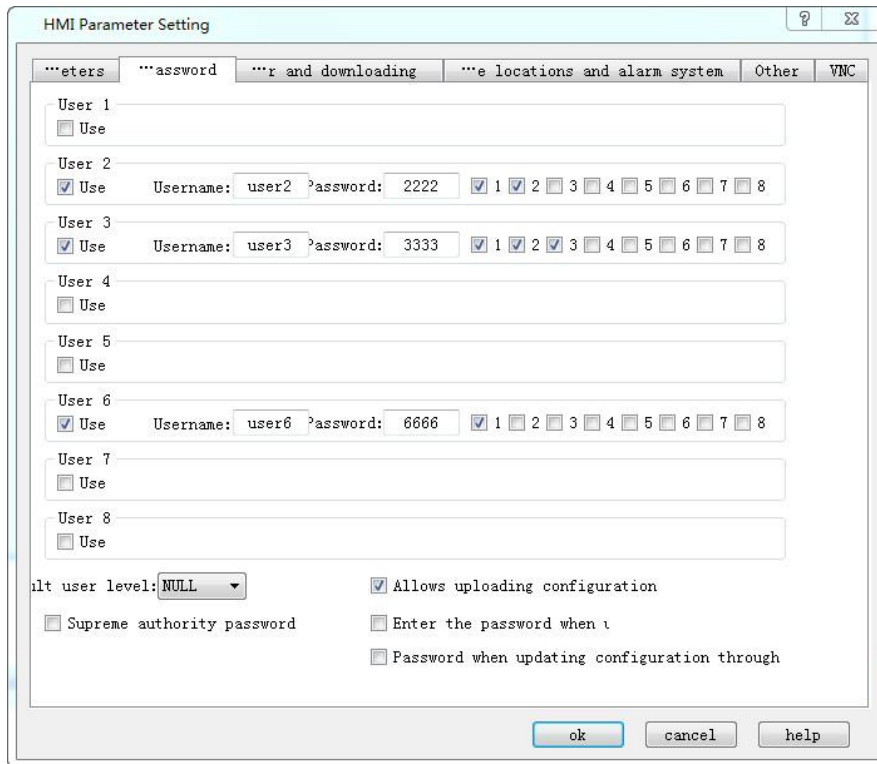
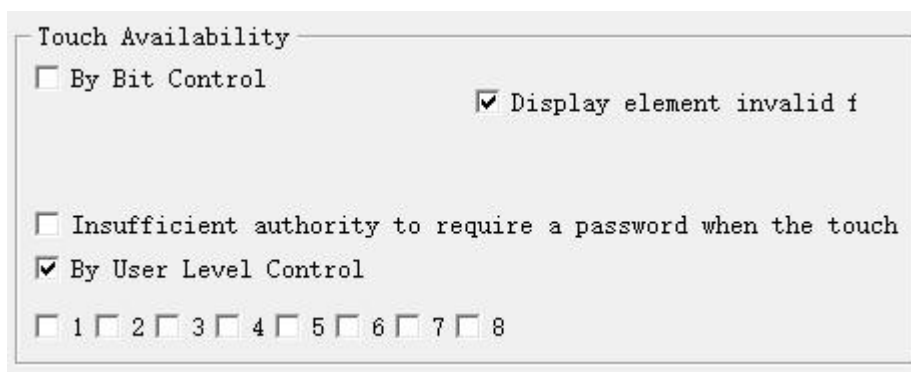

Figure 4-74 User Password Setting in the touch screen parameter setting

If Default User Level is NULL, this control is not touchable, and in this case you can use Change User Level in Function buttons to change the default level. For example, if the password entered by the user is 6666, corresponding to User Level 6, but the user chooses only option 1, not matching option 2 or 3, so the system will prompt that the password is incorrect; When the password entered by the user is 2222 or 3333, as both users have option 2, matching option 2 or 3, the password is valid and this control will be changed to a touchable control. If the Default User Level is user 2 to 3, then both user levels have option 2 to match the touching conditions, and then this control is touchable in simulation or initialized screen; If the Default User Level is user 6, then this user level does not have an option to match the touching conditions, and then this control is not touchable in simulation or initialized screen. The default setting is as shown in figure below:



If select “change the user level is insufficient”, when the user level is not matched, a login interface will pop up so that user can select a matching level and log in again, as shown below:

Touch Availability

By Bit Control

Display element invalid f

Insufficient authority to require a password when the touch :

By User Level Control

1  2  3  4  5  6  7  8

In SKTOOL software, only bit button, drop-down box, ASCII input, function button, ASCII keyboard input, multi-function button, multi-state button, formula selection, screen button, radio button, step button, word button, slider and numeric input controls have this function, and as for their application, it can refer to that of bit button.

- Minimum press time: How many seconds it needs to react after the press in the simulation or on the HMI screen.
- Notification: In the case of that the control can be touched in the simulation or on the HMI screen, click on the control, and enter a value with the pop-up input keyboard; then the state value will be written to the set "Notification Bit" address (1 or 0).
- Notification Register: In the case of that the control can be touched in the simulation or on HMI screen, click on the control, and input a value through the pop-up input keyboard, then the value will be written to the set "notification register address" ( i.e. the value input by user).
- Hotkey: When this function is selected, you can enter a number or character to achieve the same effect as that of pressing, For example, if input 1, click the numeric keypad 1 in the simulation or on HMI screen, or through an external keyboard, it functions similarly.

Use hotkey

1



The default user level is NULL, which is the lowest level. Engineering designers can change the it by selecting the "Change User Level" function in the function button and entering the corresponding password.

Effective touch means actual effect generates when the control is touched, such as the success of the set, reset, inching, alternation. Another example is the numeric input. When user touches the numeric input button, the keyboard will pop up. Meanwhile the numeric input button will not generate a notification effect, since this operation is not written to the address. If you press ESC to exit the keyboard will not produce notice.

It is valid only when you enter a numeric value between the maximum and minimum values on the keyboard and press the ENTER key, then a notification will arise.

Select the "Show" page to display the "Show" property, which is used to set whether the control is displayed or hidden. As shown in Figure 4-75

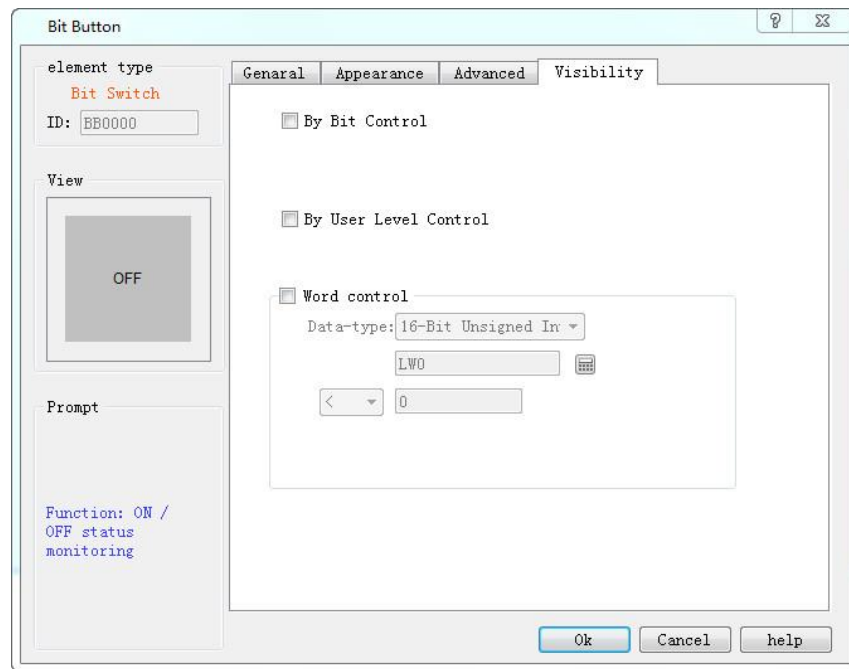

Figure 4-75 Bit Button Visibility page

- Controlled by bit: When this option is checked, if the Effective State is 1, then the Bit Button can be displayed on the touch screen when and only when the value of the Control Bit is 1; If the Effective State is 0, then the Bit Button can be displayed on the touch screen when and only when the value of the Control Bit is 0.
- Controlled by User Level: When User Level Controlled is chosen, the conditions will be the same as those in the User Level Controlled option in Advanced page, and only when such conditions are met the Bit Button can be displayed on the touch screen.
- Word control : Set the judgment condition, and when the register address data satisfies the setting condition, the control displays, otherwise the control is hidden



If neither of these two options is checked, the control will be always displayed on the touch screen.

## 6.5.2 Word Button



Word Button can support operations of Constant, Enter Value, Increasing, Decreasing, Enter Password, Add and Subtract to the data register address of connected device.

To add a word button:

- Select the Word Button icon  on the toolbar, then the following dialog box is displayed, as shown in

Figure 4-76:

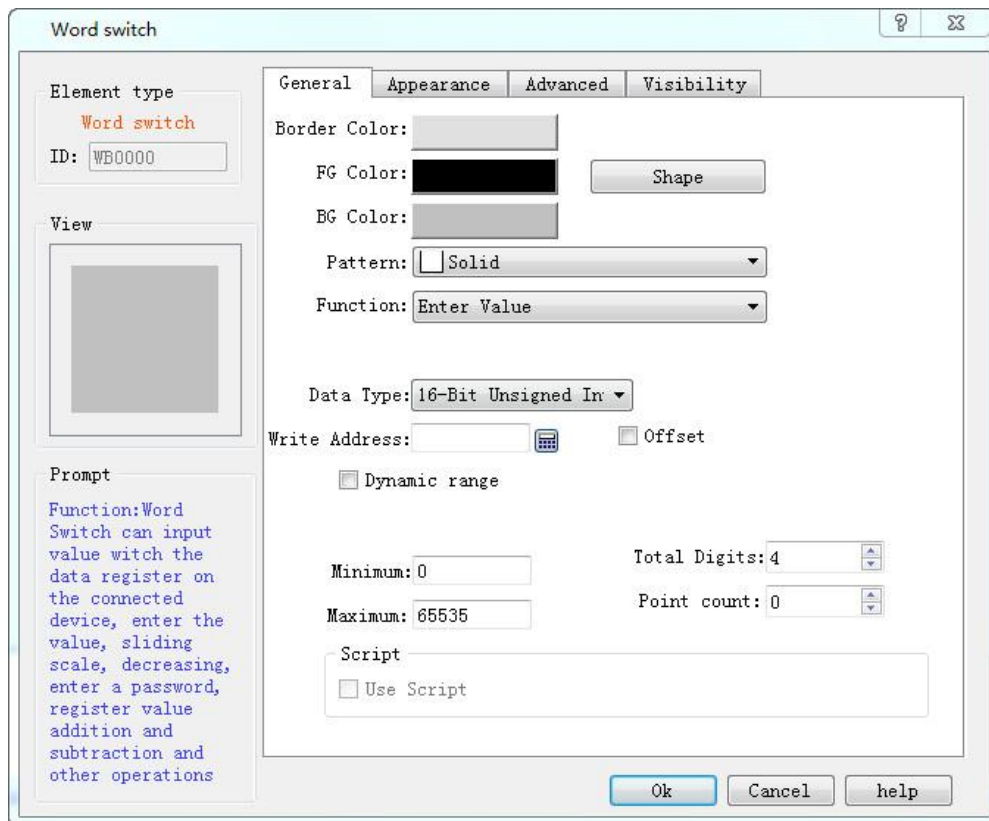

Figure 4-76 Word Button dialog box



The shape, border color, foreground color, background color and pattern can be set with reference to "Bit Button" control.

### Function:

- Set constant: You can choose different data types, SKTOOL software provides a variety of data types: 16/32-bit positive integer, 16/32-bit integer, 16/32-bit BCD positive integer and 32-bit floating point number. Setting a constant is to write the constant value you set to the write address. For example, if

the write address is LW1 and the constant is set to 10, the value of LW1 is set to 10 every time the button is touched, regardless of its current value.

- Enter value: You can select a different data type; input a value between the maximum and minimum with a keyboard popping up after the word button being touched. As shown in Figure 4-77:

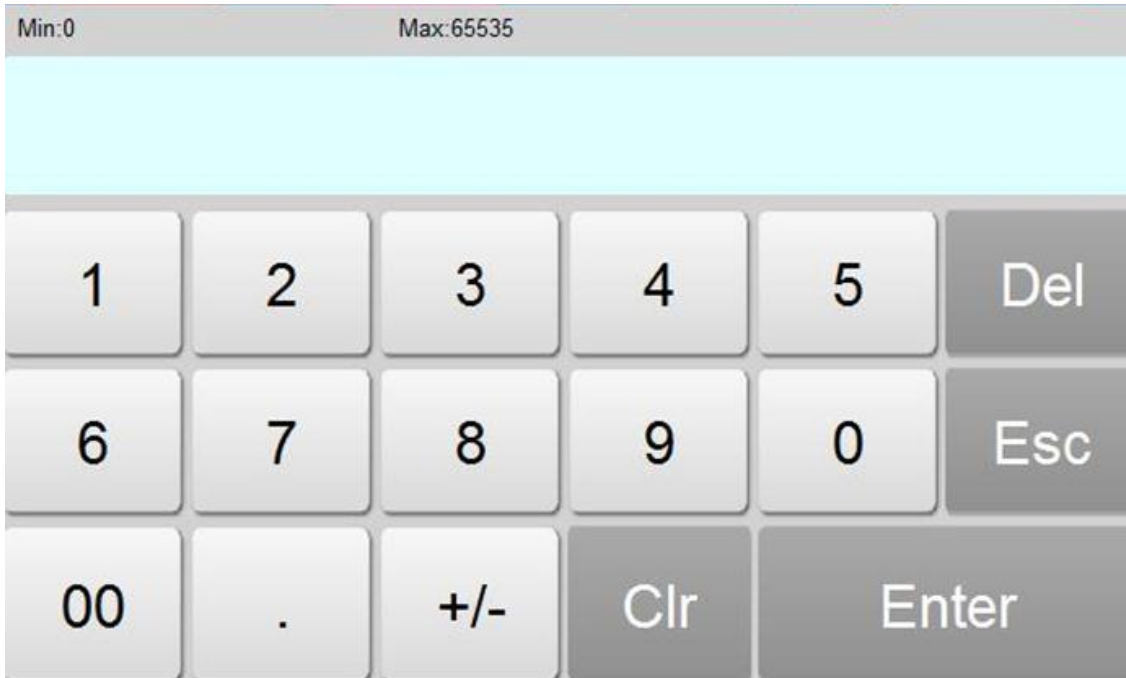

Figure 4-77

- Increasing: When the Delay parameter is 0, its function is the same as that of the Add. If the Delay parameter is not 0, the value of the write address increases by a constant value and is written to the register.
- Decreasing: When "Delay parameter" is 0, this function is the same as that of "Subtract". If "Delay parameter" is not 0, after a certain time, the value written to the address decreases by the constant value and is written to the register.
- Enter Password: Same as the "Enter Value" except that the "Enter Password" function has no option of decimal digits.
- Add: After choosing the data type, writing the address, constant and maximum value, every time you touch the "word button" control, the set value corresponding to the register value will plus the constant value based on the original value. Each time the button is touched, the value written to the address is incremented by a constant; however the value written to the address cannot exceed the maximum value you set. For example, the write address is LW1, the constant is 5, and the maximum value is 65535. Each time you click the Word Button control, the value of LW1 is added to the original value by 5, but the maximum value of LW1 cannot exceed 65535.
- Subtract: After choosing the data type, writing the address, constant and minimum value, every time you touch the "word button" control, the set value corresponding to the register value will minus the constant value based on the original value. Each time the button is touched, the value written to the address is decremented by a constant; however the value written to the address cannot be less than the maximum value you set. For example, the write address is LW1, the constant is 5, and the minimum value is 0. Each time you click the Word Button control, the value of LW1 is subtracted from the original value by 5, but the value of LW1 cannot be less than 0.



- Total number of digits: Number of data including that of decimal points.
- Decimal digits: When the data type is not "32-bit floating point" and there are decimal digits, then the maximum value of the input value should be reduced to 10<sup>n</sup> power. For example: When the selected data type is "32-bit positive integer", and the number of digits is 3, so the user can only enter the value of 0-99999.999.
- Macro: When "Use Macro" is chosen, the macro list is displayed. The user can select a macro to execute when the word button is pressed. Only compiled macros are displayed in the drop-down list.



The "Mark" tab of the "Word Button" is similar to that of the "Bit Button" control. Except that the Word button has no Status Text 1 neither Status Picture 1 because the Word Button has only one state.

If select the 32-bit data type for Word button, the address will occupy the length of two words. For example, write V10 to SIEMENS (Siemens) PLC data register, then the occupied data register address includes V10 and V11. If user still employs other control to monitor V11 value, it will fail to work. Pay attention to the application of 32-bit data type in case of error.

The Advanced and Visibility pages of the Word Button are the same as that of the Bit Button control. You can refer to the Bit Button control and refer to Bit Switch for the use of hotkey.

### 6.5.3 Bit Lamp

The Bit Lamp can be used to monitor the ON / OFF status of bit contact of the connected device and to display it on the HMI screen.

As shown in Figure 4-78 below:

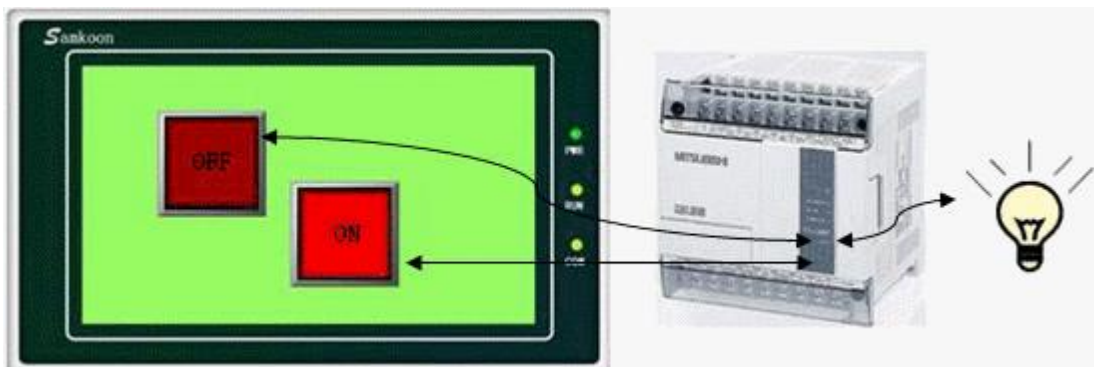



Figure 4-78

Set up a Bit Lamp:

1. Select the Bit Lamp button icon  on the toolbar: The dialog box shown in Figure 4-79 will pop up:

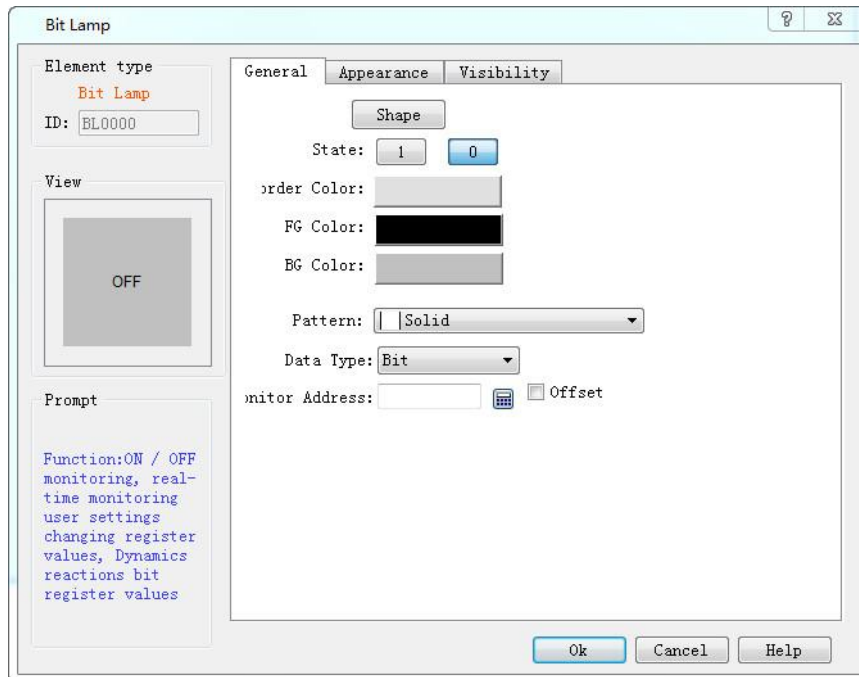

Figure 4-79 Bit Lamp dialog box

- Data Type: The drop-down box has three options, namely: Bit, Word Bit and Double-word Bit. If select "Bit", the Monitor (read) address is Double-word Bit means a double word address.
- Bit Number: When the chosen data type is "Word Bit" or "Double-word Bit", the value of the monitor address (status of ON/OFF) is determined by the bit number value. It is from 0 to 15 for Word Bit and 0 to 31 for Double-word Bit.

For example, when "Word Bit" is selected, the monitor address is LW1 with a value of 23, if the bit number is 3, the state of this address value is 0 because the binary number of 23 is 10111 whose 3rd number from right to left is 0.



Note: Refer to Bit Button control for Shape, Border color, Foreground color, Background color and Pattern.

2. In the "General" Property dialog box of the bit lamp, choose an address to be monitored by this indicator. Through the settings in "Mark", you can set contents and pictures to be displayed and also choose whether to blink.



Note: The "Mark" page of the "Bit Lamp" is the same as that of the "Bit Button" which you can refer to.

3. To reset the properties of this indicator, double-click it to reset it in the property dialog box.



Note: The Visibility page of the Bit Lamp is the same as that of the Bit Button control that you can refer to.

After the properties set up, click "OK" to add the control in the view area (i.e., the screen)

## 6.5.4 Screen button



Screen button is designed for screen switching, changing the user level, pop-up window and other operations. After being set, it can make a screen/ window jump to a certain screen / window while you can also decide whether to change the user level at the same time.

- Click the icon button  on the toolbar to bring up the dialog box , as shown in Figure 4-80.

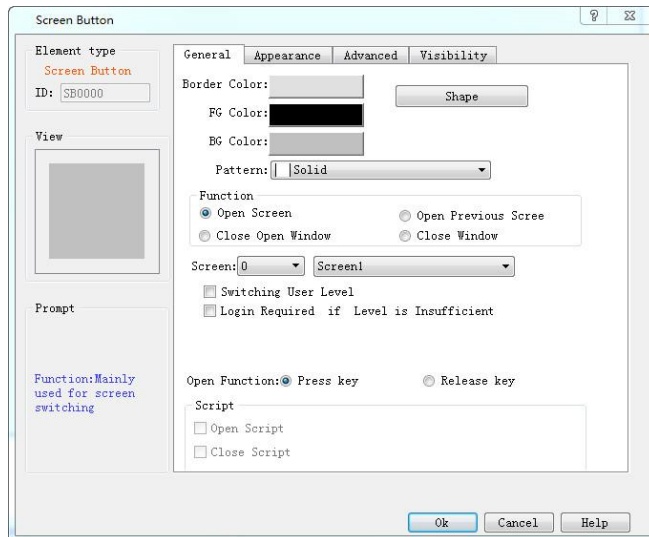

Figure 4-80 Screen Button Dialog Box



Shape, border color, foreground color, background color and pattern settings can be used with reference to "Bit Button".

**Function modules:**

- Open Screen: It allows users to jump to the selected screen by clicking the button. This function can be employed on a screen or in a window.
- Open Previous Screen: It allows users to jump to the previous screen of this page by clicking the button. This function can only be used in the screen page.
- Close Open Screen: This function can only be used in the window page. It allows closing the current window and opening another window or screening.
- Close Screen: This function can only be used in the window page. This function allows closing the current window page.

**Switch user level:**

- Logout: Restore the current user level to the default user level
- Specified User Level: Change the current user level to the specified user level

**Open function:**

- Press: When the user presses the mouse, it executes the screen switching function.
- Release: When the user releases the mouse, it executes the screen switching function.

**Login required if level is insufficient:**

If the user has selected the " Controlled by User Level" option on the "Advanced" page of the "Screen Button" dialog box, and has changed the "Effective Lowest Level", then the screen control is only valid if the current user level is higher than or equal to the user- If the current user level is less than the effective minimum level set by the user, the password input box will pop up when the user touches the screen control on the touch screen, as shown in Figure 4-81:

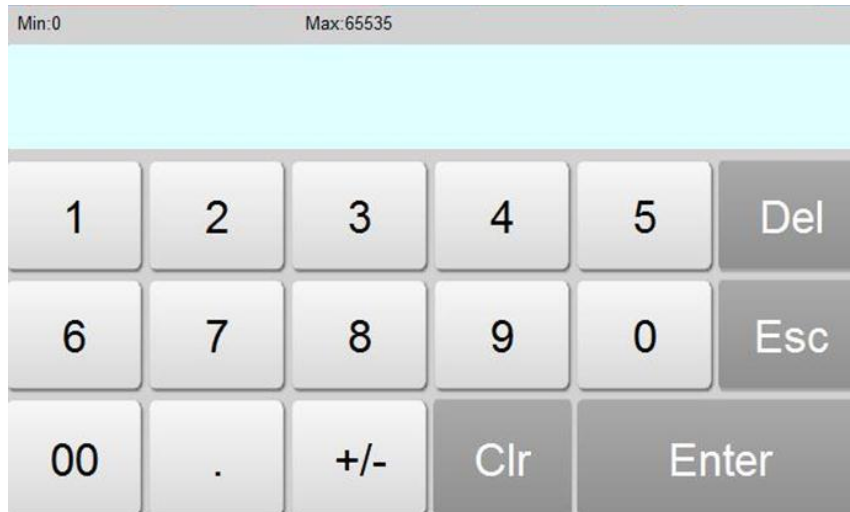

Figure 4-81 Password input keyboard

This screen can only be opened when the password entered by the user is higher than that set by the user, and the current user level is decided by the level password just entered by the user.

**Macros:**

"Open macros" displays a list of macros. The user can select one to execute when press the button. Only compiled macros can be displayed in the drop-down list.



The "Label" page of the Screen Button is similar to that of the "Bit Button" control. Because the Screen Button has only one state, its Label page only has Status 1 Text and Status 1 Picture. Apart from that, the functions are the same.

The "Advanced" and "Visibility" pages of the "Screen Buttons" are the same as those of the "Bit Button" control, which can be used with reference to the Bit Button.

After setting all the properties, click "OK" and the mouse cursor will turn into a cross. Left click in the view area to add the control to the screen.

## 6.5.5 Function Button



Function Button is an essential control in HMI; with the Function button you can achieve a variety of functions

easily and quickly. Click  to open the property dialog box of Function Button, as shown in Figure 4-82:

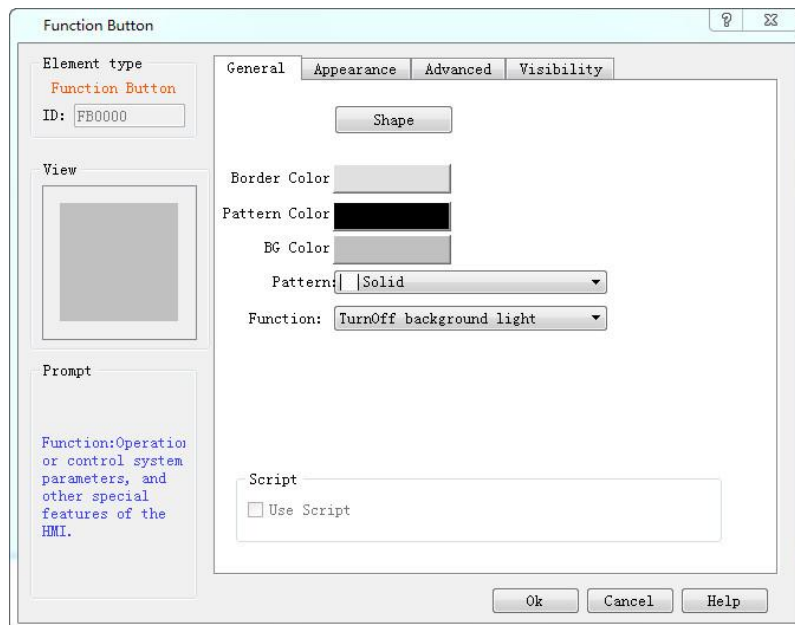

Figure 4-82 Function Button dialog box



Note: Refer to Bit Button control for Shape, Border color, Foreground color, Background color and Pattern.

### 1. Turn off Background light

Choose the function of Turn off the background light. Then click the button on the screen to turn off it while HMI will still works properly. To turn on the backlight, simply touch anywhere on the touch screen.

### 2. Confirm Alarm

Choose the function of Confirm the alarm. Then you can confirm the selected alarm by clicking the button

### 3. Restart

---

If the function button is set to System Restart, then the touch screen will be restarted by touching this button.

#### **4. Set screen saver timeout**

If the function button is set to Set Screen Saver Timeout, then a window will pop up for setting of screen saver timeout after touching this button.

#### **5. Write recipe to the PLC**

Choose this function to transmit recipe to the PLC. Click this button on the touch screen to transmit the recipe saved in the current HMI to the PLC or corresponding continuous data register of other connected devices. (The address is the write address set by engineers when set up a recipe with the software.)

#### **6. Read recipe from the PLC**

Choose this function to read recipe from the PLC. Click this button on the touch screen to read the recipe data from the PLC or corresponding continuous data register of other connected devices. (The address is the write address set by engineers when set up a recipe with the software.)

#### **7. Set the date and time**

Choose this function to set the time and date; click the button on the touch screen to set the inner time and date.

#### **8. Clear Alarm**

Choose this function to clear the alarm; click the button on the touch screen to clear the selected and confirmed alarm.

#### **9. Previous recipe**

Choose this function of the Previous Recipe to open the previous recipe of the current one after clicking this button. If the current recipe is the first one or the total number of recipe is 1, this operation does not change recipe parameters.

#### **10. The latter recipe**

Choose this function of the Latter Recipe to open the latter recipe of the current one after clicking this button. If the current recipe is the last one or the total number of recipe is 1, this operation does not change recipe parameters.

#### **11. Save the current recipe**

Choose this function for saving the current recipe by clicking the button on the touch screen to save the recipe data from corresponding continuous data register of the PLC or other connected device, which is set

---

when engineers set up the recipe with the software.

## **12. Screenshots**

Set the function button function as Screenshot; click this button to intercept the current screen as a picture saved in the user-specified location. The address of Picture name can be input using ASCII Input, the Picture name cannot consist of : # ¥ % & \* - + < > etc. And the length of the name must be 20 or shorter than 20.

## **13. System parameters**

Set the system parameter of the function button. Click it on HMI to open the system parameter setting screen where you can modify settings, such as system time, screen saver time, background light contrast and so on.

## **14. Log on**

Choose the function of Log on, then when user clicks this button, a login interface will pop up. After choosing the User Name, a keyboard will pop up with which user inputs a password to achieve an access permission.

## **15. Cancel user login**

Choose the function of cancel a user's login; click this button on the touch screen to log out and cancel the current user's privilege so that the user's level becomes the lowest.

## **16. Alarm Sound (ON / OFF)**

Choose the function of Alarm Sound ON / OFF to make a sound when it occurs an alarm. You can set the function button to enable or disable this function. If the current state is on, the alarm sound will be shielded after user clicking this button, and vice versa

## **17. Touch sound (ON / OFF)**

Set the function button to Touch Sound Switch, then the touch sound may be turned on/off by touching this button. If there is touch sound at present, the touch sound will be turned off after touching this button, and vice versa.

## **18. Clear all historical data**

The history data stored in HMI will be cleared.

## **19. Clear the historical alarm**

The history alarm saved in HMI is cleared.

## **20. HMI protection unlock**

Enter the password to deactivate the HMI protection.



---

### **21. Recipe Read & Save**

Read and save the recipe.

### **22. Alternate function**

Only as back-up function, it does not perform any operation.

### **23. Reload recipe**

Reload the recipe data in flash to the corresponding RWI address.

### **24. Switch languages**

Switch text contents of all the controls to that of another specified language

### **25. Print Screen via a serial printer**

Print the set screen through a serial printer. Connection setting of the printer driver is under the "HMI Parameter settings" -> "Printer and Download settings", in the left frame of the software interface.

### **26. Slave devices IP config**

This function requires the "Extended Mode" that can be set in the "Communication Port Property". The application of Ethernet communications for multi-machine needs to add a station number and the register address controlling the station number in front of the corresponding control. When the project in HMI is running, click on the function control, and the station number set by user will be shown in the "IP config" dialog box; then set the corresponding IP parameters of station number to achieve multi-machine Ethernet communication.

### **27. Function set of DIP switch 1 and 3**

Functions of DIP switch 1 and 3 on the hardware when they are in ON state, mainly consisting of IP setting, system time setting and backlight parameters. After the setting, click OK to restart.

### **28. HMI delay solution lock**

When HMI protects the -> advanced -> delay function, the button is needed to hit the button at the touch screen, and the delay function will take effect

### **29. Touch calibration**

Recalibrate current touch screen coordinates

Use Macro: Selecting "Use macro" will bring up a list of macros and users can choose one to execute when

the function is executed. Only compiled macros are displayed in the drop-down list.



Note: After jumping to the system screen, the system will close the current project; when return from the system screen, it will restart the project, and enter the start screen of project settings.

Note: The "Mark" page of Function button is similar to that of the "Bit Button" control which you can refer to. Except that the Mark page of Function button has no Status Text 1 neither Status Picture 1 because it has only one state.

Note: The Advanced and Visibility pages of the Function Button are the same as that of the Bit Button control. You can refer to the Bit Button control and refer to Bit Switch for the use of hotkey.

Note: Operations of Previous recipe, later recipe, save recipe, read & save recipe are only valid to the current recipe group. If you still want to operate, set the LW61141 group then.

Note: Clear history data means all historical data groups are cleared.

After setting all the properties, click "OK" to add the control button to the view area (i.e., the screen)

## 6.5.6 Multi-state Button



Functions between Multi-state button and Multi-state indicator lamp are basically the same, while the only difference is that multi-state button supports value input, rather than simple function of indicating. Specific operation is as follows:



Click the button icon on the toolbar to display the dialog box shown in Figure 4-87.

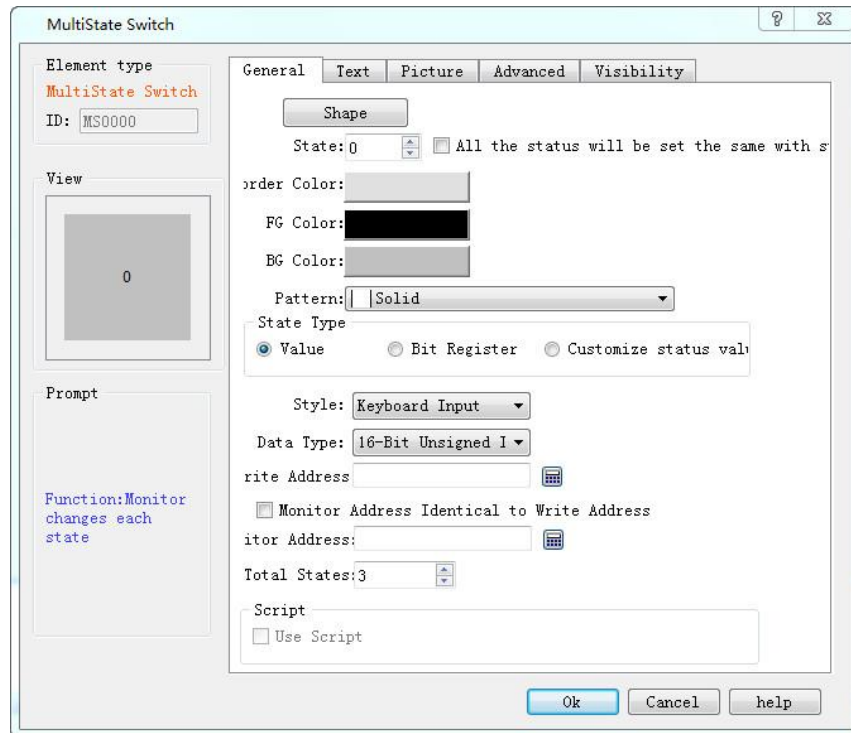

Figure 4-87 Multi-state button dialog box

- State: User can change the state value, as well as the border color, foreground color, background color and pattern of the control in different states
- State type: (assuming the input value is n)
  - Value: The value written is a number from zero to the total number of states.
  - Register bit: the value written is nth power of 2.

E.g:

Select "Value" for State Type, "Keyboard Input" for Mode and LW3 for Write Address and select the option of "Monitor Address Identical to Write Address", the total number of states 8. After that, click OK to add the control to the screen, then save the project.

In the simulation or screen, click on the control, and then an input keyboard pops up where user can enter a state value. Assuming that the input value is 3, then the value written to the register LW3 is the 3rd power of 2, which shows the text in the state 3 (the text in state 3 of this control in the Text page). Conversely, when the value entered for the LW3 address is 8, the control displays the text content of the state 3. When the value of the LW3 address input is 5, the control does not display any status.

- Customize Status Value: When select this option, a "Define Status Value..." button appears, as shown in Figure 4-88:

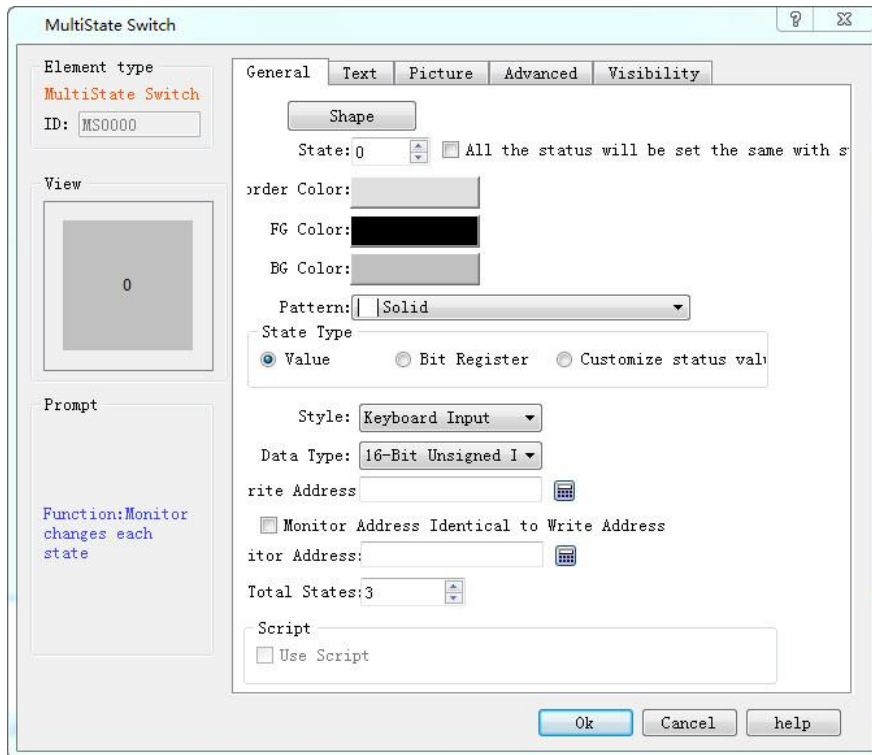

Figure 4-88 Multi-state button select Customize Status Value

Click "Define status value..." button, it will pop up a "Customize status value" dialog interface, as shown in Figure 4-89:

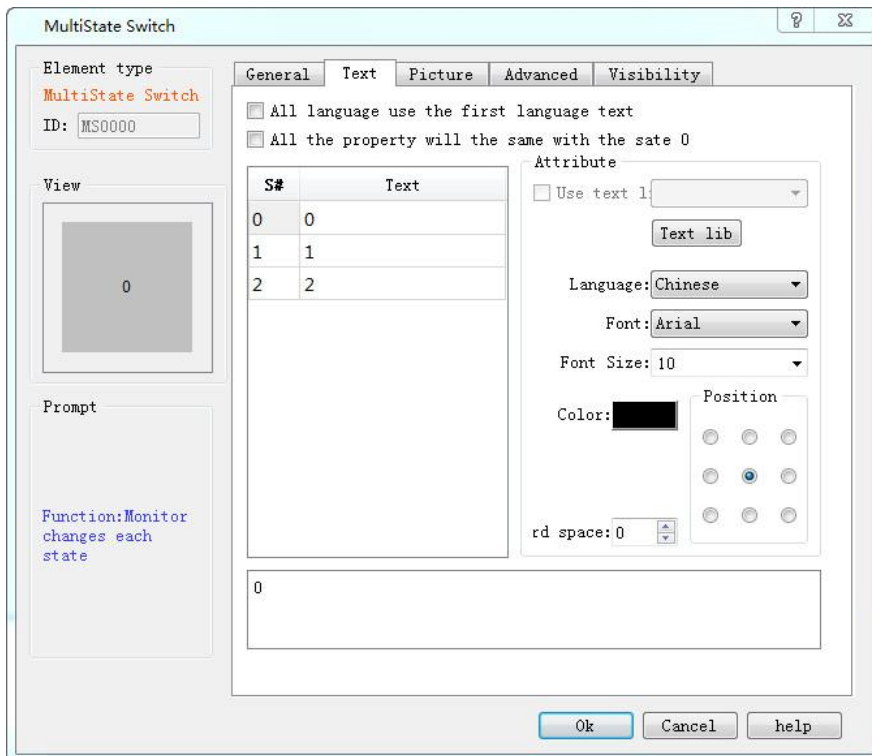

Figure 4-89 Define status value dialog box

In this dialog box, the "S #" column is the current status column. After selecting a row, the corresponding

value to "S#" in that row indicates the current status value; double-click to enter the value in the current state.

For example, Select "Customize status value" for State Type, "Keyboard Input" for Mode, and LW3 for Write Address and select the option of "Monitor Address Identical to Write Address", the total number of states is 8. After that, click OK to add the control to the screen, then save the project. In the simulation or screen, click on the control, and then an input keyboard pops up where user can enter a state value. Assuming that the input value is 1, then the value written to the register LW3 is 22, which shows the text in the state 1 (the text in state 1 of this control in the Text page). Conversely, when the value entered for the LW3 address is 33, the control displays the text content of the state 2. When the value of the LW3 address input is 2, the control does not display any status.

- Mode: Provide six function options: "Keyboard Input", "Output constant", "Increase", "Decrease", "Loopback increase " and "Loopback decrease ".
- Keyboard input: Three options in the "State Type" can be selected. In the simulation or screen, when click the control, it will pop up a keyboard for user to enter the value, as shown in Figure 4-90:

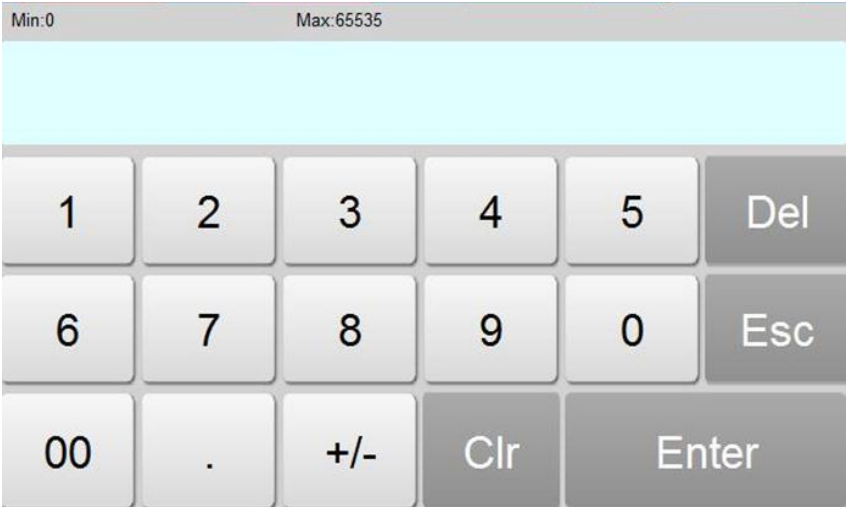

Figure 4-90 Keyboard

- Output constant: Only the "Value" option can be selected among the three function options in the "State Type". After selecting this option, a "constant" box will show for constant setting. In the simulation or screen, if click on the control, the value written is the set constant value
- Increase: Only the "Value" option can be selected among the three function options in the "State Type". In the simulation or screen, when click on the control, each click means the number of state plus 1; it stops increasing in case of beyond the total number of state.

- Decrease: Only the "Value" option can be selected among the three function options in the "State Type". In the simulation or screen, when click on the control, each click means the number of state minus 1; it stops decreasing in case of beyond the total number of state.
  - Loopback increase: Only the "Value" option can be selected among the three function options in the "State Type". In the simulation or screen, when click on the control, each click means the number of state plus 1; it returns to state 0 if beyond the total number of state.
  - Loopback decrease: Only the "Value" option can be selected among the three function options in the "State Type". In the simulation or screen, when click the control, each click means the number of state minus 1, it will return to the maximum state in case of beyond the total number of state.
- Data Type: The data type of the write address and monitor (read) address
  - Monitor address: Read address whose value is to read the state value and reflect the current state on the control.
  - Total number of states: the maximum number of states
  - Use Macro: If this option is selected, when click on the control in the simulation or screen, the macro selected by the user is executed in this case.



Note: Shape, border color, foreground color, background color and pattern can be used with reference to "Bit button" control.

Note: Refer to "Multi-state indicator lamp" control for "Text" and "Picture" pages.

Note: The "Advanced" and "Appearance" pages are referred to the "Bit Button" control. Specific hot keys can be used to refer to the bit switch.

After setting the properties, click "OK" to add the control in the view area (that is, the screen)

## 6.5.7 Multi-state Indicator Lamp

---

The Multi-state indicator lamp control is mainly used to display different states according to the value of the monitor address. Up to 32 states can be displayed.

Click the Multi-state indicator button  on the toolbar to bring up the dialog box as shown in Figure 4-83.

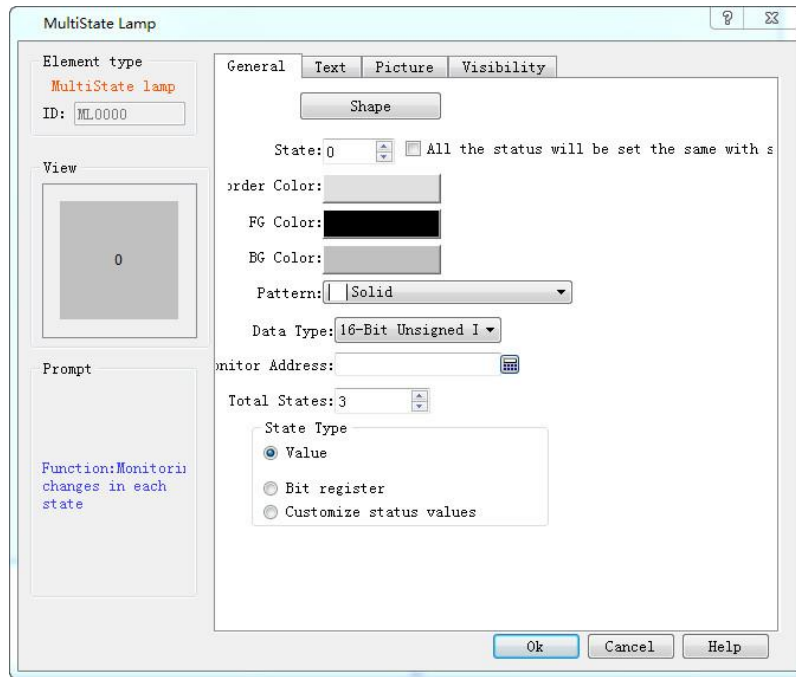

Figure 4-83 Multi-state Indicator Lamp dialog box

1. General:

- State: User can change the status value in order to modify the border color, foreground color, background color and pattern of the control in different states
- State Type: (Assuming the user input value is n)
  - Value: the written value is from zero to the number of total states minus 1.
  - Register Bit: The written value is the n power of 2.

E.g.:

The monitor (read) address is LW3, then the total state number is 8. After, click OK to add the control to the screen; then add a numerical input control on the screen; set the write address and monitor address to LW3; finally save the project.

In the simulation or on the screen, user clicks on the numeric input control, and input a preferred state value through the input keyboard. If the input value is 2, the value of the monitoring (reading) address is 1, the control shows the text in the state of 1 (the text content in state 1 of the control in the Text page); correspondingly, when the value entered for the LW3 address is 8, the control will display the text content of state 3. If a value of 3 is input to the LW3 address, the multi-state indicator does not switch to any state.

- Customize status value: When user selects this option, a "Defined status value" button appears. Click it to bring up "Customize status value" dialog interface, as shown in Figure 4-84:

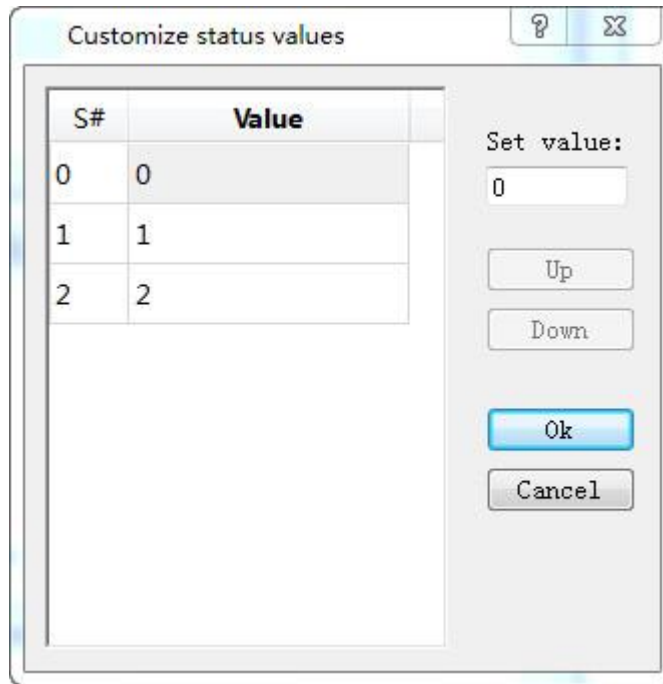

Figure 4-84 User-defined state value dialog box

In this dialog box, the "S #" column is the current status column, that is, the selected value in it indicates the current status value; double-click a Value to enter the value in the current state that you want to write.

For example: The monitor (read) address is LW3, then the total state number is 8. After, click OK to add the control to the screen; then add a numerical input control on the screen; set the write address and monitor address to LW3; finally save the project.

In the simulation or on the screen, user clicks on the numeric input control, and input a preferred state value through the input keyboard. If the input value is 1, the value of the monitoring (reading) address is 1, the control shows the text in the state of 1 (the text content in state 1 of the control in the Text page); correspondingly, when the value entered for the LW3 address is 33, the control will display the text content of state 2. If a value of 2 is input to the LW3 address, the multi-state indicator does not switch to any state.



- Data Type: The data type of the write address and monitor (read) address
- Monitor address: The read address, which is a status value to be read, and then reflects the current state selected by user in the control.
- Total states: Users can set the total number of states according to individual need, which can be up to 32 states, that is from state 0 to state 31.

For example, selecting a data type of 16-bit positive integer, a total number of states of 32, when the data value stored in the monitor address is 0, the Multi-state indicator shows the text and the corresponding picture of the state 0; if the data value is 5, the Multi-state indicator will show the text and the corresponding picture of the state 5;. When the value is 60, the Multi-state indicator will still display the message of the State 31, because the total number of states up to 32 states.



Note: Shape, Border color, Foreground color, Background color and Pattern can be used with reference to that of "Bit Button" control.

Note: When "Multi-state indicator lamp" selects the 32-bit data type, the stored address occupies 2 words. For example, when write data to the SIEMENS PLC's data register, and the address written is V10 , then the occupied data register address includes V10 and V11; if users also use other controls to monitor the value of V11, an error will appear. Users should pay attention to the use of 32-bit data types in case of Note data and address errors.

Note : The data category must be consistent with the data to be indicated.

## 2. Text:

Click the "Text" tab of the Multi-State Indicator Property box to display the text property settings screen as shown in Figure 4-85 below:

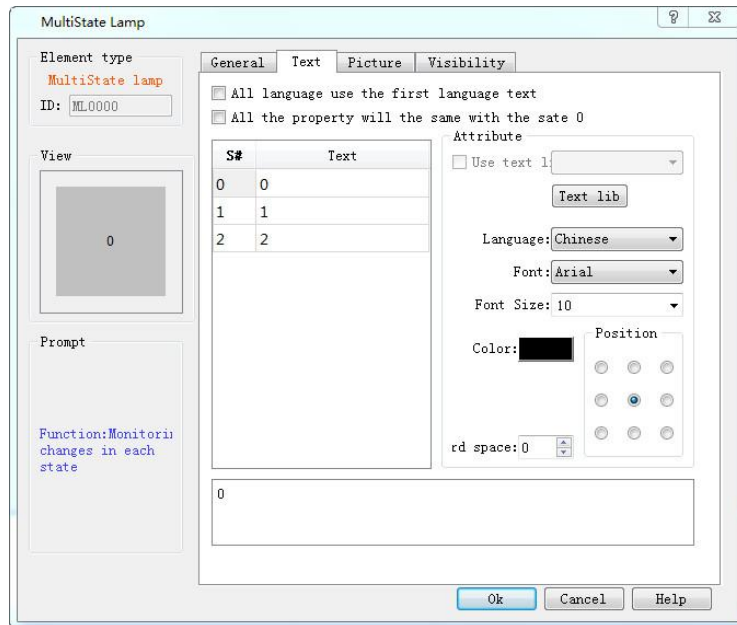

Figure 4-85 Multi-state indicator text page

All languages use the first language text: This option is employed when dealing with multiple languages, that is, in the "Language" in the Project Manager, the total number of languages selected is greater than 1; in this case, the control text does not change with the switch of language.

- Language: This option is used when dealing with multiple languages. Select a different language, you can enter different text contents in different states, in order to achieve the multi-language. (In the function button, select the 'Switch language' option, and the language to switch to; in the simulation or screen, click this button, and then all the screen with text control will switch to that with text content of the specified language). For different languages, text content, font and font size can be different, but the color, kerning and position are the same.
- Font: You can choose the type of text for the input text; different states can choose different fonts, and different languages can choose different fonts.
- Font Size: You can choose the font size for the input text content; different states can choose different font sizes; different languages can also choose different font sizes.
- Color, Kerning, Position: Set the color, kerning, and alignment of the selected text. When you choose a language other than Language 1 in the Text page when the total number of languages selected in the Project Manager is greater than 1, the three functions: color, kerning and position are invalid because they are the same as the language 1.

### 3. Picture:

Click the Picture tab of the Multi-State Indicator Property box to display the attribute settings as shown in Figure 4-86.

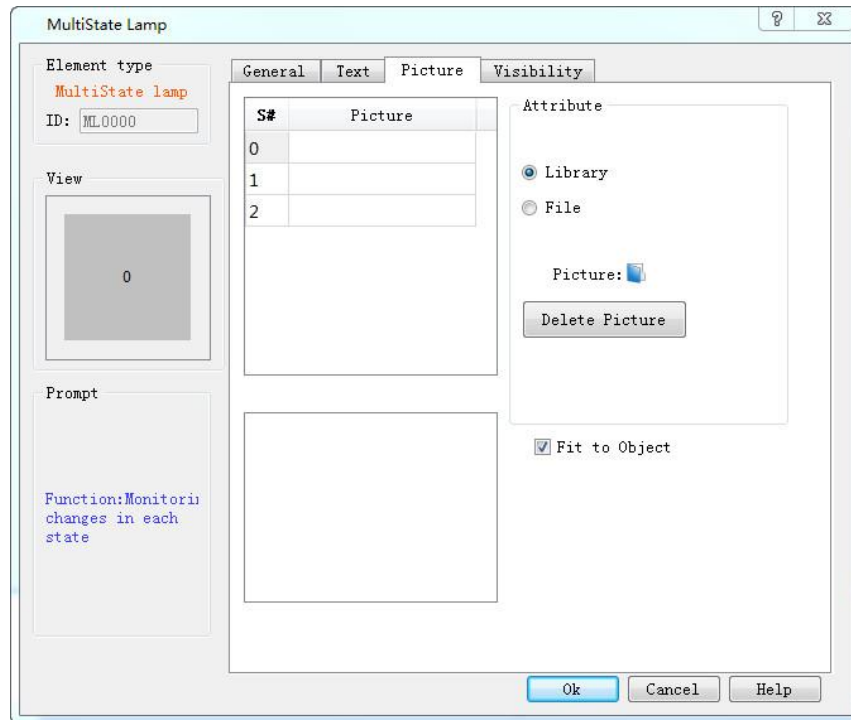

Figure 4-86 Multi-state indicator lamp picture page

This page is mainly employed to load pictures for different states. Picture of each state is empty by default while it can be changed according to personal need.

- Steps are as follows: Select the item in the list box whose picture needs to be changed, then choose the right picture either in system library or through save path on Windows. So when click on different status, corresponding pictures will be loaded below. In addition, user can also decide whether to fit to Object: if not, the margin and position of the control can also be modified, so as to beautify it.
- Fit to Object: When this is selected, the size of the graphic is the same as that of the controls on the General page while the Margin and Position options are hidden, otherwise they appear.

If import a picture from an external file, the "Transparent" option will display for use. This function is meant to make a specified color transparent



Note: Refer to "Bit button" control for Visibility page.

After setting all the properties, click "OK" and then add the control in the screen area

## 6.5.8 Numerical Display

Numeric display control is a commonly used control displaying values in data register stored in PLC or other

connected devices, such as speed, current, pressure and so on.

Select the display icon  in the toolbar, and then the system will bring up a dialog box. As shown in Figure 4-91:

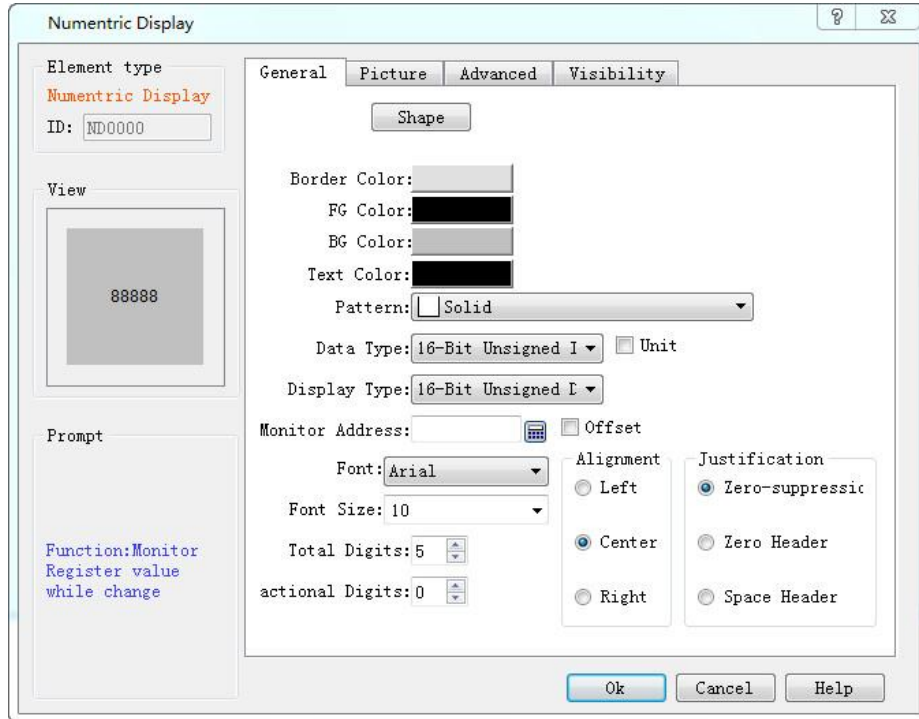

Figure 4-91 Numeric Display dialog box

In this dialog box, you can set the value saved in data register of PLC or other connected devices, such as the display digits, the decimal place, and font size, color, alignment and adjustment of text control.

- Data type: Users can choose different data categories according to the value of the register address to be monitored.
- Display Type: Users can choose different display categories according to project needs.
- Monitor address: Read address. The control is applied to display the data; the monitor address is the data register address carrying data to be displayed in PLC or other connected devices.
- Decimal Place: Display the number of decimal places for the data.
- Font: Choose a general font or digital font.
- Font size: Choose the size of the displayed font as needed.
- Alignment: The default is Center.
- Left: The numerical value displayed is in the left part of the display area.
- Center: The numerical value displayed is at the center of the display area.
- Right: The numerical value displayed is in the right part of the display area.
- Justification: The default is zero-suppression.

- Zero-suppression: Zero in front of the significant figure is hidden. If the value of the monitor address is 00123, a 16-bit positive integer, then the value displayed in the display box is 123.
- Zero Header: Display the leading zero of the effective number of bits. If the value of the monitor address is 00123, a 16-bit positive integer, then the value displayed in the display box is 00123.
- Space Header: Display the space instead of 0 in front of the significant digit. If the value of the monitor address is 00123, a 16-bit positive integer, then the value displayed in the display box is 123.
- Text Color: The font color of the data displayed;



Note: Shape, border color, foreground color, background color and style can be used with reference to "Bit button" control.

Note: Double-click the data display box to reset the contents and properties of the data display. When the control functions in the HMI, an on-screen keyboard will pop up, giving an access to the data input for user.

Note: The number of decimal place affects the data display. When the selected data type is 16/32-bit positive integer, 16/32-bit integer, and then the displayed value is acquired by offsetting the decimal point of return value by the set number of digits. If the value 212 is returned and the number of decimal places is 2, then 2.12 is displayed. If the selected data type is a 32-bit floating-point number, the value has no offset; but only the fractional decimal places are displayed. If the value 2.123 is returned and the scale is set to 2, only 2.12 is displayed.

Note: Total number of bits means the sum of the length of the integer part and the fraction part. If the integer length of the displayed value is greater than that of the integer part, the length of the displayed integer will be that of the actual value. For example, for the value 2123, the length of value is 2, and number of decimal place is 1, then it will display 212.3.

The Advanced page of Numeric display contains powerful functions, including Scaling and Range Display, as shown in Figure 4-92:

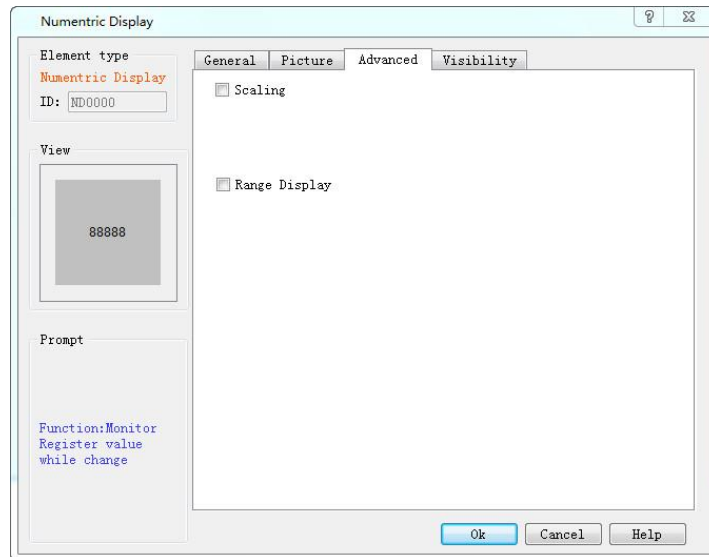

Figure 4-92 Numeric Display Advanced page

- **Scaling:** When this option is selected, the data displayed by the numeric display control is:  $\text{Monitor (Read) Address Value} \times \text{Gain} + \text{Offset}$
- **Display Range:** When this option is selected, user can set the lower and higher limit values as well as the low and high-level background color according to the needs. The address value monitored (read) by the control will be represented by different color patterns in the user-set lower and higher limit values.
- **Variable range:** the values of "Lower Limit" and "Higher Limit" are dynamically changed, depending on the address entered by the user
- **Lower limit:** Set the lower limit of the display. When the number displayed is lower than this limit, the background color will be the color set in Low Level Background Color.
- **Higher limit:** Set the higher limit of the display. When the number displayed is higher than this limit, the background color will be the color set in High Level Background Color.

For example, when you set the background color and text color in the General page and select the Range display color as shown in Figure 4-93:

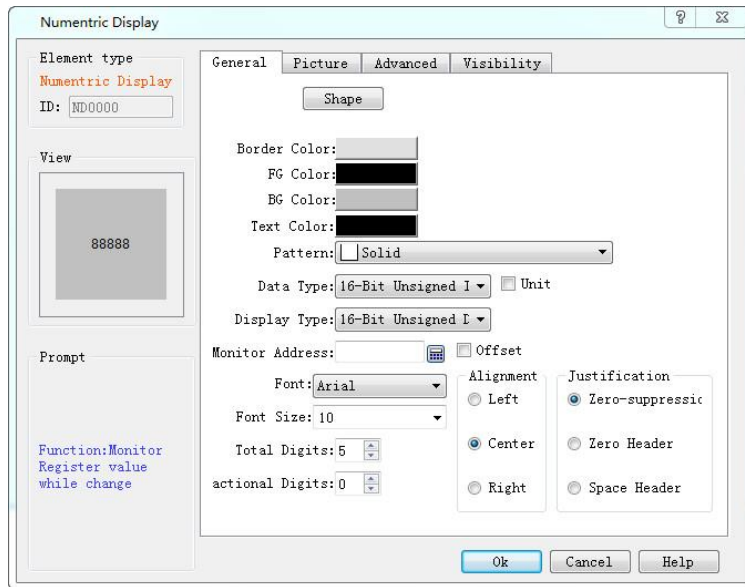

Figure 4-93 Range Display Property Settings

When the value of the monitored address changes, the text and background of the numeric display change accordingly, as shown in Figure 4-94:



Figure 4-94 An example of numeric display



Note: Refer to the use of "Bit button" control for the Visibility page.

Note: When the 32-bit data type is selected, the stored address occupies 2 words. For example, when write data to the SIEMENS PLC's data register, and the address written is V10 , then the occupied data register address includes V10 and V11; if users also use other controls to monitor the value of V11, an error will appear. Users should pay attention to the use of 32-bit data types in case of Note data and address errors.

After the setting, click "OK" to add the control to the view area (that is, the screen)

## 6.5.9 Numerical Input



Numeric input is the most commonly used control, almost essential for all of the process control processes. It can input, display and store the value in the data register of the PLC or other connected devices, such as speed, current, pressure and so on.

Functions of Numeric input and numerical display are basically the same, and the only difference is that the numerical input can enter values to the data register of PLC or other connected devices, but not just display the value.

Specific operations to create a numeric input touch key are as follows:



Select the Numerical input icon in the toolbar, and a dialog box appears. As shown in Figure 4-95.

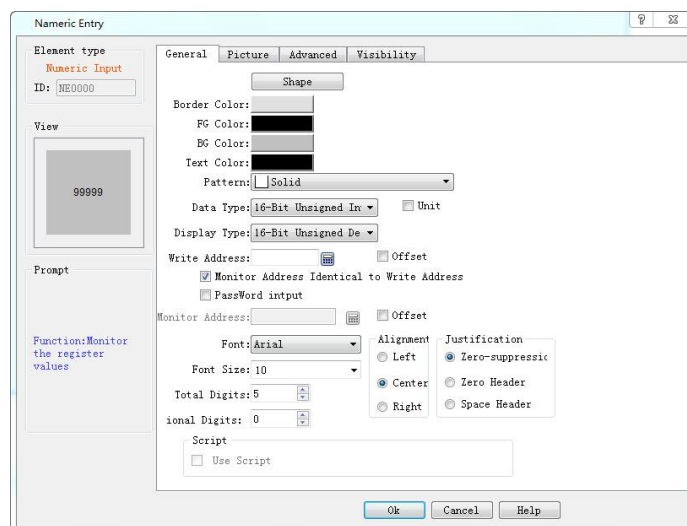

Figure 4-95 Numerical Input dialog box



Note: Shape, border color, foreground color, background color and pattern can be set with reference to "Bit



button" control.

Note: Refer to the "Numerical Display" control for "Alignment", "Justification", "Decimal Place" and "Total Digits".

Note: Double-click the data display box to reset the contents and properties of the data display. When the control functions in the HMI, an on-screen keyboard will pop up, giving an access to the data input for user, as shown in Figure 4-96.

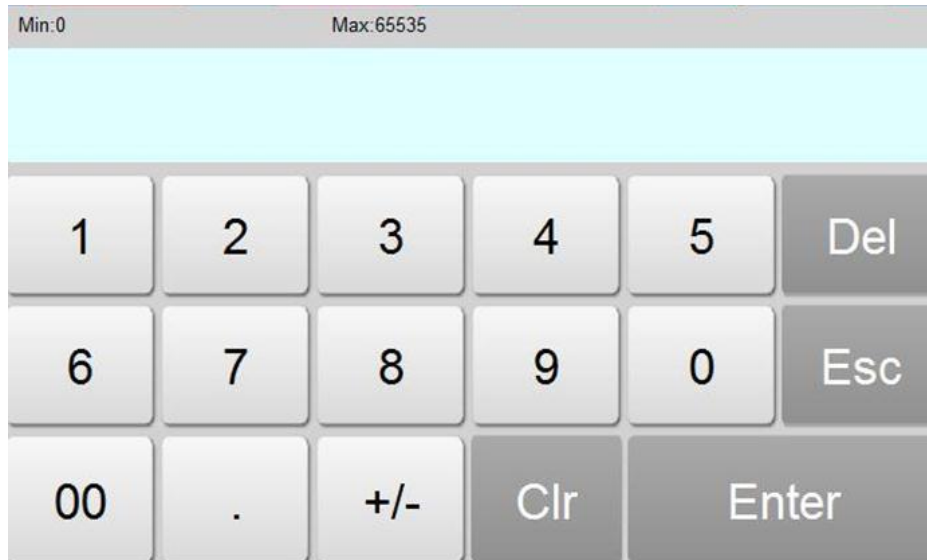

Figure 4-96 Number input keyboard



Note: When the 32-bit data type is selected, the stored address occupies 2 words. For example, when write data to the SIEMENS PLC's data register, and the address written is V10 , then the occupied data register address includes V10 and V11; if users also use other controls to monitor the value of V11, an error will appear. Users should pay attention to the use of 32-bit data types in case ofNote data and address errors.

Note: The number of decimal place affects the data display. When the selected data type is 16/32-bit positive integer, 16/32-bit integer, and then the displayed value is acquired by offsetting the decimal point of return value by the set number of digits. If the value 212 is returned and the number of decimal places is 2, then 2.12 is displayed. If the selected data type is a 32-bit floating-point number, the value has no offset; but only the fractional decimal places are displayed. If the value 2.123 is returned and the scale is set to 2, only 2.12 is displayed.

Note: Total number of bits means the sum of the length of the integer part and the fraction part. If the integer length of the displayed value is greater than that of the integer part, the length of the displayed integer will be that of the actual value. For example, for the value 2123, the length of value is 2, and number of decimal place is 1, then it will display 212.3.

- Password input: "Password input" means the password input function, and the characters entered by the user are displayed in the form of "\*" in the process of inputting and displaying.
- Use Macro: Select the option of "Use Macro" to display the list of macros. User can select a macro to execute when the numeric input button is pressed. Only compiled macros are displayed in the drop-down list.
- Total digit: The total number, the sum of the integer part and the sum of the decimal parts. Controls the size of display and input values. The total number of decimal places is 4, and the decimal number is 1. The maximum decimal value is 999.9, which is the maximum value of the input and display of the control. The input exceeds the value, indicating errors; the display exceeds this value, ignores the redundant bits, and displays the number of settings only. Such as: total number of 4, decimal 1, the actual value of 12345, the control display effect of 234.5.

"Advanced" page: This page is mainly used to set the gain, offset and range check of input data (to check whether the input value is beyond the set range); In addition, the advanced page also has "Touch availability" and "Notification" options, which have the same functionality as that of the "Bit Button" control which users can refer to.

Click the "Advanced" tab, as shown in Figure 4-97:

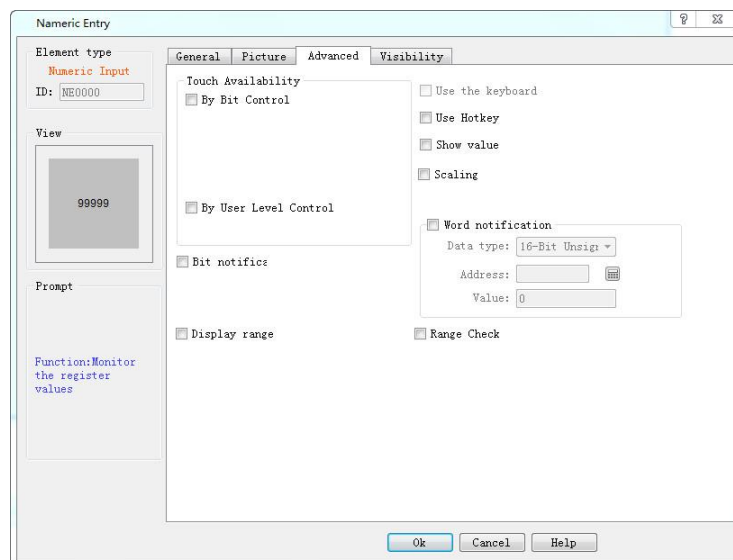
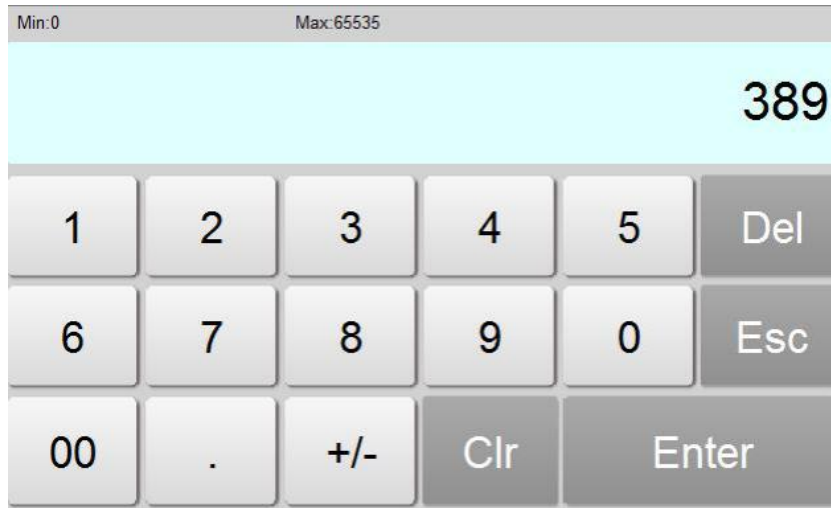

Figure 4-97 Numeric Input Advanced page

- Controlled by Bit: If select this option, the control is not available until under specific conditions. When the "Valid Status" selected is 1, the "Bit Button" can be effectively touched if and only if the value of the "Control Bit" is 1. When the selected "Valid Status" is 0, the "Bit Button" can only be effective if and only if the value of the "Control Bit" is set to 0. Otherwise, the "Bit Button" cannot function no matter how.

- Controlled by User Level: User can select multiple options as needed. After setting, in the simulation or on the HMI screen, the current user is checked whether this user lever has the Visibility.
- Use Hot Keys: Refer to the Bit button.
- Show value: If select this option, the user data input, it will display the control value in the input keyboard when user inputs values, for example, the display value is 389, click on the Numerical input control, then the input area will show 389, otherwise the input area is empty, as shown below:

Show value



For example, if option 2 and 3 are chosen in the Effective Level Controlled in the Advanced Page of the control, and the User Password Setting in the Touch Screen Parameter Setting is as shown in Figure 4-98:

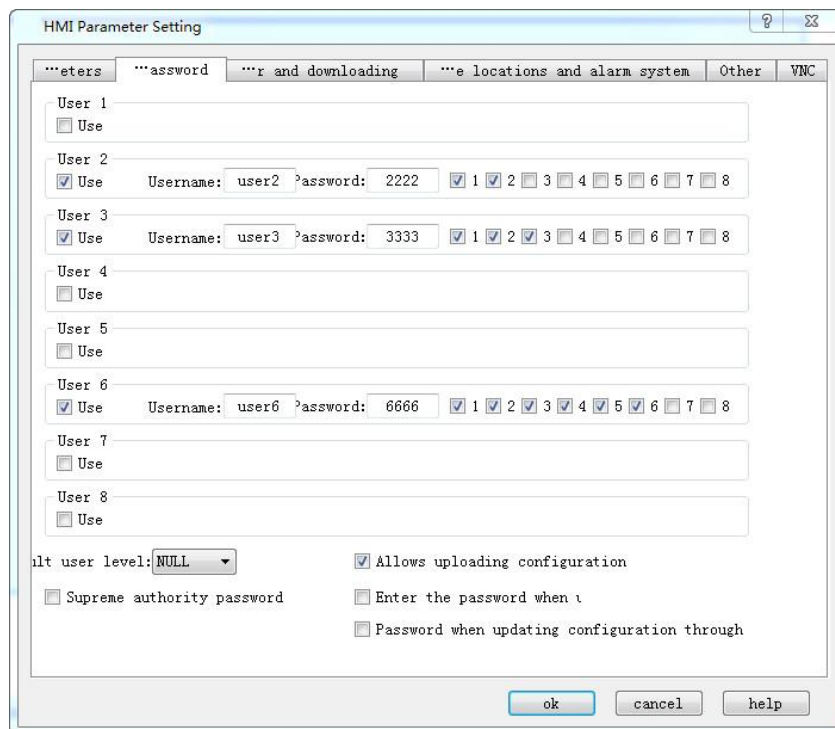
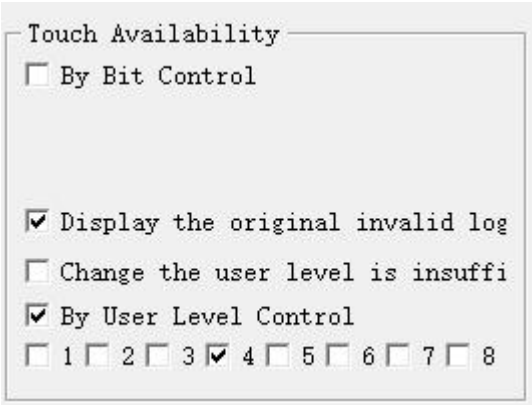
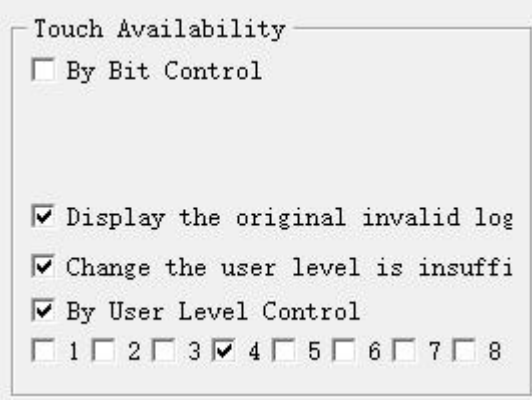

Figure 4-98 User Password Setting in the touch screen parameter setting

If Default User Level is NULL, this control is not touchable, and in this case you can use Change User Level in Function buttons to change the default level. For example, if the password entered by the user is 6666, corresponding to User Level 6, but the user chooses only option 1, not matching option 2 or 3, so the system will prompt that the password is incorrect; When the password entered by the user is 2222 or 3333, as both users have option 2, matching option 2 or 3, the password is valid and this control will be changed to a touchable control. If the Default User Level is user 2 to 3, then both user levels have option 2 to match the touching conditions, and then this control is touchable in simulation or initialized screen; If the Default User Level is user 3, then this user level does not have an option to match the touching conditions, and then this control is not touchable in simulation or initialized screen. The default setting is as shown in figure below:



If select “change the user level is insufficient”, when the user level is not matched, a login interface will pop up so that user can select a matching level and log in again, as shown below:



- Notification: In the case that the control can be touched, in the simulation or screen, click on the control to input a value through a pop-up input keyboard; then it will write the set state value (1 or 0) to the "Notice bit" address.
- Scaling: When this option is selected, the value written to the address = (the value entered by user through the pop-up keyboard - offset) / Gain; the displayed value (ie, the value of the monitor address) = the value of the monitor address × gain + offset

- Display Range: When this option is selected, user can set the lower and higher limit values as well as the low and high-level background color according to the needs. The address value monitored (read) by the control will be represented by different color patterns in the user-set lower and higher limit values.
- Variable range: the values of "Lower Limit" and "Higher Limit" are dynamically changed, depending on the address entered by the user
- Lower limit: Set the lower limit of the display. When the number displayed is lower than this limit, the background color will be the color set in Low Level Background Color.
- Higher limit: Set the higher limit of the display. When the number displayed is higher than this limit, the background color will be the color set in High Level Background Color.
- Range check: Check whether the input value is beyond the set maximum or minimum value.

After the settings, click "OK" to add the control to the view area (that is, the screen)

- When General page is set as shown below, the number is displayed in binary while we input number in decimal. When Display Type is other type, the input type is the same as the Display Type.

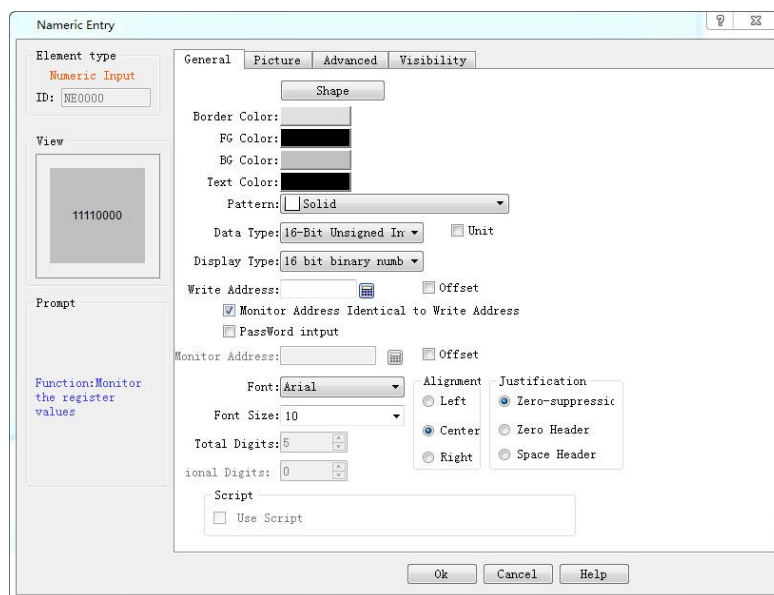

- After setting of the properties, click OK button, and then the mouse shape will become a cross. Now you can draw a rectangle in the screen by clicking the mouse and thus add this control into the screen.

## 6.5.10 ASCII Display

ASCII Display is used to displaying ASCII in device.

Click the ASCII display button icon , then a dialog box pops up as shown in Figure 4-99:

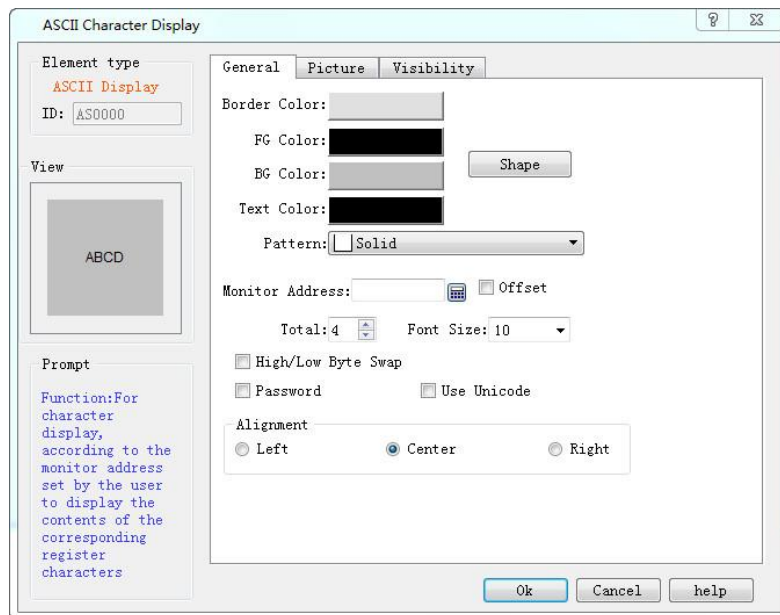

Figure 4-99 ASCII Display dialog box

In this dialog box, you can set the monitor address of the connected device to be displayed, choose the font size of the display text and other properties.

- Monitor Address: The data stored in this address can be displayed on real-time basis, or data can be input to this address.
- Total: The maximum number of characters that can be displayed.
- Font Size: The font size of the character to be displayed
- Exchange high and low bytes of input: The high byte in the value input by user will be exchanged with the low byte, and then the data after such exchange will be stored into the monitored word address.
- Password: When this is selected, the control does not show specific characters but displays an asterisk (\*)
- Use UNICODE: The monitor address value is displayed in Unicode encoding

Alignment:

- Left: The character displayed is in the left part of the display area.
- Center: The character displayed is at the center of the display area.
- Right: The character displayed is in the right part of the display area.



Note: Refer to Bit Button control for Shape, Border color, Foreground color, Background color and Pattern.

Note: If set the transparency property of this control, the setting of background color is invalid.

Note: Refer to the use of "Bit button" control for the Visibility.

## 6.5.11 ASCII Input



Click the ASCII Input button icon , then a dialog box pops up as shown in Figure 4-100:

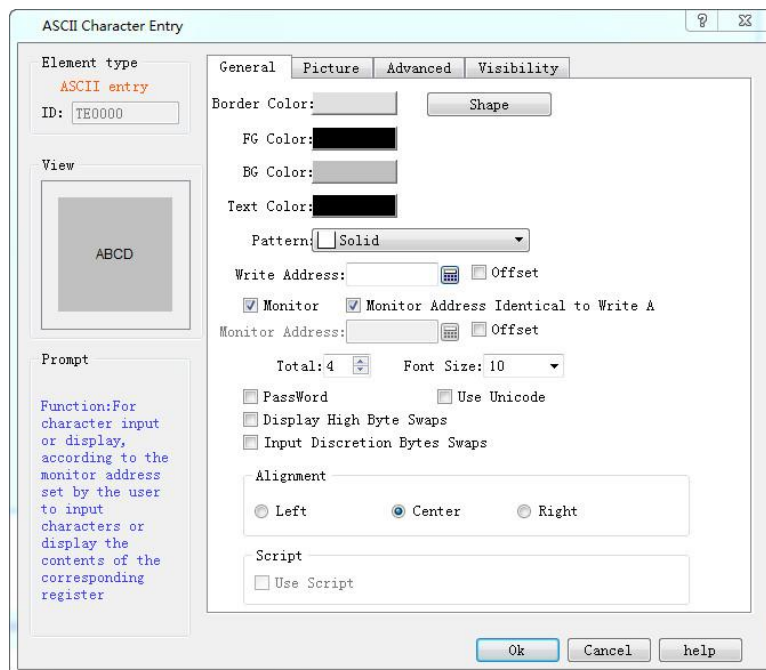

Figure 4-100 ASCII Input dialog box

- Write address: Input ASCII text into the address.
- Monitor: The address value to be read and displayed by this control.
- Monitor address identical to write address: The monitor address is the same as the write address.
- Monitor address: The address to be read
- Total: The maximum number of characters that can be displayed.
- Font Size: The font size of the character to be displayed
- Exchange high and low bytes of input: The high byte in the value input by user will be exchanged with the low byte, and then the data after such exchange will be stored into the monitored word address.

- Password: When this is selected, the control does not show specific characters but displays an asterisk (\*)
- Use UNICODE: The monitor address value is displayed in Unicode encoding

Alignment:

- Left: The character displayed is in the left part of the display area.
- Center: The character displayed is at the center of the display area.
- Right: The character displayed is in the right part of the display area.
- Use Macro: Select the option of "Use Macro" to display a list of macros. User can select one to execute when the button is pressed. Only compiled macros are displayed in the drop-down list.



Note: For example, when the 32-bit data type is selected, the stored address occupies 2 words. For example, when writing data to the SIEMENS PLC's data register, and the address written is V10 , then the occupied data register address includes V10 and V11; if users also use other controls to monitor the value of V11, an error will appear. Users should pay attention to the use of 32-bit data types in case of Note data and address errors.

Note: Other functions in General page are the same with those of SCII Display which you can refer to.

Note: Refer to Bit Button for the application of "Advanced" and "Visibility" page.

## 6.5.12 Bar Graph

Graph, also called bar graph, is mainly used to present the real-time change in the numerical values in the form of bars, so that user may view such change more visually. Graph may present the change in the numerical values of data registers of PLC or other devices connected, and also the real-time change in all analog quantities in process flows. See the figure below.

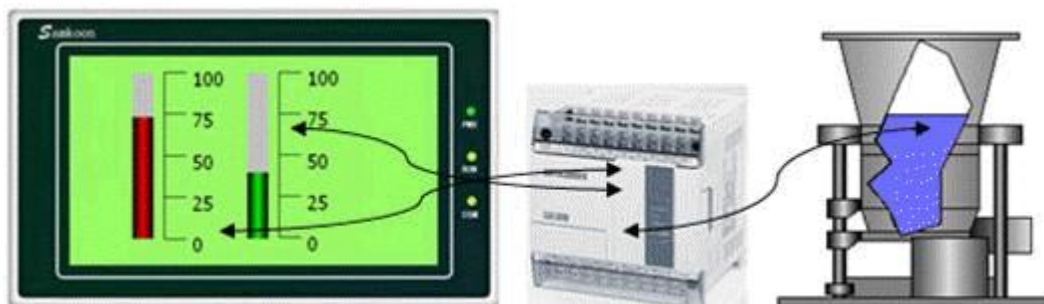



Figure 4-101 bar graph

Operations of adding a histogram (bar) and modifying the properties are as follows:



---

1. Select the Bar Chart icon  in the toolbar or the Tools menu. Then it appears a dialog box shown in Figure 4-102.

2. Set the properties of the bar graph in the Property dialog box, and then click OK:

- Background color: The background color of the bar chart
- Border Color: Set the border color of the bar. In Figure 4-102, the setting of border color is invalid; user can select the "shape" in another bar; the change is visible.
- Transparent: Set the background of the bar to be transparent
- Direction: The direction of the histogram scroll, there are four directions: Upward, Downward, Leftward and Rightward.
- Upward: When the value of the monitor address increases, the columnar surface rolls from bottom to top
- Downward: When the value of the monitor address increases, the column rolls from top to bottom
- Leftward: When the value of the monitoring address increases, the columnar surface rolls from right to left
- Rightward: When the value of the monitor address is increased, the columnar surface rolls from left to right
- Data type: The data type of the read address value, ie word address or double word address.
- Monitor address: The data register address that can be displayed in the bar, ie, the read address
- Maximum: The maximum value of the Monitor (read) address. When the value of the monitor (read) address is greater than it, the bar is full and no longer changes with the value of the monitor address
- Minimum: The minimum value of the Monitor (read) address. When the value of the monitor (read) address is less than this value, the bar is empty and no longer changes with the value of the monitor address
- Variable range: The maximum and minimum values are dynamically changed, depending on the address entered by the user; the data type of the address is the same as the set "Data type"
- Bipolar bar: It can be displayed on both sides according to the value of the data register.
- Midpoint: The midpoint of the bipolar bar.

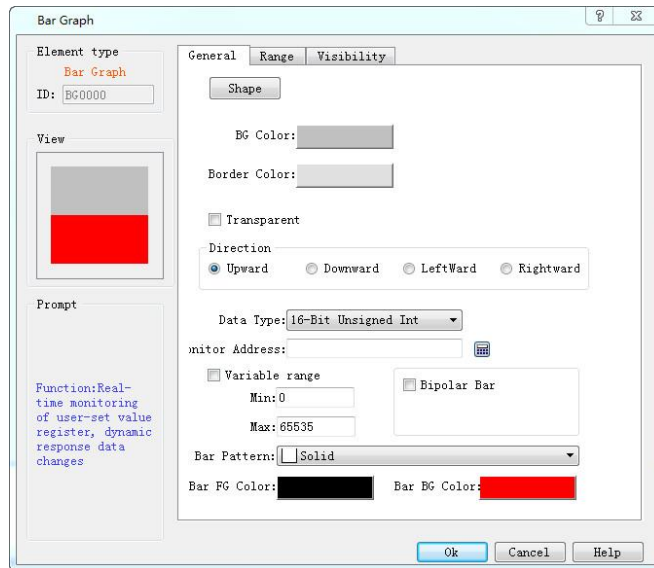

Figure 4-102 Bar chart dialog box

For example, assuming the maximum value is 100, the minimum is 10, and the scroll mode is upward, when the bipolar bar is selected, input 70 to the "Midpoint" value. Then the value incremented of the monitor address from 0 is shown in Figure 4-103.

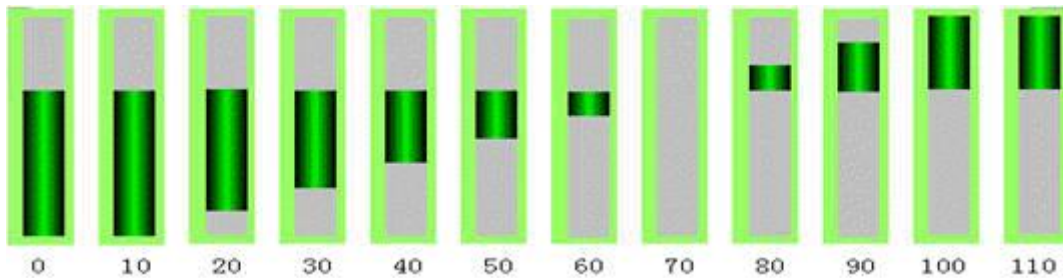

Figure 4-103 bipolar bar graph

3. Modify the bar chart: Click on the histogram, then it will appear eight small green dots that you can drag with the mouse to modify its size.

“Range” page:

This page is mainly used to display the value of the monitor address in the specified range to show a different foreground color and background color. The properties are shown in Figure 4-104:

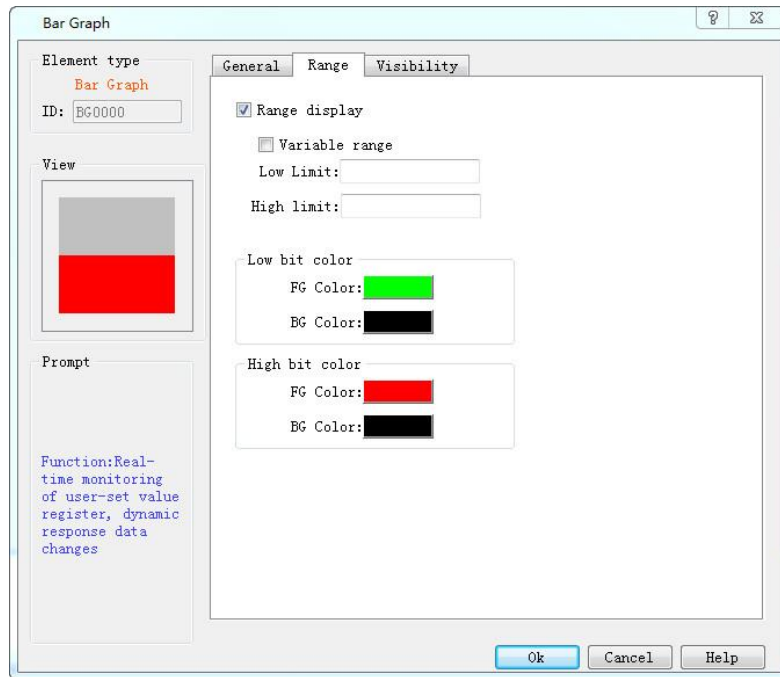

Figure 4-104 Bar Graph Range page

- Display Range: When this option is selected, user can set the lower and higher limit values as well as the low and high-level background color according to the needs. The address value monitored (read) by the control will be represented by different color patterns in the user-set lower and higher limit values.
- Variable range: the values of "Lower Limit" and "Higher Limit" are dynamically changed, depending on the address entered by the user
- Lower limit: Set the lower limit of the display. When the number displayed is lower than this limit, the background color will be the color set in Low Level Background Color.
- Higher limit: Set the higher limit of the display. When the number displayed is higher than this limit, the background color will be the color set in High Level Background Color.

After the settings, click "OK" to add the control to the view area (the screen)



Note: If the value of the monitor address is between the maximum and the minimum, the foreground and background color is identical to the settings in "General" page.

Note: Refer to "Bit button" for the application of "Visibility".

## 6.5.13 Time Display



The control of Time Display is mainly used to display the system time. Click on the control icon , then it will appear a dialog box as shown in Figure 4-105.

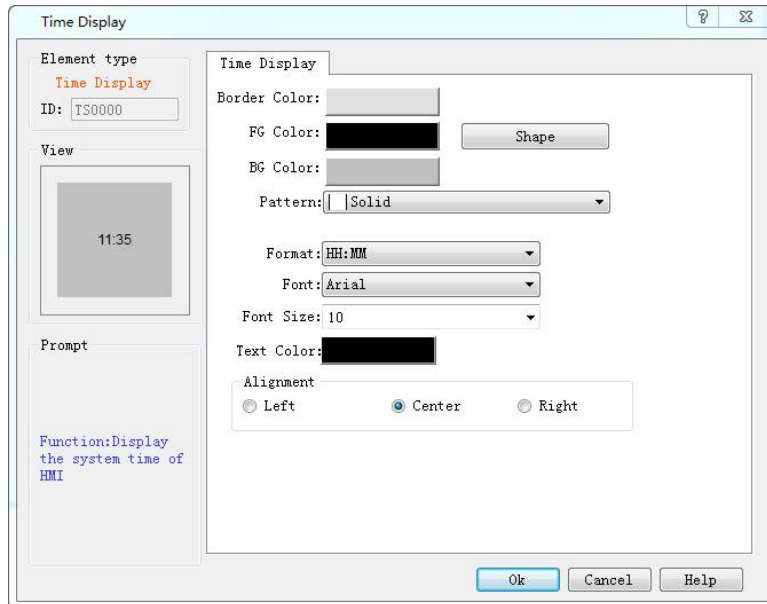

Figure 4-105 Time Display dialog box



Note: Refer to Bit Button control for Shape, Border color, Foreground color, Background color and Pattern.

- Format: Fours modes of time display for users to choose.

|          |                      |
|----------|----------------------|
| HH:MM    | Hour: Minute         |
| HH:MM:SS | Hour: Minute: Second |
| HH-MM-SS | Hour- Minute-Second  |
| HH-MM    | Hour- Minute         |

- Font: Font type of text
- Font Size: Decide the font size of time display
- Color: Decide the text color of time display
- Alignment: Decide the position of time display, left, center or right.

After the settings, click "OK" to add the control to the view area (the screen)

## 6.5.14 Date Display

The control of Date Display is mainly used to display the system date. Click in the button icon  in the toolbar, then it will appear a dialog box as shown in Figure 4-106:

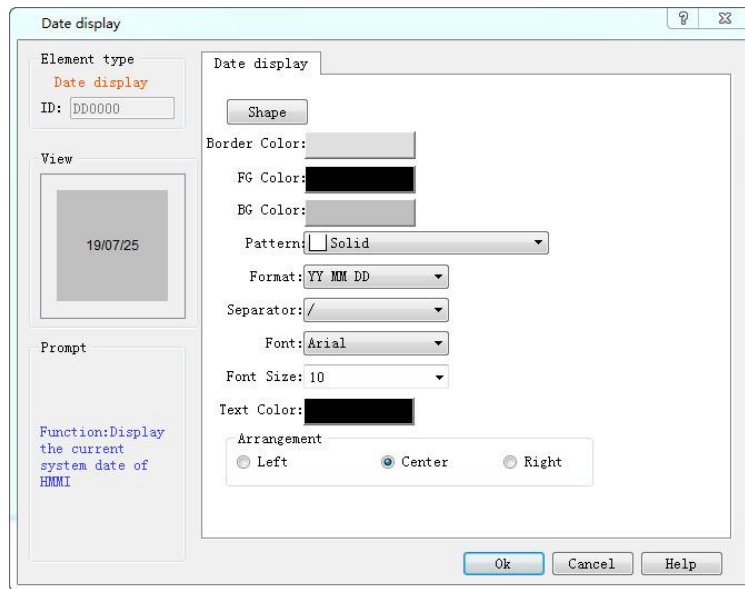

Figure 4-106 Date Display dialog box

- Format: There are nine modes of date display for user's choice.

YYYY-MM-DD

MM-DD-YYYY

DD-MM-YYYY

YYYY/MM/DD

MM/DD/YYYY

DD/MM/YYYY

YYYY.MM.DD

MM.DD.YYYY

DD.MM.YYYY

- Font: Font type of text
- Font Size: Decide the font size of time display
- Color: Decide the text color of time display
- Alignment: Decide the position of time display, left, center or right.

After the settings, click "OK" to add the control to the view area (the screen)



Note: Refer to Bit Button control for Shape, Border color, Foreground color, Background color and Pattern.

## 6.5.15 Week Display

The control of Week Display is mainly used to display the system week. Click on the button icon  in the toolbar, then a dialog box will appear as shown in Figure 4-107:

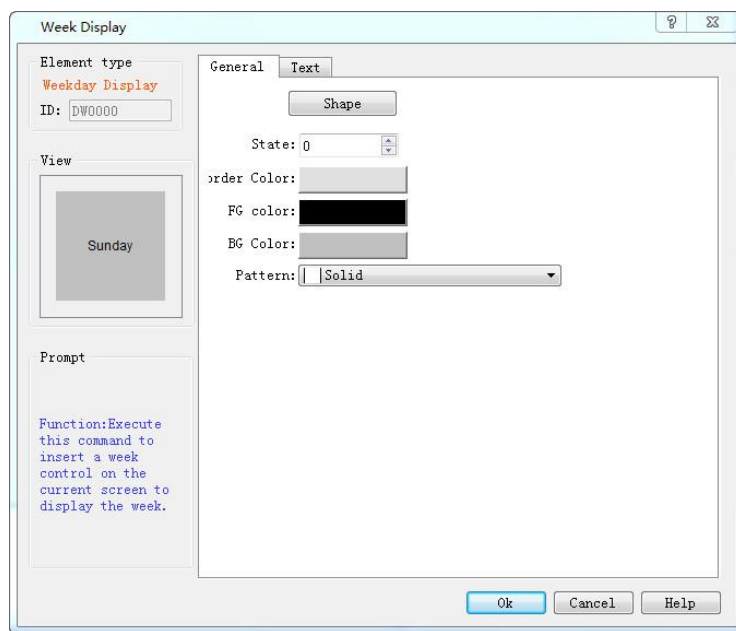

Figure 4-107 Week Display dialog box

State: Change a different status value to set the border color, foreground color, background color and pattern of different states.



Note: Refer to Bit Button control for Shape, Border color, Foreground color, Background color and Pattern.

Click on the "Text" tab where you can modify the text display, such as the text content, text size, text color, kerning, line spacing, flicker and position. "Text" page interface is shown in Figure 4-108:

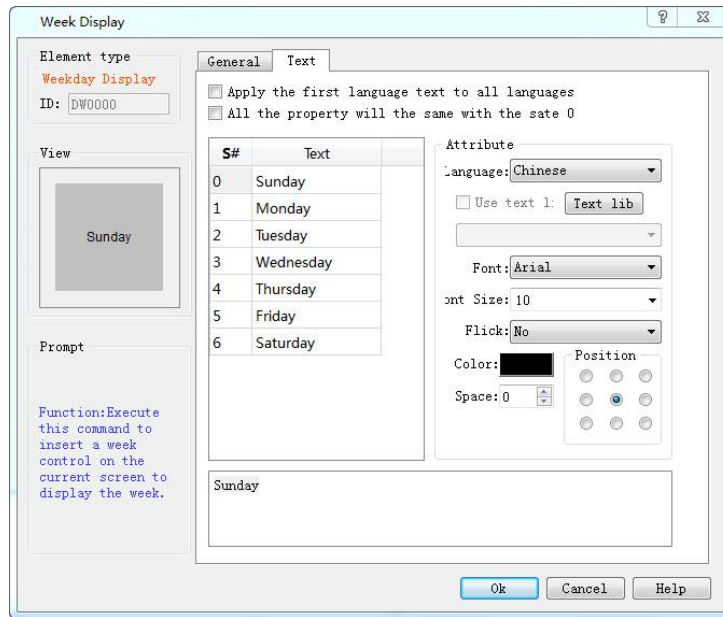

- Apply the first language text to all languages: When it comes to multiple languages (in the "Language" in the Project Manager, the total number of languages selected is greater than 1), and if this option is selected, the display contents do not change with the language switch.
- Language: This option is used when dealing with multiple languages. Select a different language, you can enter different text contents in different states, in order to achieve the multi-language. (In the function button, select the 'Switch language' option, and the language to switch to; in the simulation or screen, click this button, and then all the screen with text control will switch to that with text content of the specified language). For different languages, text content, font and font size can be different, but the color, kerning and position are the same.
- Font: Choose the font type for the input text; different states can have different fonts, and different languages can also have too.
- Font Size: Choose the font size for the input text content; different states can choose different font sizes, and different languages can also too.
- Color, Kerning, Position: Set the color, kerning, and alignment of the text in the current selection. When you select a language other than Language 1 and the total number of languages selected in the Project Manager is greater than 1, the applications of color, kerning and position are invalid because the values of the three function options are the same as those of the language 1



Note: To modify the contents of the text, first select the item to be modified in the list box, and then enter the text below the editing box.

After the settings, click "OK" to add the control to the view area (the screen)

## 6.5.16 Static Picture

The control of Static picture is mainly used to show a picture that can be in various formats from the file or from the library. With the picture loaded, it can be applied as a screen background to beautify the project interface.

1. Click on the static picture icon  on the toolbar to pop up a dialog box as shown in Figure 4-109:

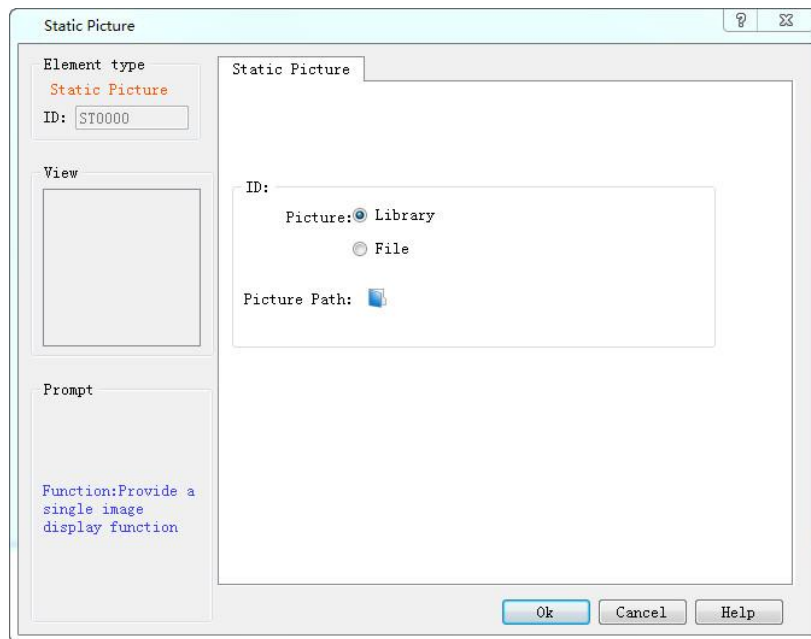

Figure 4-109 Static picture dialog box

2. After selecting a picture, click OK, and then the mouse cursor will become cross-shaped; left click on anywhere on the screen to add the picture control.
3. The size of the inserted picture can be modified through the mouse. SKTOOL configuration software supports various image formats: JPG, BMP, PNG, WMF, EMF, GIF.

## 6.5.17 Picture Display

Picture Display is an extension of the Static picture control, because the Static picture can only display one picture while Picture display can display up to 32 pictures. Picture display may have different definitions according to different status categories selected by user.

Steps are as follows:

- Click the icon of the Picture display  on the toolbar. The dialog box shown in Figure 4-110 pops up:



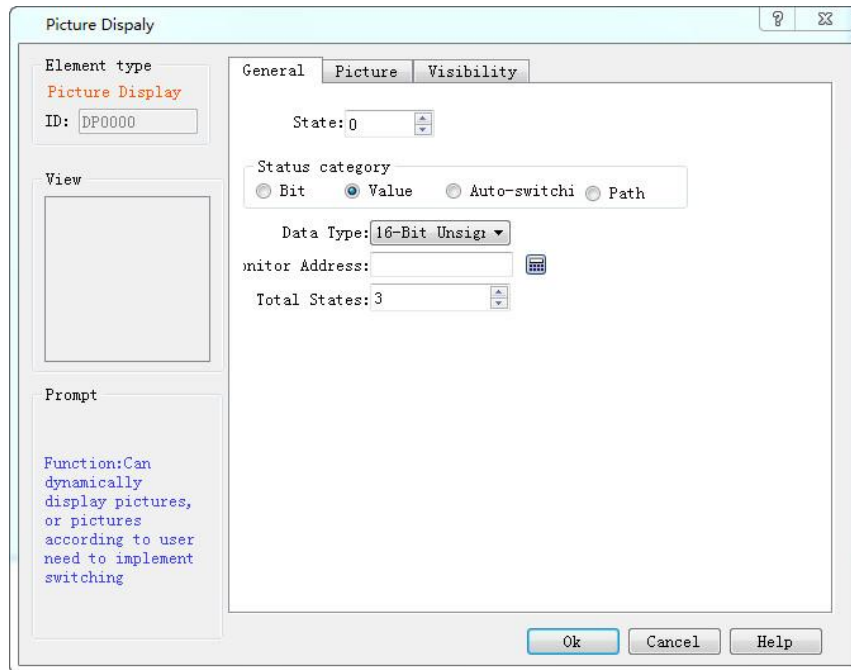

Figure 4-110 Picture Display dialog box

- Bit: When Bit is selected, the total number of states is only two, state 0 and 1. Monitor address can only be a bit address. The control displays the corresponding picture based on the state 0 or 1 of the monitor address.
- Value: When the Value option is selected, the total number of states can be up to 2048, and different pictures are displayed according to the value of the monitor address. When the value of the monitor address is 0, the picture under the state 0 is displayed, and so on.
- Auto-switching: When the auto-switching option is selected, the total number of states can be up to 2048, and the control does not need to change pictures according to the value of the monitor address, as long as user sets the total number of states; then set the automatic transformation frequency. If it runs in the HMI, the control will switch pictures automatically within the range.



Note: The "Picture" page of the Picture Display is similar to that of the "Multi-state Indicator Lamp" control that you can refer to.

Note: Refer to the "Bit button" control for the application of "Visibility".

After the settings, click "OK" to add the control to the view area (the screen).

---

## 6.6 SKTOOL New controls

### SKTOOL New controls



This chapter introduces the new controls.

#### Contents:

- [Arc Chart](#)
- [Stepping Button](#)
- [Radio Button](#)
- [Radio Button](#)
- [Slider](#)
- [Animation](#)
- [Message Board](#)
- [Data Group Display](#)
- [Keyboard](#)
- [Formula Selector](#)
- [Formula Display](#)
- [Qrcode](#)
- [Operation Log](#)
- [CornEr Flow Block](#)

- Multi Window
- Scroll Bar
- Pipelinet
- Dial

## 6.6.1 Arc Chart

The control of Arc Chart (also called Pie chart) functions similarly to the Meter, which is applied to read and reflect the value of monitor address. In this control, the reaction area can be shown by the "Pie foreground color", "Pie background color" and "Pattern". The control icon on the toolbar is  ; click on it to pop up a dialog box as shown in Figure 4-111:

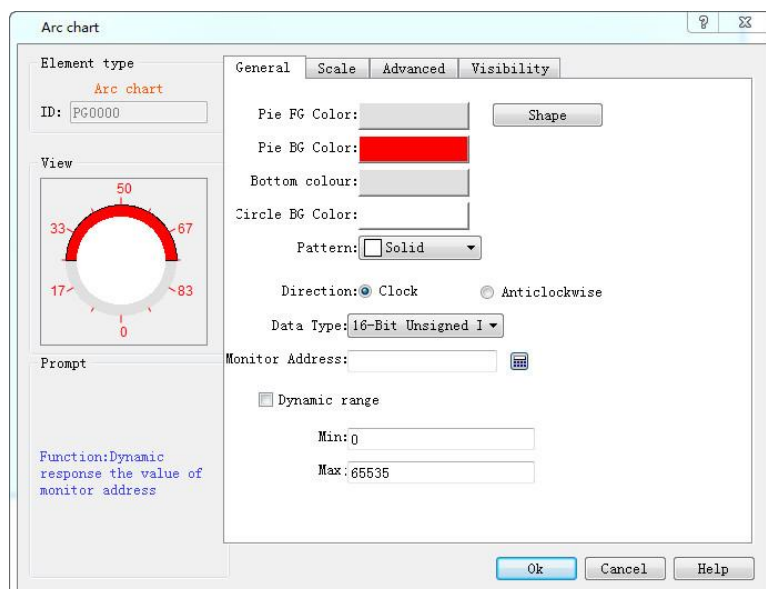

Figure 4-111 Arc Chart General Page

The Scale page dialog box, as shown in Figure 4-112:

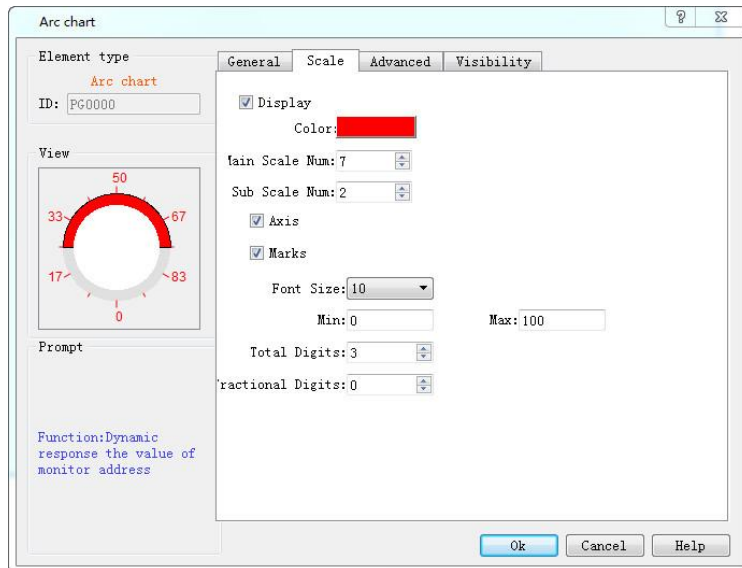

Figure 4-112 Fascicle Scale page

Refer to the scale page of “Meter” for the settings of scale.

Refer to “Numerical display” for the parameter settings of “Advanced”.

## 6.6.2 Stepping Button

This command is applied to create a stepping button control in the current screen to realize the cyclic

switching of execution states. Click the button icon  to pop up a dialog box as shown in Figure 4-113:

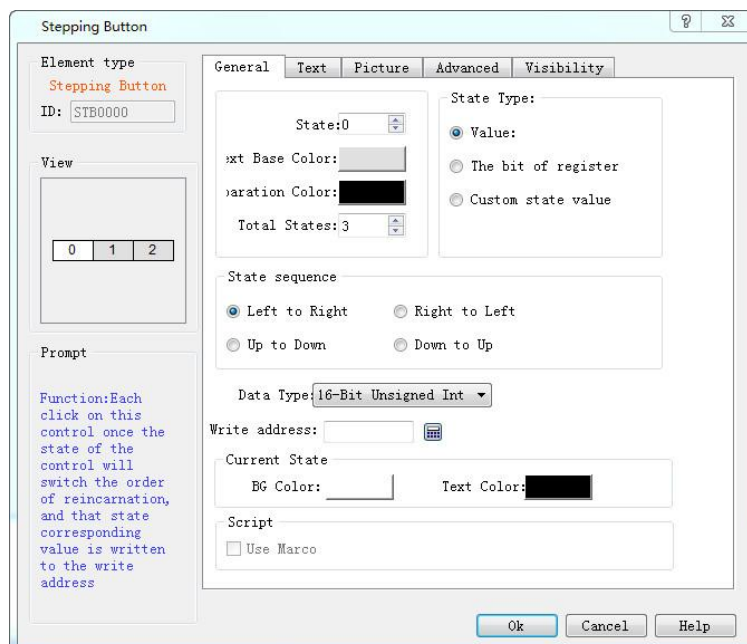

Figure 4-113 Stepping Button dialog box

State sequence: Direction of the text on the control. For example, if the total number of states is 3, then texts

of State 0, State 1 and State 2 are 0, 1, 2 respectively.

- Left to Right: The control is placed horizontally, ie the text is oriented from left to right: 0, 1, 2
- Right to Left: The control is placed horizontally, ie the text is oriented in a right-to-left orientation: 2, 1, 0
- Up to Down: The control is placed vertically; the text direction is in accordance with the direction from top to bottom: 0, 1, 2
- Down to Up: The control is placed vertically; the text direction is in accordance with the direction from bottom to top: 2, 1, 0

State Type: Refer to that of the "Multi-state Indicator Lamp".

Current state: Set the background color and text color of the text in the current state.

Refer to "Multi-state Indicator Lamp" for the parameter settings of pages of Text, Picture.

Refer to Bit button for the application of "Advanced" page and hotkeys.

E. g, assuming that the state type is "Value", the write address is LW1, the total number of states is 3, and the text of state 0, state 1 and state 2 are 0, 1 and 2 respectively; after downloading the project to HMI, keep on clicking on the control, whose state will be converted constantly between 0-2, and the corresponding value will be written to LW1.

### 6.6.3 Radio Button

This command is applied to create a radio button control in the current screen to switch to a certain state

selected by user. Click the button icon  to pop up a dialog box as shown in Figure 4-114:

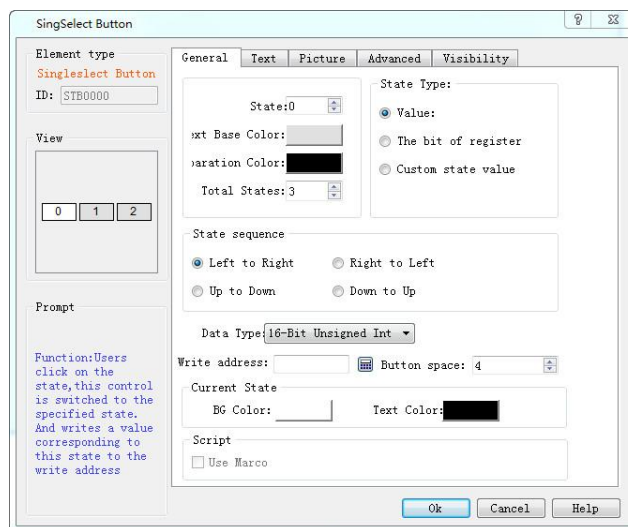

Figure 4-114 Radio Button dialog box

State sequence: Direction of the text on the control

For example, if the total number of states is 3, then texts of State 0, State 1 and State 2 are 0, 1, 2 respectively.

- Left to Right: The control is placed horizontally, ie the text is oriented from left to right: 0, 1, 2
- Right to Left: The control is placed horizontally, ie the text is oriented in a right-to-left orientation: 2, 1, 0
- Up to Down: The control is placed vertically; the text direction is in accordance with the direction from top to bottom: 0, 1, 2
- Down to Up: The control is placed vertically; the text direction is in accordance with the direction from bottom to top: 2, 1, 0

State Type: Refer to that of the "Multi-state Indicator Lamp".

Current state: Set the background color and text color of the text in the current state.

Refer to "Multi-state Indicator Lamp" for the parameter settings of pages of Text, Picture.

Refer to Bit button for the applications of "Advanced" and "Visibility".

## 6.6.4 Combo Box



The Combo Box allows you to display a list of items that can be viewed and selected by user. Once an item has been selected, the corresponding value is written to the control address of the character register.



The control icon on the toolbar is ; click on it to pop up the dialog box as shown in Figure 4-115:

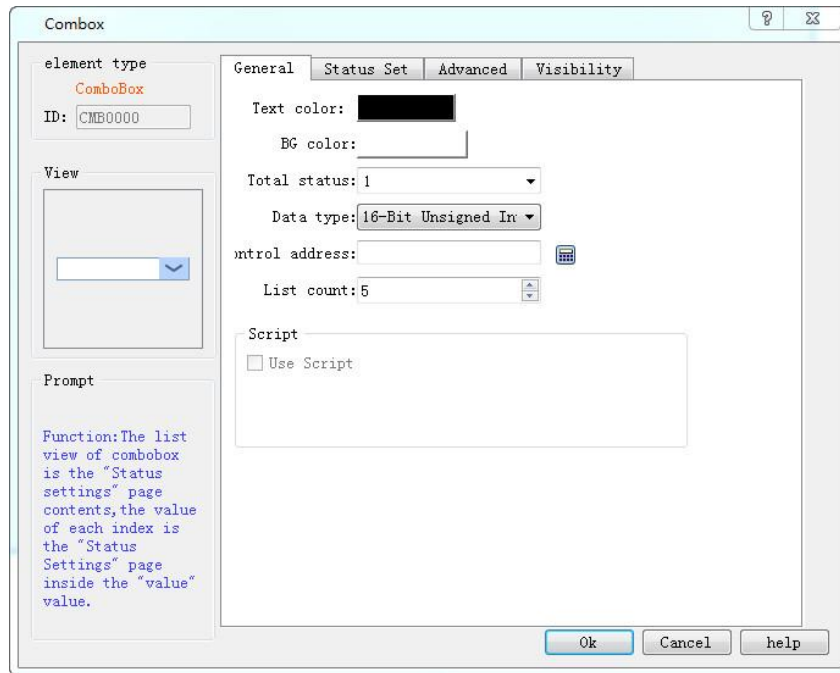

Figure 4-115 Combo box General page dialog box

- Total Number of States: Set the number of states for this object. Each item represents a status and is displayed on the list. The value of this item can be written to [Control Address].
- Background Color: Select the background color of the selected object
- Text Color: Select the text color of the selected object
- Control Address: Write address
- Use macro: Execute the selected macro if they are touchable.

Status Set: Click "Status Set" page; the following figure is shown (Figure 4-116):

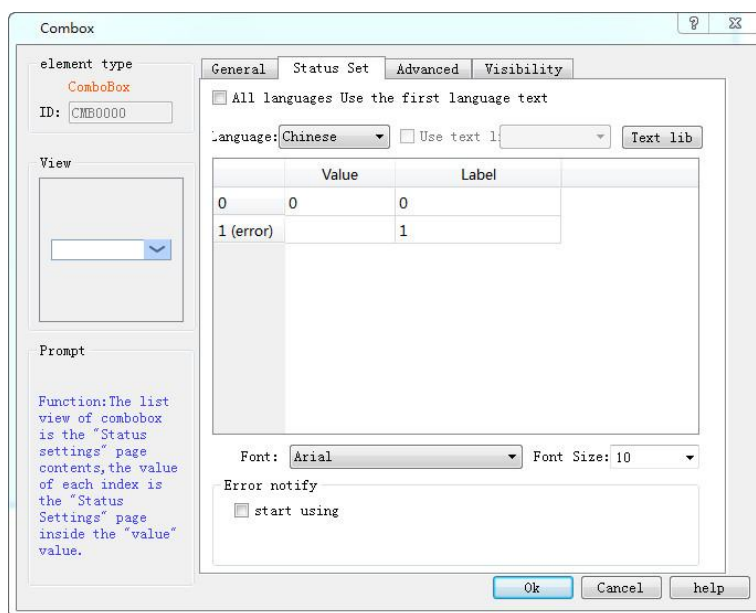

Figure 4-116 Combo box Status Set page dialog box

- Language: Use a consistent "font" and "font size" for all states while different "fonts" and "font sizes" for different languages.
- Value: Set a value for each item, but it needs to be subject to the following two specifications:
  - a. [Read]: If the system detects any change in the contents of [Control Address], the object will compare the content with its value and select the first matching item. If no item matches, it will jump to the error state and triggers the error notification bit (if set).
  - b. [Write]: When an item is selected, the system will write the value to [Control Address].
- Label: User can set text content for each item. The item menu will show texts of all the items on the list for user to view and select.
- Error notification
  - a. For example, when [Number of status] is set to 8, state 8 is the error status. Similarly, if it is 11, the state 11 is the error state.
  - b. When an error occurs, the combo menu will display the text of the error status.

When an error occurs, the system sets a specific bit to ON / OFF (written to [Error notification address]). Notification of this bit register can be used to trigger an operation to correct the error.

Refer to "Bit Button" for the application of "Advanced" and "Visibility".

## 6.6.5 Slider



Slide analog switch: drag the sliding block to change the value contents of the corresponding character register address.

Select the icon  in the toolbar and the attribute dialog box of "Slider" will appear, as shown in Figure 4-117:



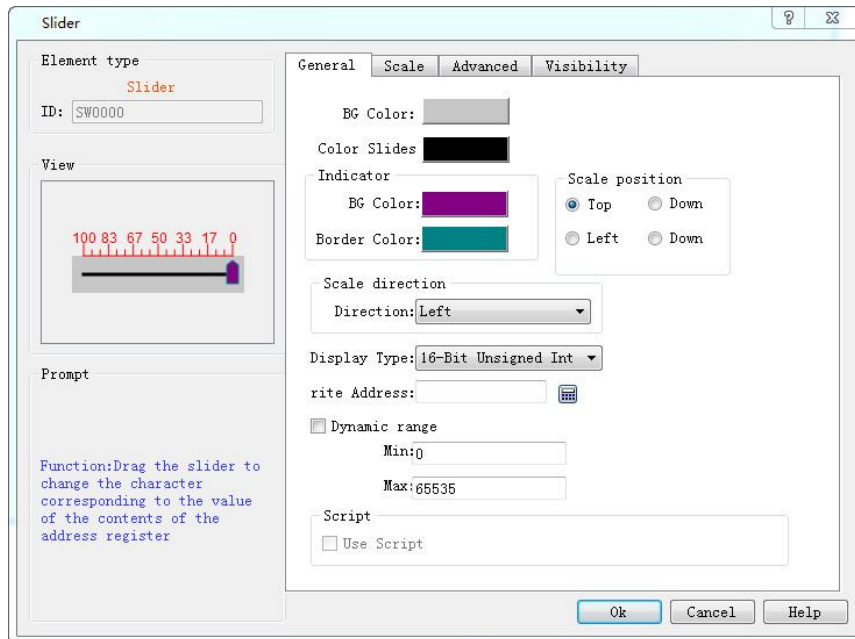

Figure 4-117 Slide dialog box

- Scale position: Select the position of scale.
- Scale direction: Select the alignment direction of scale.
- Write address: when the slider is dragged, the set value can be real-time written and displayed.
- Dynamic range: Control the slider with the word address. When the dynamic range check box is not ticked, the maximum / minimum values can be controlled by data type, and the user can also change it freely. At the moment, the movement value of the slider is actually the value here; when the dynamic range check box is ticked, the maximum / minimum values are received in the form of word address, and the maximum / minimum values are controlled through address.

Refer to “Meter” for the settings of the Scale page.

Refer to “Bit button” for the application of “Advanced” and “Visibility”.

## 6.6.6 Animation

Animation: You can define the movement of component in advance, and control its position in the trajectory through data of two registers, one controls the state and the other controls the position.

This control icon on the toolbar is: , after finishing drawing mobile points (Note: up to 64 points) in the screen area), right-click to complete the draw of moving points.

Double-click the control to bring up the pop-up dialog box shown in Figure 4-118:

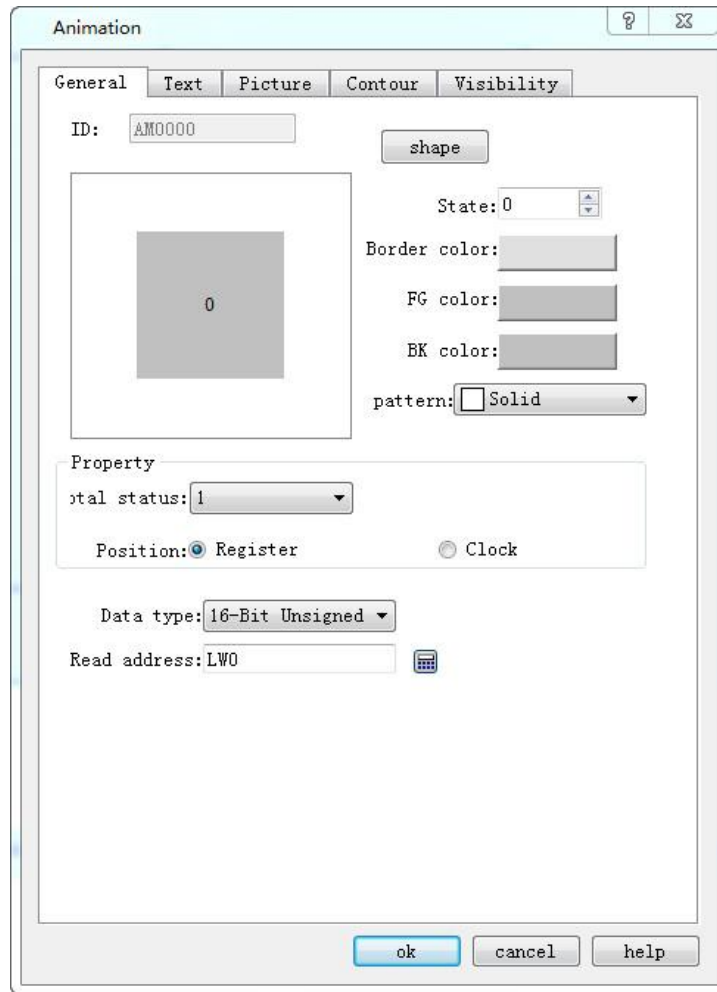

Figure 4-118 Animation General Page dialog box

Total status: Set the number of element states

Location:

Register: When "Register" is selected, the status and position of the element is controlled by the register data.

Read Address: If the status and position are determined by the data in the register, the read address of the element status and position must be set correctly. The format of the read address is shown in the table below.

| Data Type | Control address for Status | Control address for Position |
|-----------|----------------------------|------------------------------|
| 16-Bit    | Address                    | Address + 1                  |
| 32-Bit    | Address                    | Address + 2                  |

For example, if the register is [LW100] and the data format is "16-bit positive integer", [LW100] stores the state of the element, and [LW101] stores the display its position. As shown in Figure 4-119, for example, [LW100] = 2, [LW101] = 1, so the element displays state 2 and appears in position 1.

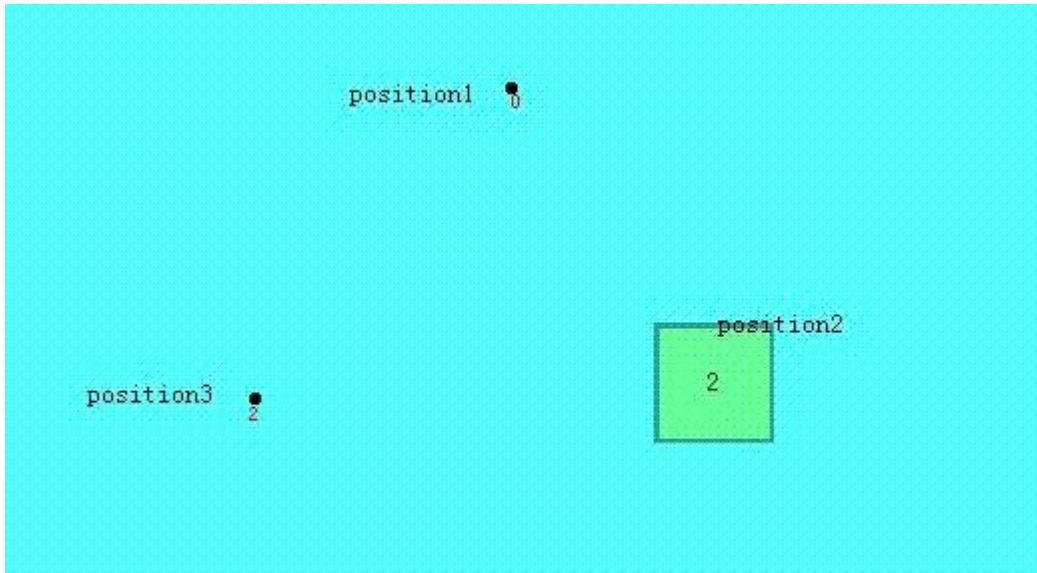

Figure 4-119

- Clock: If choose "Clock" option, the component will automatically change the status and display position. The item of "Automatic position control" is used to set the status and change mode of position.
- Speed: The speed of position change; the unit is 0.1 second. For example, 10 means the element is shifted by one position every one second.
- Back: Assume the element has four positions -- position 0, position 1, position 2 and position 3. If this option is not selected, the element will move to the initial position (position 0) when it moves to the last position (position 3), and then repeat the original position change mode.

Position 0-> position 1-> position 2-> position 3-> position 0-> position 1-> position 2...

If this option is selected, the element will move to the initial position (position 0) when it is moved to the last position, and the original position change mode will be repeated. The sequence of movement position is as follows:

Position 0-> position 1-> position 2-> position 3-> position 2-> position 1-> position 0...

Status transition: The way of state change

You can choose Position-Based or Time-Based. Selecting "Position-based" indicates that the status changes with the change of position.

If the "Time-Based" is selected, the position and status will be changed according to the points on the screen.

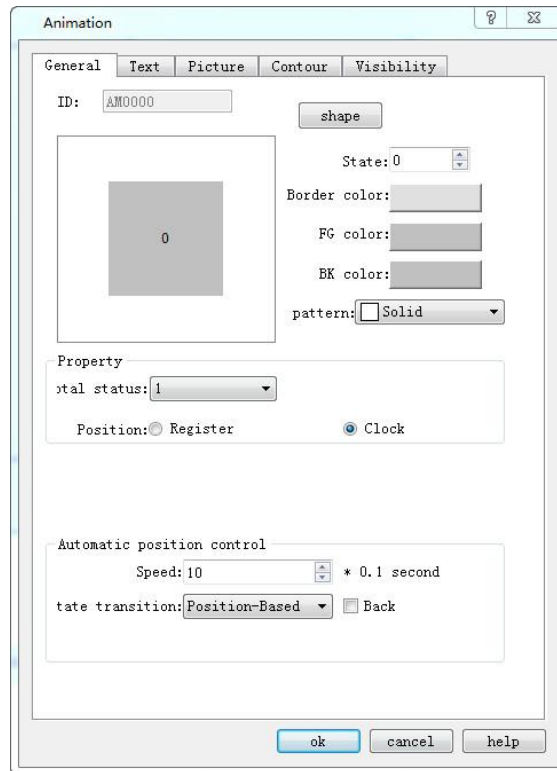
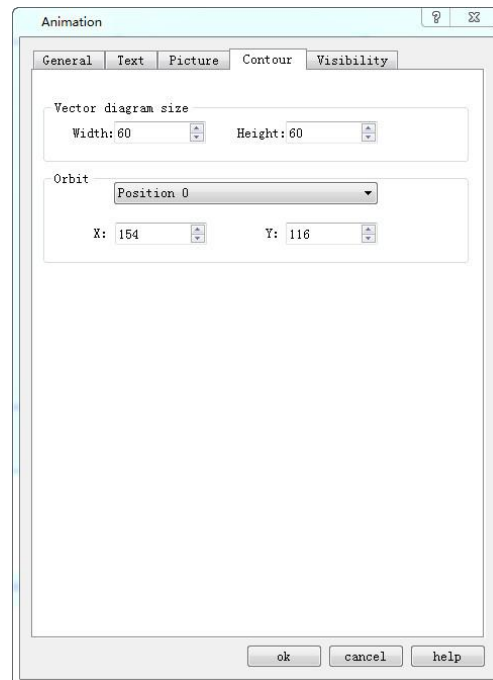

Figure 4-120 Auto control position

**Profile page:**



**Vector Diagram Size:**

- Width: Width of the graphical control in the General page.
- Height: Height of the graphical control in the General page.

- Orbit: Adjust the position of different track points by selecting them.

Refer to “Multi-state Indicator Lamp” for settings of "Text" and "Picture" page.

Refer to “Bit button” for the application of “Visibility” page.

## 6.6.7 Message Board

Message Board: A control that user can write on. The control icon on the toolbar is: . Click on this button to pop up the dialog box shown in Figure 4-121.

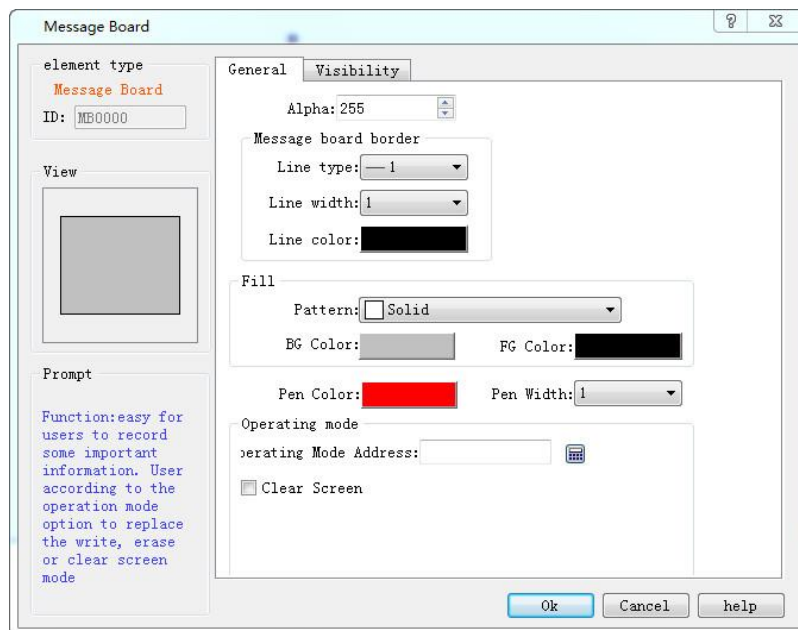

Figure 4-121 Message Board General Page dialog box

- Line color: The color of the text written on the control
- Line width: The width of the line describing the font

### ➤ Operating mode:

Operating Mode Address: This address is a word address and is valid only when the address is equal to 0 or 1. An address value equal to 0 indicates a writing operation; an address value equal to 1 indicates an erasing operation.

The address is a word address occupying 3 consecutive addresses: the first address controls the operating mode, 0 for writing operations, 1 for erasing operations; the second address controls the line width; and the third address controls the RGB color of the brush.

### ➤ Clear Screen

Clear screen address: when the address value is equal to that set by the clear screen status (0 or 1), it will erase automatically all the contents written on the control

Refer to “Bit button” for the application of “Visibility” page.

## 6.6.8 Data Group Display



Data Group Display: A data group (or block) refers to data in a group of consecutive addresses, such as LW12, LW13, LW14, LW15 and so on. The data group display element can simultaneously display the contents of a plurality of data groups. For example, the data groups from LW12 to LW15 and from RWI12 to RWI15 can be simultaneously shown so that user can observe and compare the data in each register. It is also available to draw reference curves for multiple data sets. Take the number of points as the horizontal axis, address value of each data as the vertical axis so as to judge the change trend of a value accurately and intuitively during a period of time. Up to 8 polylines (line graph) can be displayed.

The control icon on the toolbar is: ; click on the button, and then a dialog box pops up as shown in Figure 4-122:

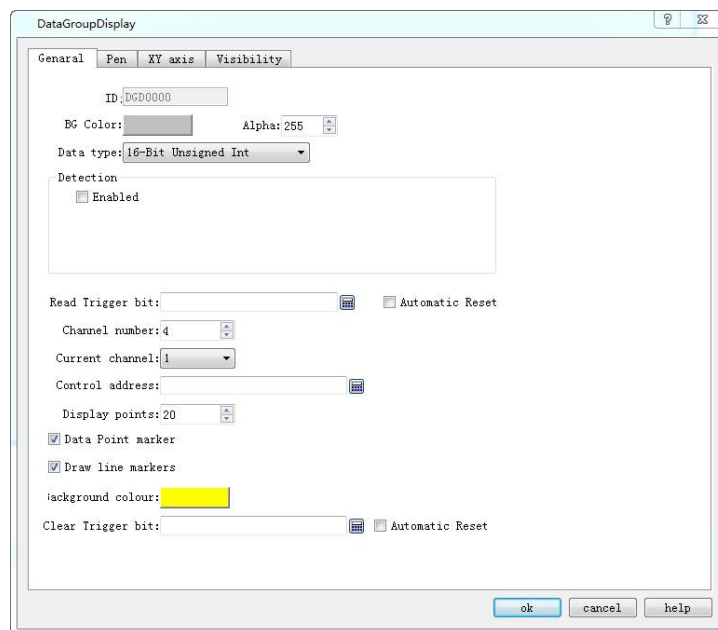

Figure 4-122 Data Group Display General dialog box

- Background color: Choose the background color of the trend graph.
- Data type: 7 data types are available for users.
- Read trigger bit: Only when the "Read trigger bit address" value is 1, the curve will move around.
- Automatic Reset: When the value of "Read Trigger Bit Address" is 1, the address will be set to 0 automatically after releasing the mouse button.
- Channel number: The number of data sets, and also the number of lines.

- Current Channel: Select a different channel to set the address for [Control Address] of different channels.

➤ Control Address: Read Address. There are different control addresses for different channels.

This address can be set with diverse initial address according to different channel number; | the length of the address = Len \* Display points (when the data type is 16-digit, len = 1; when the data type is 32, len = 2 ).

For example, if the initial address of channel 1 is LW1, the data type is 32-bit integer, and the display points is 4, the address occupied by channel 1 is LW1 LW3 LW5 LW7;

- Display points: Quantity of control addresses to read for each channel.

➤ Detection

- Enabled: Whether the detection line (reference line) is enabled.
- Color: The color of the detection line (reference line).
- Detection address: Write the current corresponding value of the detection line to the detection address register.

➤ For example

16-Bit, 4 Channel number, 10 Display points, LW1 for Channel 1 [Control Address]; LW100 for Channel 2 [Control Address]; LW200 for Channel 3[Control Address]; RWI1 for Channel 4 [Control Address]. Then:

Line 1: LW1 to LW10

Line 2: LW100 to LW109

Line 3: LW200 to LW209

Line 4: RWI1 to RWI10

If 32-bit data type, other settings remain unchanged:

Line 1: LW1 to LW20

Line 2: LW100 to LW119

Line 3: LW200 to LW219

Line 4: RWI1 to RWI20

Therefore, when select 32-bit data type and set N-group data, then the N group address value can be read by plus 2 (interval) according to address rules of the different PLC models.

- Background color: The color of the line movement area.

- Clear Trigger Bit: Clears the current status of all lines when the Clear trigger bit address has a value change of 0 to 1 (rising edge); otherwise it remains no change when the value falls from 1 to 0 (falling edge) or has no change.
- Data Point marker: Each line is composed of points
- Draw line markers: Each line is composed of lines.



Refer to “Bit button” for the application of “Visibility” page.

## 6.6.9 Keyboard

**1. Keyboard:** This control is employed to customize the keyboard, composed of each button on the keyboard. The icon of the control on the toolbar is: ; Click on the button, then a dialog box shown in Figure 4-123 will pop up.

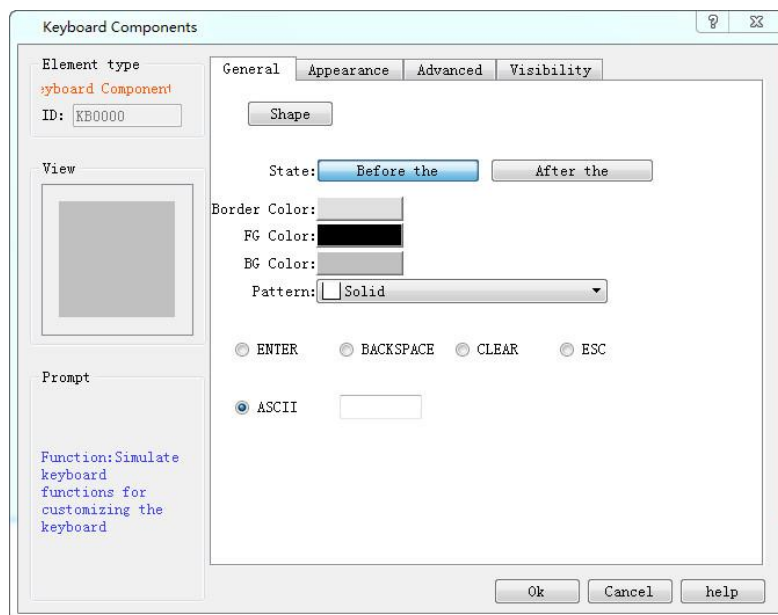

Figure 4-123 Keyboard General Page dialog box

- State: Click "Before" and "After" buttons to set the border color, foreground color, background color and pattern in different states.
- ENTER: Function button, whose role is to realize the input
- BACKSPACE: Function button, which is used for backspace deletion
- CLEAR: Function button applied to clear all the contents that have been input
- ESC: Function button to cancel the currently ejected keyboard, without entering anything
- ASCII: The value entered by the keyboard

Refer to “Bit button” for the application of “Visibility” page.

### 2. Way to add a user-defined keyboard



Start up the guide to add keyboard by means of the Add User-defined Keyboard in the Setting menu. Using this guide, user may quickly add a user-defined keyboard that has been built in the program, as shown in the figure below:



Figure 4-124 Page 1 of user-defined keyboard guide

Click Next, and an interface will pop up for keyboard type choosing. You may choose the type of the keyboard to be added in this interface, as shown in the figure below:



Figure 4-125 Page 2 of user-defined keyboard guide

After selecting the keyboard type you want to add, click Next to load the pre-defined keyboard. There are

nine predefined keyboards available for loading. The user can add the required keyboard as needed. The maximum added keyboard number could be 32, as shown in Figure 4-126

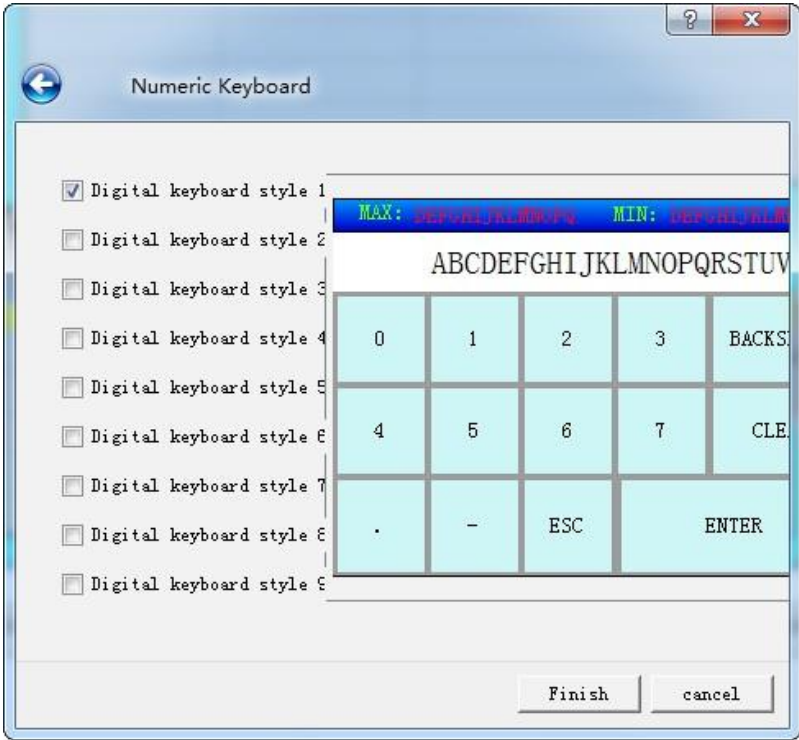



Figure 4-126 Page 3 of user-defined keyboard guide

Click OK to add the selected keyboard to the project.

### 6.6.10 Recipe Selector



The function of the Recipe selector is to list all recipe names in the case of recipe creation. Selecting the specified recipe name in the list causes the recipe number to be written to recipe number register RW10. Correspondingly, if the value of the recipe number register RW10 is changed, the recipe selector will also point to the specified recipe name accordingly. The control icon on the toolbar is: ; click the icon to pop up the dialog box shown below:

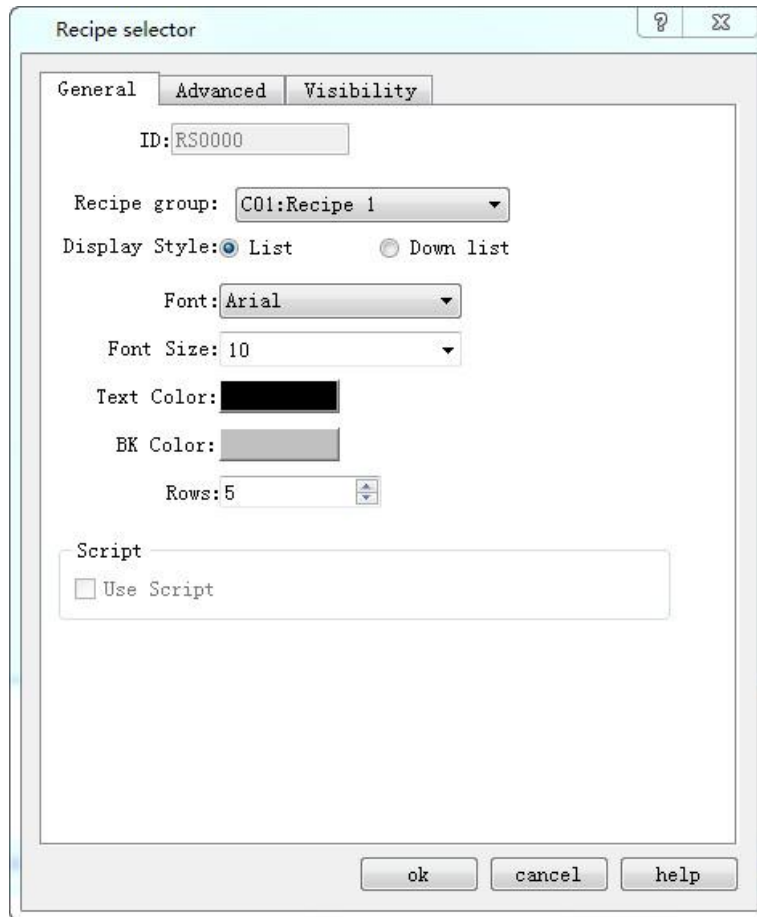

Figure 4-127 Recipe Selector dialog box

➤ Display style

Set the display style of the recipe selector

List: The recipe selector will be displayed in the form of a list.

Dropdown box: The recipe selector will be displayed in the form of dropdown box.

- Font, Font size, Text color, and Background color are settings for list box properties and text content properties
- Rows: This option is only available when "List" is selected for the display style.

SKTOOL adds a new function of multiple sets of recipe; developers can choose which recipe to display while use this control, as shown below:

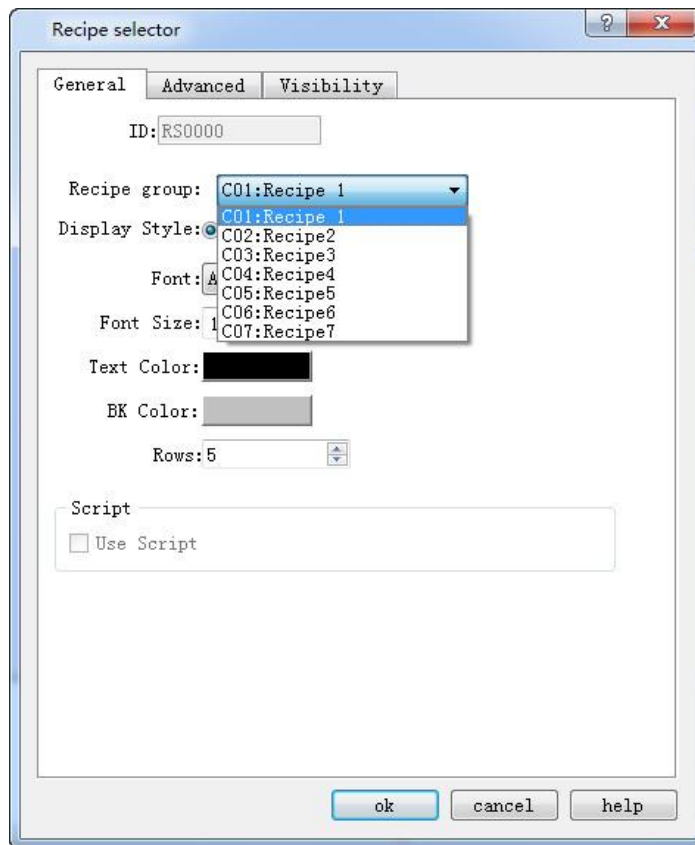



Figure 4-128 Select the Recipe displayed

### 6.6.11 Recipe Display



The function of recipe display is to list the data of all recipes if any recipe has been established. The icon of this control in the tool bar is . Click this icon, and then the following dialog box will pop up:

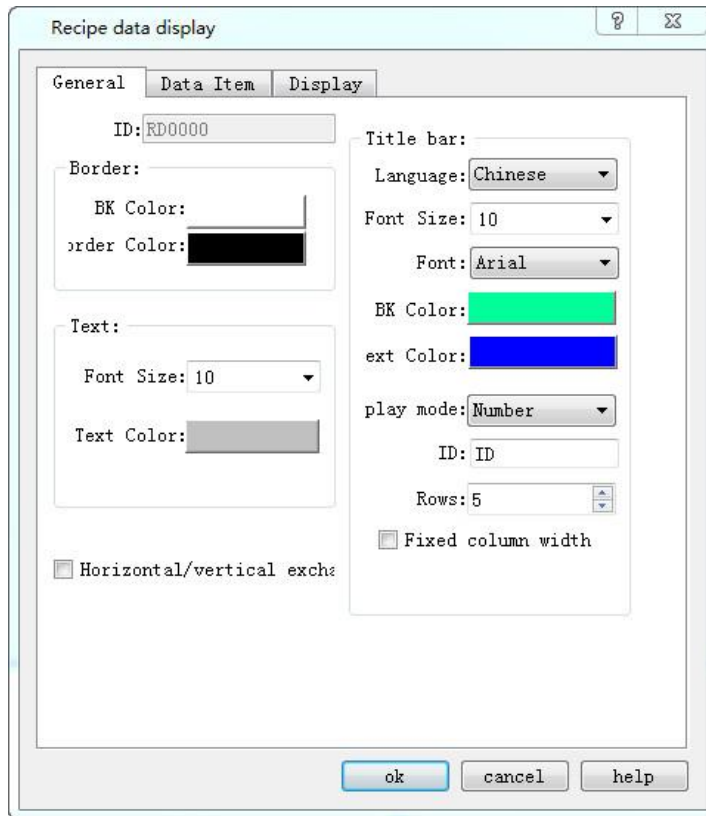

Figure 4-129 Recipe Display General page

General page consists of settings of text contents and list properties.

Data Item page, as shown below

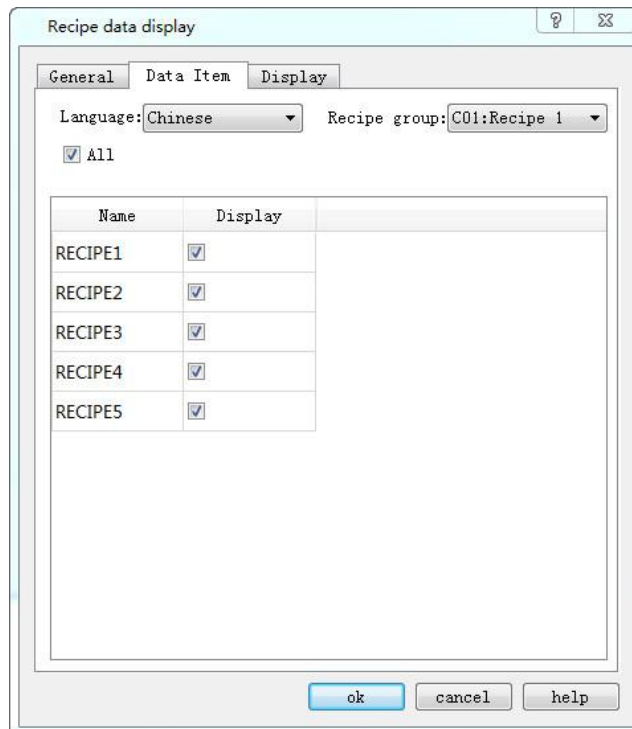

Figure 4-130 Recipe Display Data page

- Language: Choose a different language to list recipe names in different languages.
- Name: List of all recipe names
- Display: Whether to display the recipe according to user's need.
- ALL: Select all sections in Display.

SKTOOL adds the function of multiple groups of recipe; developers can choose which recipe to display while use this control, as shown below:

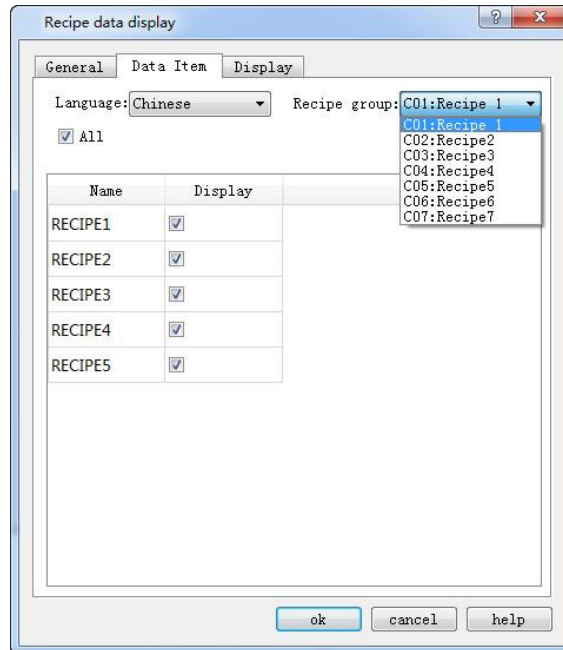



Figure 4-131 Recipe Display select recipe displayed

## 6.6.12 Qrcode

Select the control icon  on the toolbar and set its properties in the dialog box shown below:

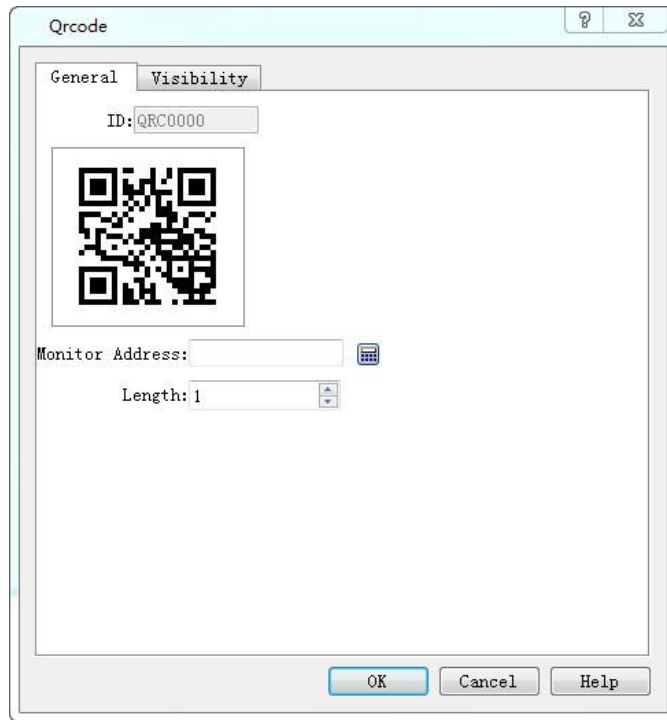



Figure 4-132 Qrcode dialog box

- Monitor Address: Address to monitor through Qrcode
- Length: The maximum length of the character that can be displayed

### 6.6.13 Operation Log

Select the control icon  on the toolbar and set its properties in the dialog box shown below:

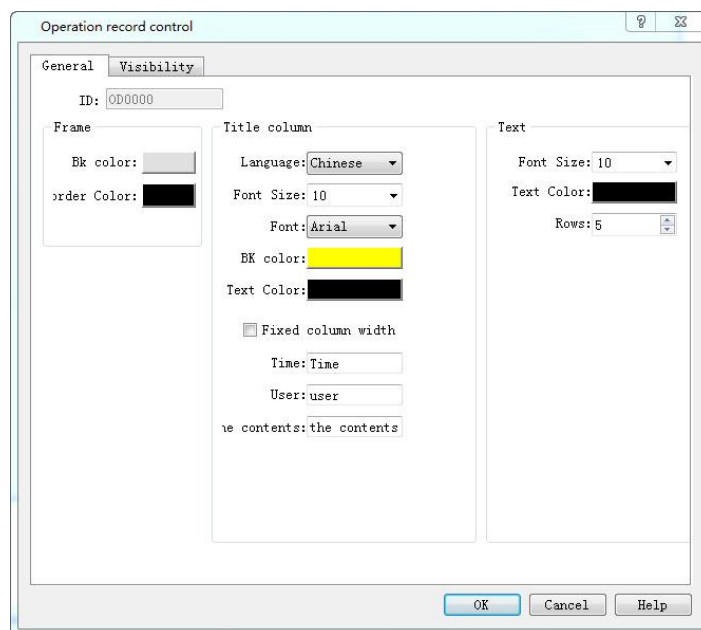

Figure 4-133 Operation Log General dialog box

- Background color: Set the background color of display control
- Border color: Set the border color of display control
- Language: Set the text content on the title bar when select multi-language
- Font size: Font size of title bar
- Background color: Background color of title bar
- Text color: Font color of title bar
- Time: Text to display in the Time column of title bar
- User: Text to display in the User column of title bar
- Operation content: Text to display in the content column of title bar
- Font size: Font size of record text
- Text color: Text color of record text
- Rows: The maximum number of rows the control can display



To enable the HMI operation record, it needs to set the value of LW60600 equal to 1 and the variable table is not empty;

The operation log can only record the variable operation in the variable table.

## 6.6.14 Corner Flow Block



The function of corner flow block is similar to the flow block. The difference is corner flow block increased corner drawing function, and it is more flexible than flow block.

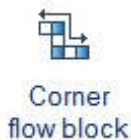

Click icon on the Toolbox, move mouse cursor to the Picture area window, it will get a tracking cross. Click the tracking cross on the starting position of corner flow block, and then move the mouse, there is a line between starting position and tracking cross, click the cross on the ending position of corner flow block, you can get first block. The ending position is also the next block's starting position, the rotation angle is 90°. So you can get multi segment flow blocks. Right click can quit drawing. The demonstration effect as



shown figure 4-134.

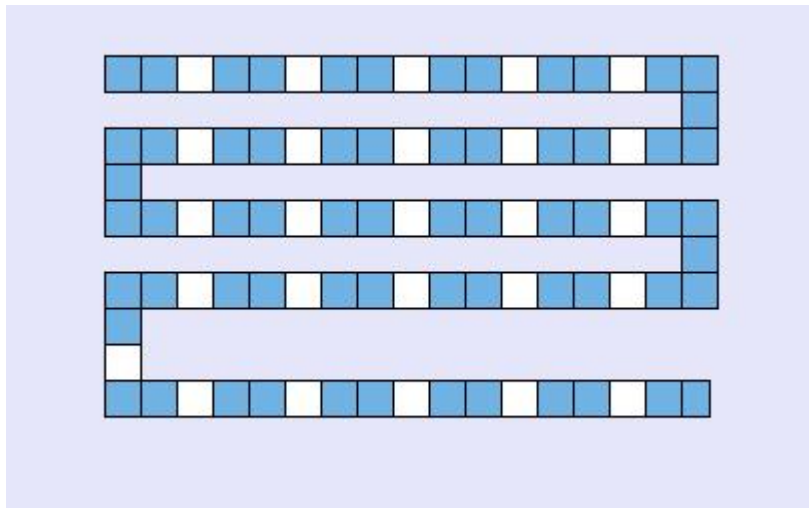

Figure4-134 corner flow block

After drawing complete, double click the block or right click choose attribute, it will pop up a corner flow block dialog, as shown figure 4-135.

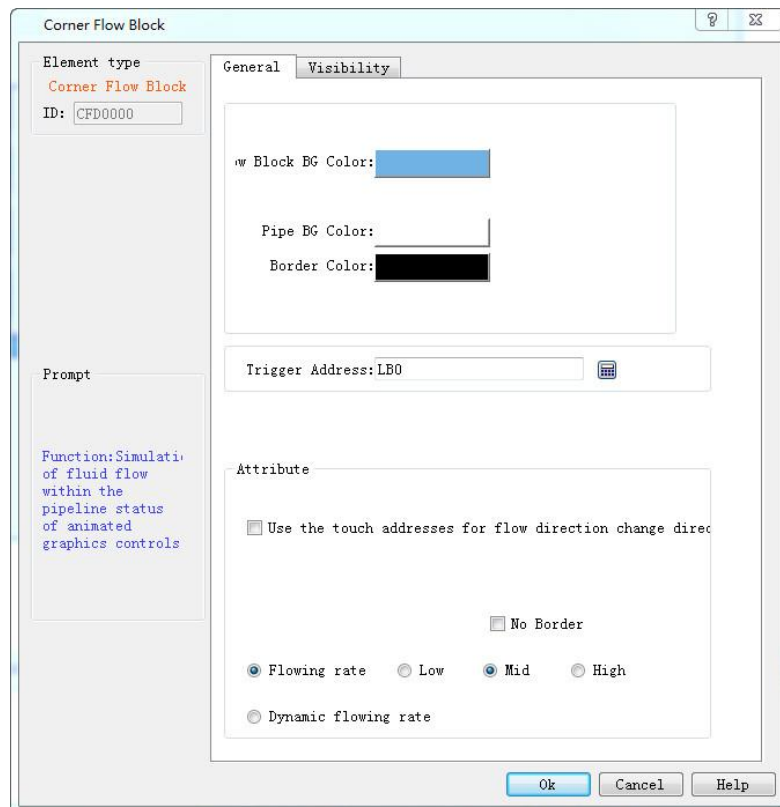

Figure4-135corner flow block dialog

Color: Set the color properties of the Flow block.

- Flow block foreground color: Click on the color button to set the Flow block foreground color;

- Flow block background color: Click on the color button to set the Flow block background color;
- Pipe foreground color: Click on the color button to set its foreground color;
- Pipe background color: Click on the color button to set the pipe background color;
- Border color: Click on the button to set the border color of the Flow block control;
- Pattern: Click to select the pattern of the Flow block control; the default setting is "Solid".
- Trigger Address: Address that controls the stationary or moving of the Flow block; when the value of the address is 1, then the block flows.
- Attribute: Set the properties of the Flow block, such as direction, flow speed.
- Display Mode: Select "Horizontal" to make the Flow block move horizontally; and select "Vertical" to make it flow vertically.
- Direction: When the display mode is "Horizontal", you can choose "Left" or "Right"; in another case, "Up" or "Down".
- Change the flow direction to the opposite direction through the trigger address: when the "Trigger address" value is equal to that of the "Effective status" set by user, the Flow direction is switched to the opposite.

For example, If "Flow direction" is "Left", this option is selected, "Trigger address" is LB2, and "Effective Status" is set to 1, then when the value of LB2 is 1, the direction of the Flow block is switched to "Right", while when the value of LB2 is 0, the direction is changed back to the original "Left".

- Blocks: The number of Flow units, ranging from 1 to 30;
- No Border: When this attribute is selected, the edges of the Flow block are hidden.
- Flow rate: Either fixed rate or dynamic rate
- Fixed Flow rate: High, Middle or Low.
- Dynamic Flow rate: The Flow rate is determined by the value of a word address, which should be between 1 and 10. When the value is 0, the Flow block does not flow; When the value is 1, the Flow block flows at the lowest rate; When the value is 10, the Flow block flows at the highest rate.



The "Visibility" page can refer to that of "Bit Button" control.

## 6.6.15 Multi Window



### Multi Window

Multi-window provide a rectangle area to show assigned window.



Multi-window

Click icon on the Toolbox, it will pop up a multi-window dialog, as shown figure 4-136.

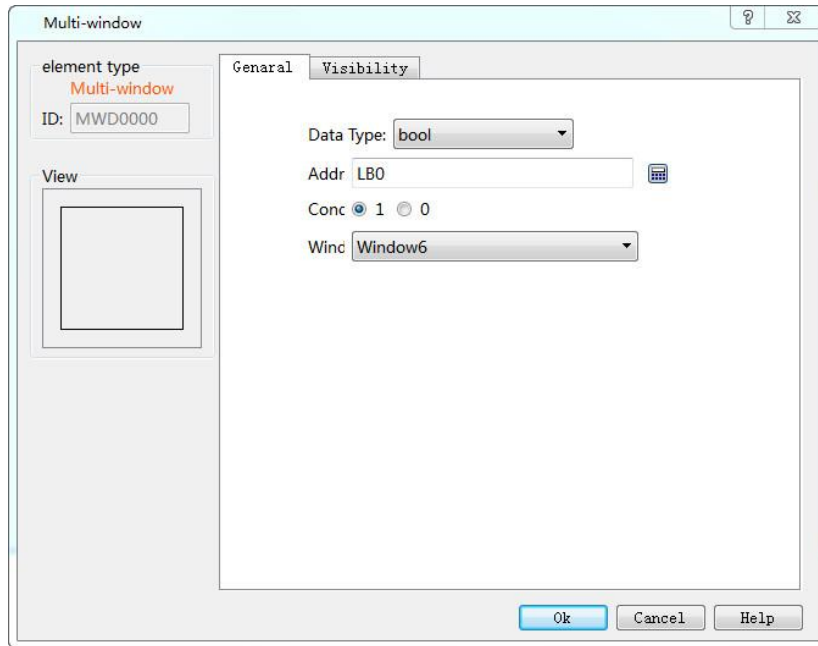

Figure 4-136 Multi-window dialog

- Data Type: the Type of data that control the showed window. include of bool and word.

“bool”: opening the assigned window on the rectangle area are judged by suit the condition.

“Word”: Choose the control address, and check “Bind with window” or “Not bind with window”, as figure

4-138 shown.

- Address: the value of address controls the window opening;

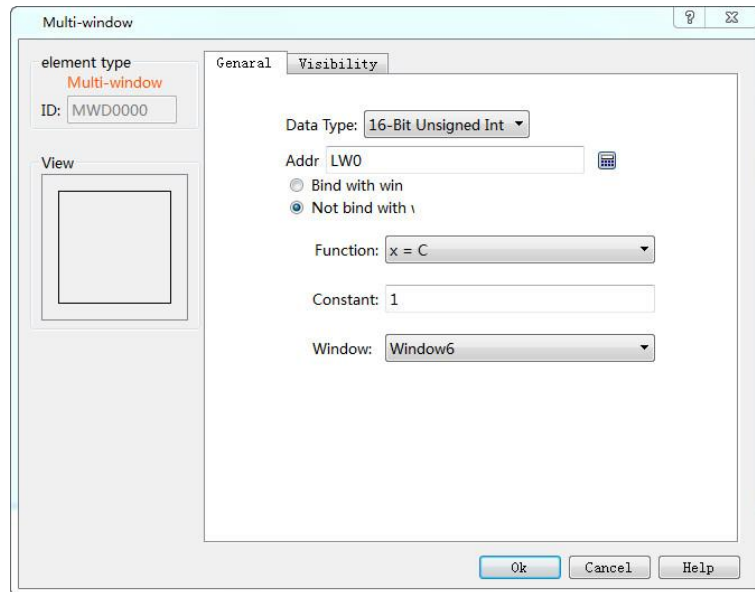

Figure 4-138 multi-window dialog

“Bind with window”:The value of address is the ID of assigned window.

“Not Bind with window”: Check a function,when fit the condition of function,open the assigned window.The functions is as shown follow.

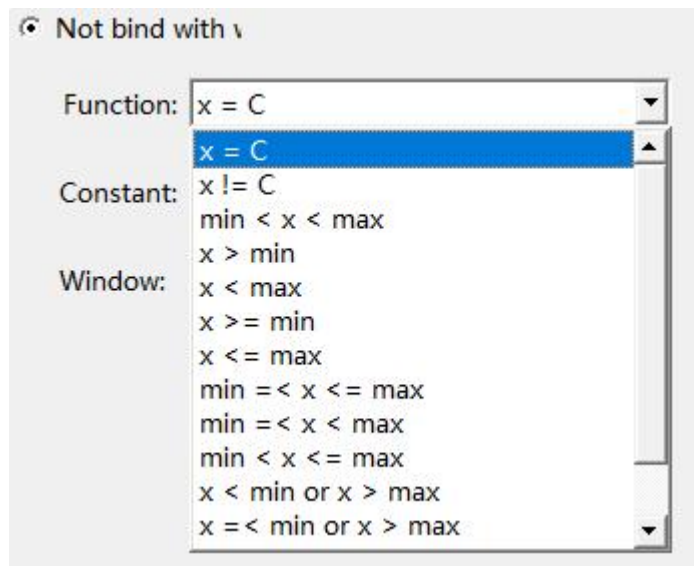

Figure 4-139

Refer to “Bit button” for the application of “Visibility” page.

After setting parameter of multi-window,click“ok”,drag mouse on Picture area window,and create a

rectangle area. The area would display the multi-window, as shown in figure 4-140.

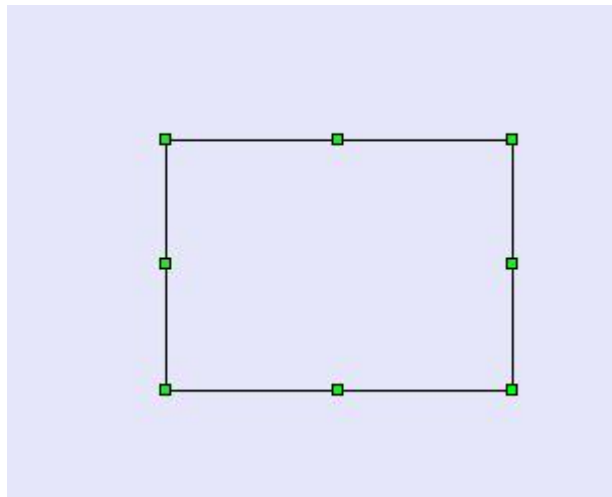

Figure 4-140



When creating a new window, "Top window" is defaulted, as shown below. It means that you cannot operate other screens or windows when this window pops up. So you should add a screen button on the window to close it.

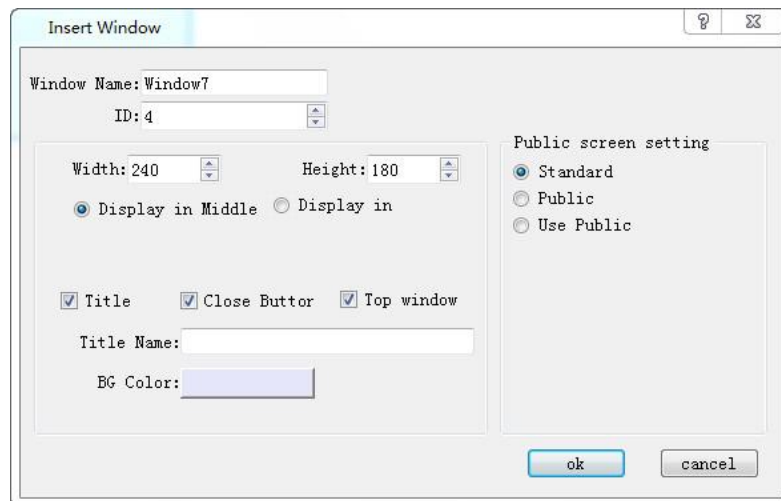

Figure 4-141 window property

## 6.6.16 Path display



The function of the control is to draw the corresponding graphic elements point, line, arc, circle, etc.

The relevant addresses used by this control are all internal registers LB or LW addresses

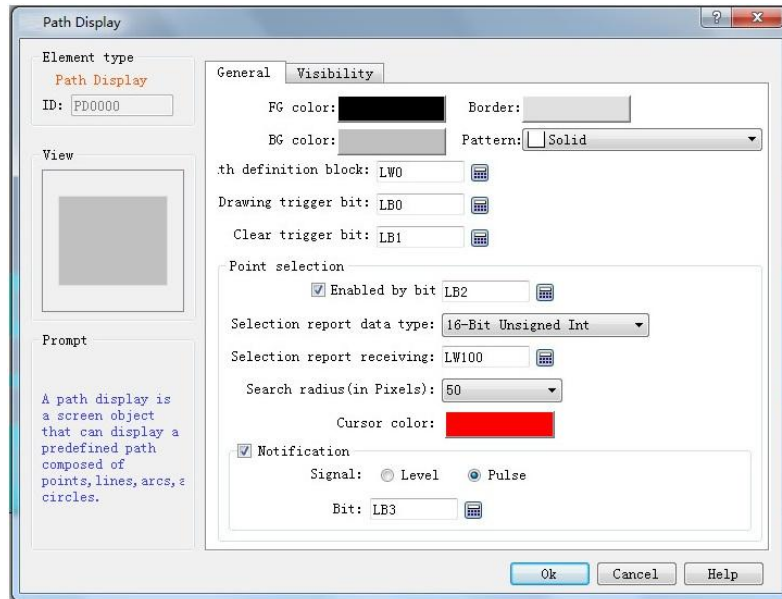

### Path display general dialog box

- Foreground color, border color, background color, Visibility style reference "bit button"
- Path definition area: path correlation element definition area, data specific meaning reference chapter finally "[path definition zone address description](#)"
- The drawing trigger bit: the address data of the bit address starts drawing, the address data is off
- Remove the trigger bit: the address data is cleared for on
- Select function: select the current drawing graph to display the relevant information
  - By bitability: whether to enable the selection function, the default address is off, and the selected function is enabled. The bits address data is on. close the selected function
  - Select report data type: select report data store type as needed
  - study report receiving area: set report receiving area for choosing store address, specific meaning refer to the last of this chapter "[report receiving area for choosing address](#)"
  - Search radius (pixel) : sets the search radius
  - Cursor color: sets the cursor color
- notice:
  - signal:

Position: enable the function of selecting points, select a point in the current drawing graph, this option will be triggered, and set the notification bit as the specified state. The notification bit shall be manually reset to normally monitor the status of subsequent notification of selecting points

Pulse: enable the function of selecting points, select a point in the current drawing graph, this option will be triggered, and set the notification bit to ON, and the notification bit will be automatically reset

Notification bit: sets the order and the address to be notified when the pulse function is triggered

**Path definition area address description :**

Path definition area: specify the drawing parameter address of the path display in the following format. Take the address LW0 address as an example. The data meaning is as follows







| Word number        | instructions  |
|--------------------|---|
| LW0                | The number of path elements in the path                     |
| LW1~LW8            | Information about the first path element in the definition  |
| LW9~LW16           | Information about the second path element in the definition |
| ...                | ...   |
| LW (8n-7) ~LW (8n) | The NTH path element in the definition                      |

Index of related elements: [point](#), [line](#), [arc](#), [circle](#), [thickness](#), [color](#)

point:

| Word    | Mnemonics | Describe              |
|---------|-----------|-----------------------|
| LW1     | type      | The point code is 0   |
| LW2     | color     | <a href="#">color</a> |
| LW3     | x         | X coordinate of point |
| LW4     | y         | Y coordinate of point |
| LW5~LW8 | (keep)    | Now is zero           |

line:

| Word | Mnemonics | Describe   |
|------|-----------|--|
| LW1  | type      | The code for the line is 1   |
| LW2  | color     | color  |
| LW3  | X1        | Starting point x coordinate  |
| LW4  | Y1        | Starting point Y coordinate  |
| LW5  | X2        | End point X coordinate   |
| LW6  | Y2        | End point Y coordinate   |
| LW7  | style     | Style type:<br>0: Don't show<br>1:  The solid line<br>2:  Dotted line<br>3:  Point, line<br>4:  Virtual - point line<br>5:  Virtual dot dot line<br>6 Or on the:  The solid line |
| LW8  | (keep)    | Now the 0  |

The circular arc (Draws counterclockwise from the start point to the end point) :

| Word | Mnemonics | Describe                    |
|------|-----------|-----------------------------|
| 0    | type      | The arc code is 2           |
| 1    | color     | color                       |
| 2    | X         | Center X coordinates        |
| 3    | Y         | Center Y coordinate         |
| 4    | X1        | Starting point X coordinate |
| 5    | Y1        | Starting point Y coordinate |
| 6    | X2        | End point X coordinate      |
| 7    | Y2        | End point Y coordinate      |

round :

| Word | Mnemonics | Describe             |
|------|-----------|----------------------|
| 0    | type      | The circle code is 3 |
| 1    | color     | color                |
| 2    | X         | Center X coordinates |
| 3    | Y         | Center Y coordinate  |
| 4    | r         | Circle radius        |
| 5~7  | (keep)    | Now is zero          |

The thickness of the (Affects subsequent elements until the next thickness appears) :

| Word | Mnemonics | Describe         |
|------|-----------|------------------|
| 0    | type      | Thickness code 8 |



|     |                      |                                 |
|-----|----------------------|---------------------------------|
| 1   | (keep)               | Now is zero                     |
| 2   | The thickness of the | Thickness of stroke.Unit: pixel |
| 3~7 | (keep)               | Now is zero                     |

The usual color value is :

| color        | The numerical (Hexadecimal data) |
|--------------|----------------------------------|
| black        | 0x0000                           |
| blue         | 0x0010                           |
| green        | 0x0400                           |
| cyan         | 0x0410                           |
| red          | 0x8000                           |
| magenta      | 0x8010                           |
| brown        | 0x8400                           |
| gray         | 0xc618                           |
| Dark grey    | 0x8410                           |
| Light blue   | 0x001f                           |
| Light green  | 0x07e0                           |
| Pale blue    | 0x07ff                           |
| pink         | 0xf800                           |
| Pale magenta | 0xf81f                           |
| yellow       | 0xffe0                           |
| white        | 0xffff                           |

#### Address description of the reception area of the selected report

| Word number | instructions   |   |
|-------------|--|---|
| 0           | Select the X coordinate of the point                               |   |
| 1           | Select the Y coordinate of the point                               |   |
| 2           | Click the element, where the sequence number of the selected point |   |
| 3           | value  | describe  |
|             | 0  | Dot: a dot<br>Line: the starting point of a line<br>Circle: the center of a circle<br>Arc: the starting point of an arc |
|             | 1  | Line: the end point of a line<br>Arc: the point at which an arc ends  |

## 6.6.17 Scroll bar



The scroll bar is a control that is used to see the data of the table class control, which is convenient for users to browse the table data quickly. Only the following controls are supported only: alarm display, historical alarm display, formula data display, historical data display, operating log display

The control is used for the associated controls to display too much data, unable to display the complete situation once, and can be used to display the remaining part of the data



The control is on the toolbar , Click the icon to pop up the dialog box below :

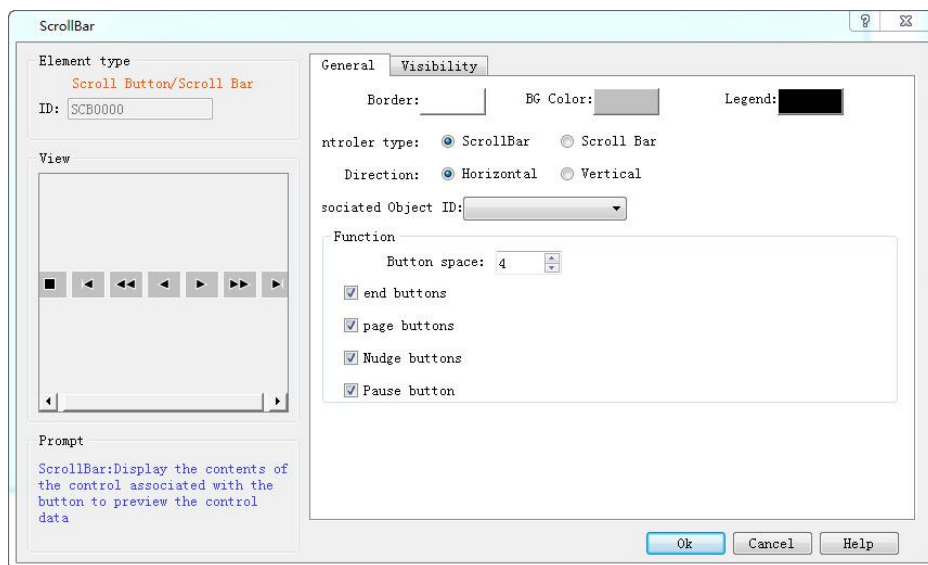

Scroll bar dialog box

The control function is described in detail below (the control is mainly divided into two categories: scroll buttons and scroll bars)

Scroll bar: control table data refresh in a scroll bar

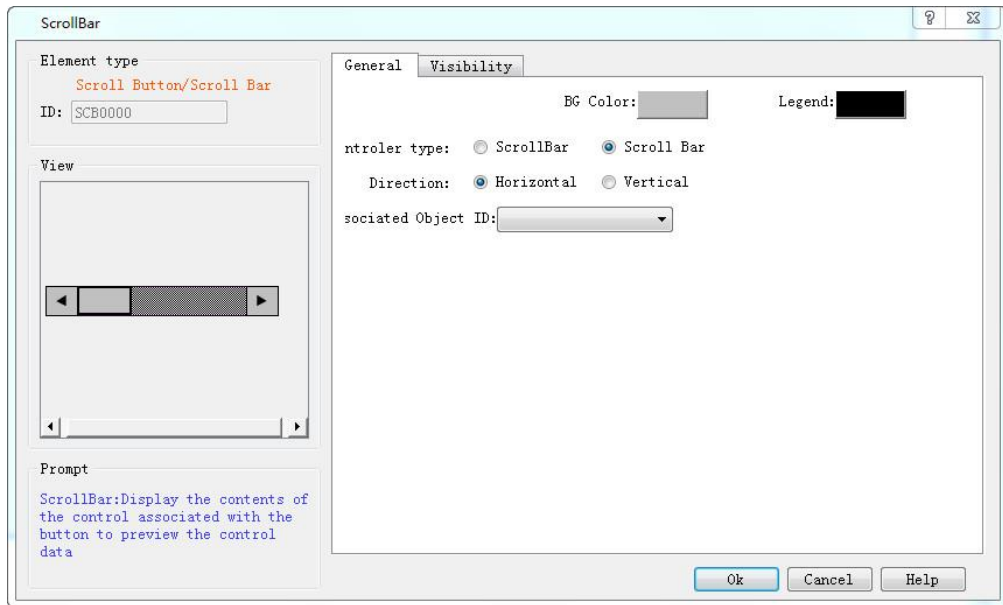

Background color: setting control background color

Symbol color: set the control symbol color

Direction: set the scroll bar control to control the direction of the table data

Level: control table horizontal data display

Vertical data display control table

The associated object number, the current page exists in any of the controls mentioned in the previous section, can be associated with the corresponding control to achieve the effect of the control. If the current page does not have any of these controls, the error message will be prompted. "the associated object cannot be empty. The object number is the data in the upper left corner number of the control.

Take the historical data display as an example, which is the effect of the scroll bar control

There are 75 data in the current historical data display, and the historical data display and the scroll bar are all at the bottom

|    | Time     | Date     | AA | AA1 | AA2 | AA3 |
|----|----------|----------|----|-----|-----|-----|
| 71 | 16:47:46 | 24/07/19 | 0  | 0   | 0   | 0   |
| 72 | 16:47:47 | 24/07/19 | 0  | 0   | 0   | 0   |
| 73 | 16:47:48 | 24/07/19 | 0  | 0   | 0   | 0   |
| 74 | 16:47:49 | 24/07/19 | 0  | 0   | 0   | 0   |
| 75 | 16:47:50 | 24/07/19 | 0  | 0   | 0   | 0   |

Move the scroll bar to the middle position, and the data display is shown as shown below :

|    | Time     | Date     | AA | AA1 | AA2 | AA3 |
|----|----------|----------|----|-----|-----|-----|
| 71 | 16:47:46 | 24/07/19 | 0  | 0   | 0   | 0   |
| 72 | 16:47:47 | 24/07/19 | 0  | 0   | 0   | 0   |
| 73 | 16:47:48 | 24/07/19 | 0  | 0   | 0   | 0   |
| 74 | 16:47:49 | 24/07/19 | 0  | 0   | 0   | 0   |
| 75 | 16:47:50 | 24/07/19 | 0  | 0   | 0   | 0   |

Scroll button: button mode control table data refresh

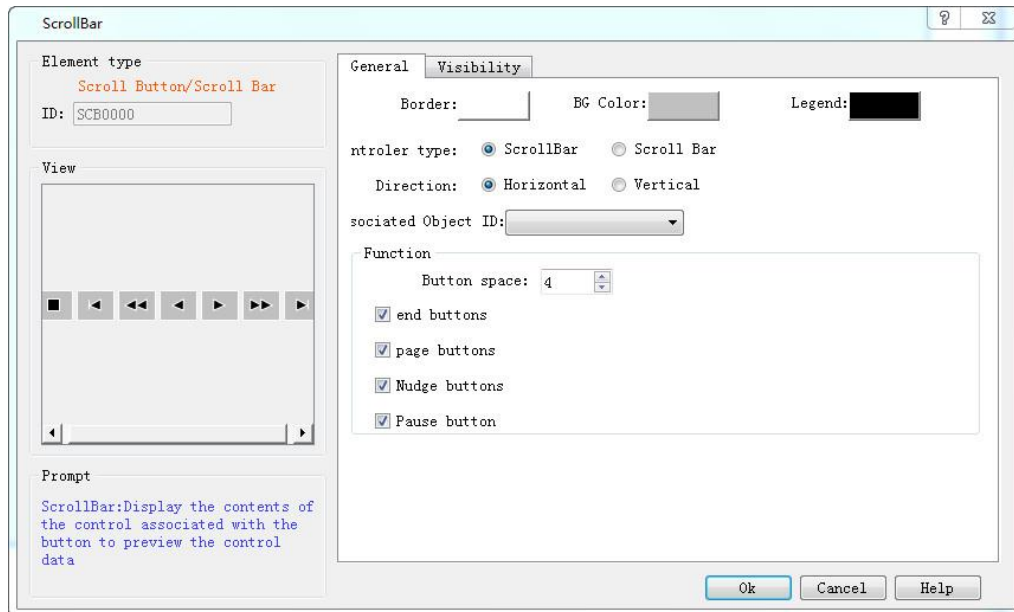

Border color: set the border color of the control

Background color: setting control background color

Symbol color: set the color of the symbol in the control

direction

Level: control table level data display

Vertical: control table vertical mode data display

Associated object number: reference to the previous description

## Function key

The button interval, the spacing between the buttons

To the end/to the end: the mobile table data is at the start or end, as with the following two buttons, when the data is already in the starting or end location, and the click button will pop-up the dialog box prompt operation is invalid

Page/page/page/left page/right: move a page of pages each time

Top/down or left/right: move a data in the corresponding direction each time

Pause: if the current table data is in a changing state, clicking this button can stop the table data changes and again click back to the original state. If the current direction of the table is fixed, it will not change, click the button prompt, and the function is invalidTake the historical data display as an example, and the image below is the effect of the scroll button control

The current historical data display has 71 data

|    | Time     | Date     | AA | AA1 | AA2 | AA3 |
|----|----------|----------|----|-----|-----|-----|
| 71 | 16:47:46 | 24/07/19 | 0  | 0   | 0   | 0   |
| 72 | 16:47:47 | 24/07/19 | 0  | 0   | 0   | 0   |
| 73 | 16:47:48 | 24/07/19 | 0  | 0   | 0   | 0   |
| 74 | 16:47:49 | 24/07/19 | 0  | 0   | 0   | 0   |
| 75 | 16:47:50 | 24/07/19 | 0  | 0   | 0   | 0   |

If you click the stop button during the program runtime , Stop the table refresh and pop up the following dialog





Click the stop button again , Refresh the table and pop up the following dialog





When you click the button , The historical data display data is changed as shown below, and the data

jumps to the beginning. Again, if you click on the tail button , Data jump to the end

|   | Time     | Date     | AA | AA1 | AA2 | AA3 |
|---|----------|----------|----|-----|-----|-----|
| 1 | 17:22:02 | 24/07/19 | 0  | 0   | 0   | 0   |
| 2 | 17:22:03 | 24/07/19 | 0  | 0   | 0   | 0   |
| 3 | 17:22:04 | 24/07/19 | 0  | 0   | 0   | 0   |
| 4 | 17:22:05 | 24/07/19 | 0  | 0   | 0   | 0   |
| 5 | 17:22:06 | 24/07/19 | 0  | 0   | 0   | 0   |

When you click the next page button , The historical data display is changed in the following diagram, the current historical data display, a page of up to 5 Numbers, and the historical data display displays the next 5 Numbers when the next page button is clicked. Again, click on the front page button , Show the number of five Numbers

|    | Time     | Date     | AA | AA1 | AA2 | AA3 |
|----|----------|----------|----|-----|-----|-----|
| 6  | 17:22:07 | 24/07/19 | 0  | 0   | 0   | 0   |
| 7  | 17:22:08 | 24/07/19 | 0  | 0   | 0   | 0   |
| 8  | 17:22:09 | 24/07/19 | 0  | 0   | 0   | 0   |
| 9  | 17:22:10 | 24/07/19 | 0  | 0   | 0   | 0   |
| 10 | 17:22:11 | 24/07/19 | 0  | 0   | 0   | 0   |

When you click on the button , The historical data display is shown in the following diagram, showing the number of 1 in the top, and the same thing, when you click on the button , The bottom shows a number of data

|   | Time     | Date     | AA | AA1 | AA2 | AA3 |
|---|----------|----------|----|-----|-----|-----|
| 5 | 17:22:06 | 24/07/19 | 0  | 0   | 0   | 0   |
| 6 | 17:22:07 | 24/07/19 | 0  | 0   | 0   | 0   |
| 7 | 17:22:08 | 24/07/19 | 0  | 0   | 0   | 0   |
| 8 | 17:22:09 | 24/07/19 | 0  | 0   | 0   | 0   |
| 9 | 17:22:10 | 24/07/19 | 0  | 0   | 0   | 0   |

## 6.6.18 Pipeline



The function of the control is to set the line diameter according to the set location of the specified control

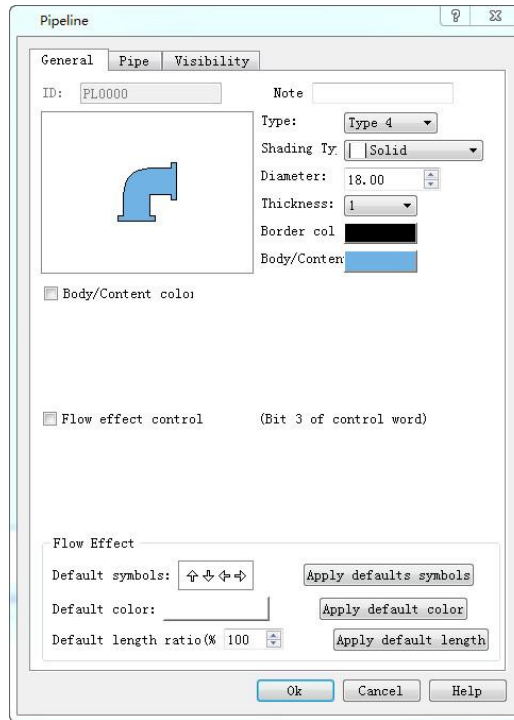

Pipeline general dialog

Style: set line display style, style has the following several effects, display effect reference "[style](#)"

Gradual layer: setting up the line of the pipeline to display the effect, the layer has the following results, the display effect is refer to the "[gradual layer](#)"

Diameter: the diameter of the pipeline is set, which is used to change the diameter of the pipeline "[diameter](#)".

Thickness: the thickness of the pipeline is set, and the thickness of the pipe is added on the basis of the diameter of the pipeline. The effect is referenced "[thickness](#)"

Edge: the color of the pipeline thickness is set, which is the color of the pipeline edge when the pipeline thickness is 0

Pipe wall/content: set the line main display color

Wall/content color variable

Body/Content color View color #1

Body/Content color  (Bit 0 of control w

Body/Content color  (Bit 1 of control w

Blink control (Bit 2 of control word)

See color: when the pipe wall/content color variable function is enabled, the line displays the color, the color content is selected from the pipe wall/content, tube wall/content color # 2, tube wall/content color # 3, which is only shown in the configuration software, and the position control of the color controlled word is displayed in the actual operation

Tube wall/content color # 2, tube wall/content color # 3: set the different colors of the line

Scintillation control: control the line flashing

Flow control:

Control word: word, double word

Flow effect: (note that only after the pipe page is set to enable the flow effect of the pipe, the following types can be applied to the pipes that enable the flow effect).

Preset type: setting pipe flow effect

Default color: set the flow color of the pipe

The preset length ratio is (7) : the length ratio of the pipe is set

All use the preset type, color, and length: choose to apply a type to all the pipes that enable the flow effect of the pipe page

Control word:

Flow effect control (Bit 3 of control word)

Control Word

Size:  Word  Double-Word

Address:  

The user enables the control of the tube wall/content color variable and the effect control of the effect of the effect control, which is different from the different display effect of a control control of the selected register.

Take lw0 as an example

| register | No. 0 | No. 1 | No. 2 | No.3 | No. 4 | No. 5 | No. 6 | No. 7 |
|----------|-------|-------|-------|------|-------|-------|-------|-------|
|----------|-------|-------|-------|------|-------|-------|-------|-------|



|  |   |   |   |                  |           |           |           |           |
|--|---|---|---|------------------|-----------|-----------|-----------|-----------|
| LW0<br><br>( The<br><br>correspondin<br>g bit is on<br>on) | Set the<br>tube wall<br>color<br>Tube<br>wall/content<br>t color #3 | Set the<br>tube wall<br>color<br>Tube<br>wall/content<br>t color #3 | Line<br>flashing<br>The current<br>two are on<br>or offColor<br>is the color<br>of the tube<br>wall/content<br>t set<br>The current<br>two are<br>only set up<br>one time,<br>the line<br>color is<br>inThe<br>pipeline<br>content is<br>switched<br>between<br>the pipeline<br>content # | Pipeline<br>flow | retention | retention | retention | retention |
|--|---|---|---|------------------|-----------|-----------|-----------|-----------|

Pipe setting interface:

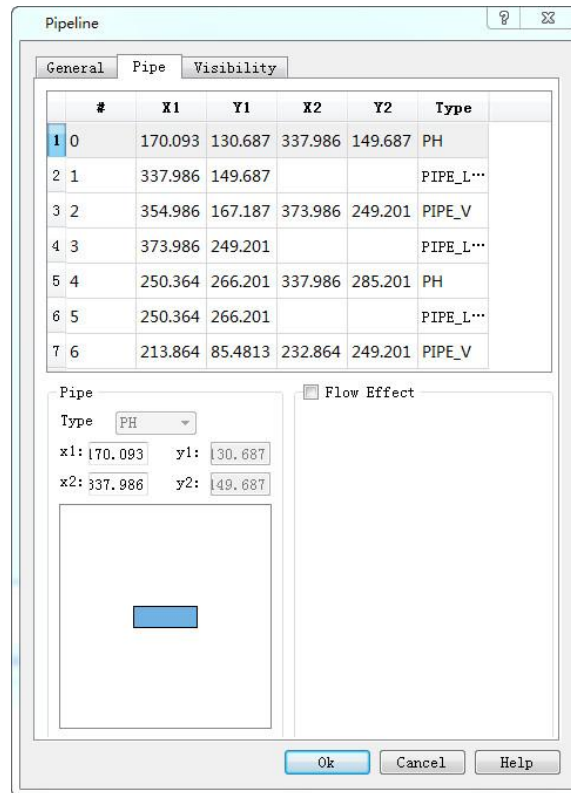

Pipe setting interface

X1, Y1, X2, Y2:

The coordinate point of the pipe, the left coordinate (x1,y1), the right coordinate (x2, y2).

The user can modify the tube coordinate, need to be careful, the transverse tube can only modify the x coordinate, the longitudinal tube can only modify the y coordinate, the Angle coordinate cannot be modified, but can modify the Angle coordinate style type.

Flow effect: the user can set up each pipe to display different kinds of flow effect, display color, length ratio, etc.

If the user USES the same type of display effect, you can only enable the flow effect here, using all the preset functions in the general interface, and can be applied to the current control for all the pipes that start the flow effect.

The display interface is the same as his control, which can refer to the "bit switch" display page.

style:

style 1

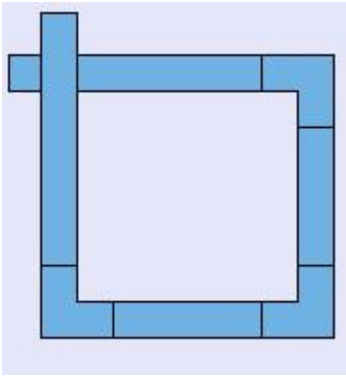

style2

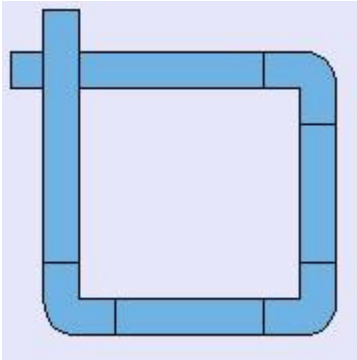

style3

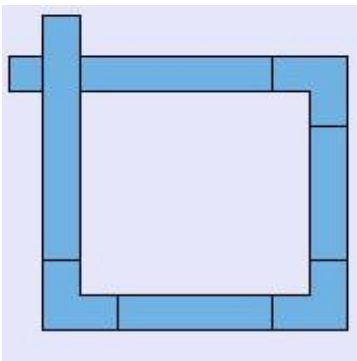

style 4

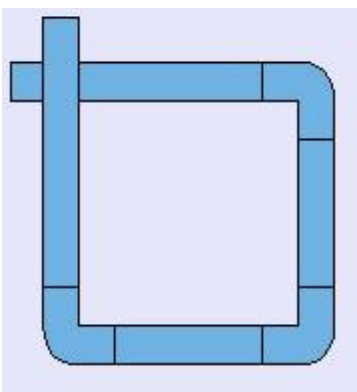

style 5

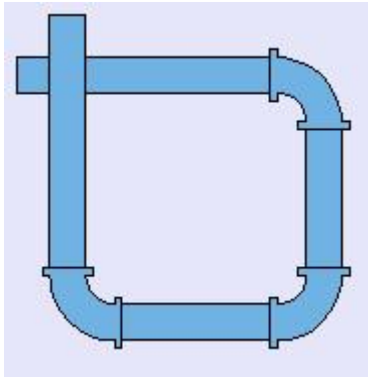

Gradual layer:

Pure color

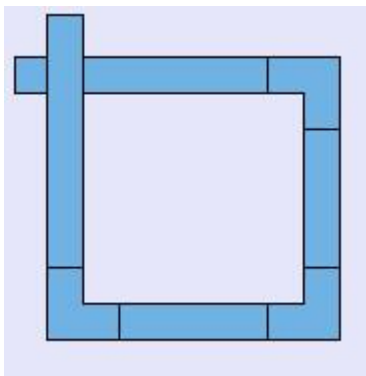

Three-dimensional

style1

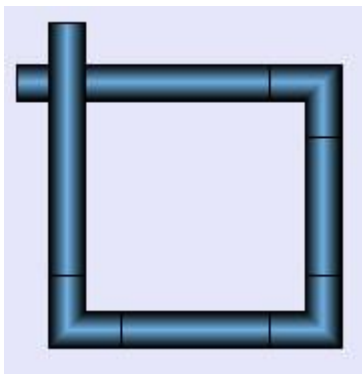

Three-dimensional

style 2

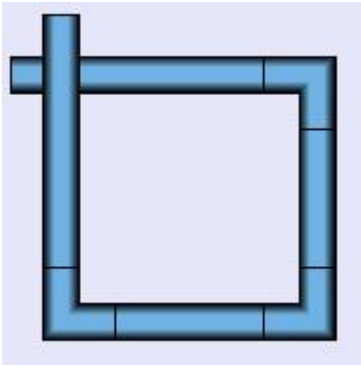

Three-dimensional

style 3

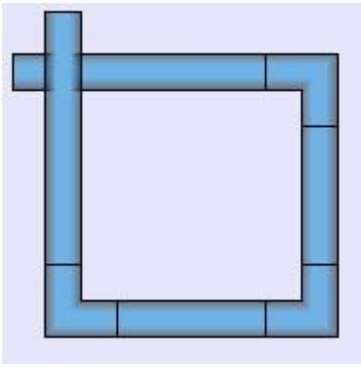

diameter:

diameter10

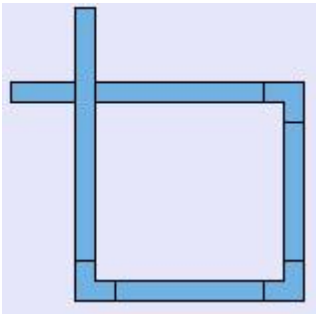

diameter 20

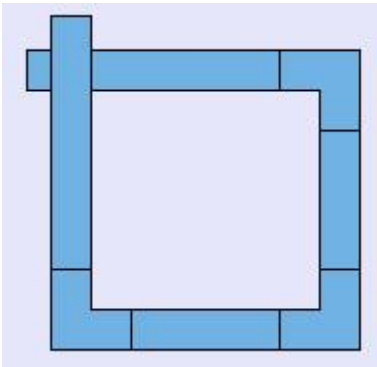

diameter 30

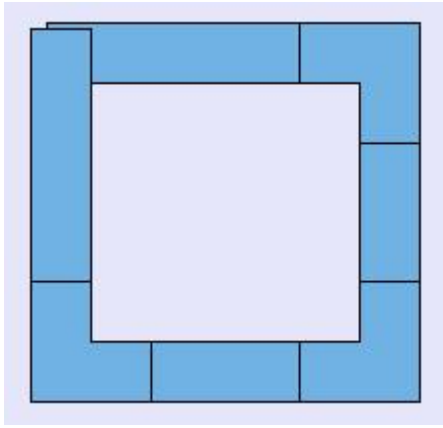

thickness:

thickness 0

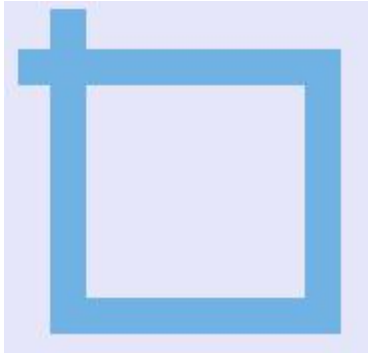

thickness 1

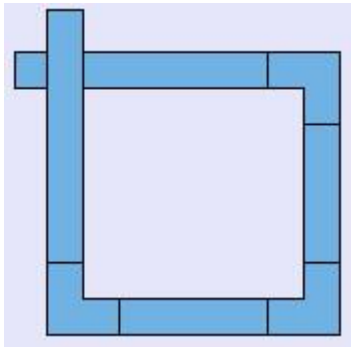

thickness 4

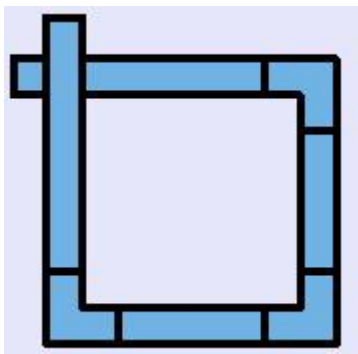

thickness 8

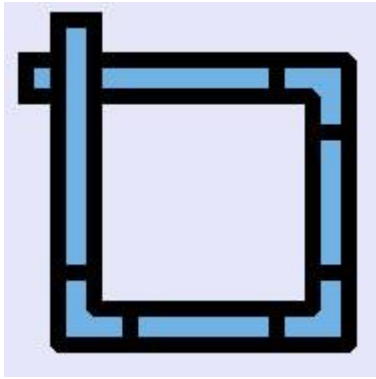

## 6.6.19 Dial

This control expands the functions of the meter control, mainly adding more dial styles, and can set the alarm range.

General page for dials

- Dial styles: support custom styles and preset styles. preset styles are like these:

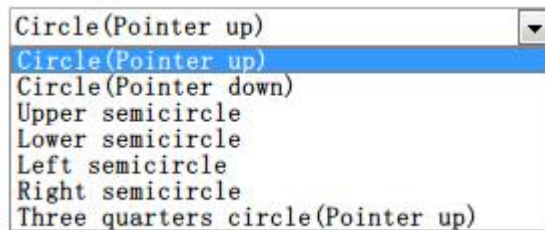

Custom styles: we can customize the angle of the dial like this:



Note: There is a range limitation. The starting angle is between  $[-360, 360]$  and the ending angle is between  $[\text{starting angle}, \min(\text{starting angle} + 360, 360)]$ ,

where min represents the minimum of the two.

- Unlike the meters, the dials can set dial pictures:

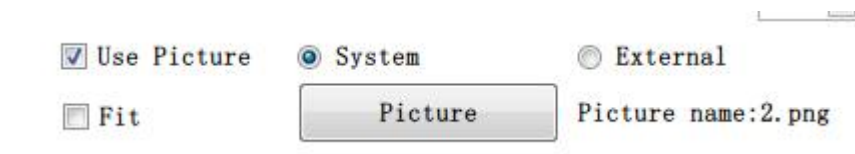

There are two ways to set dial picture after selecting "Use Picture", one is to select the system picture:

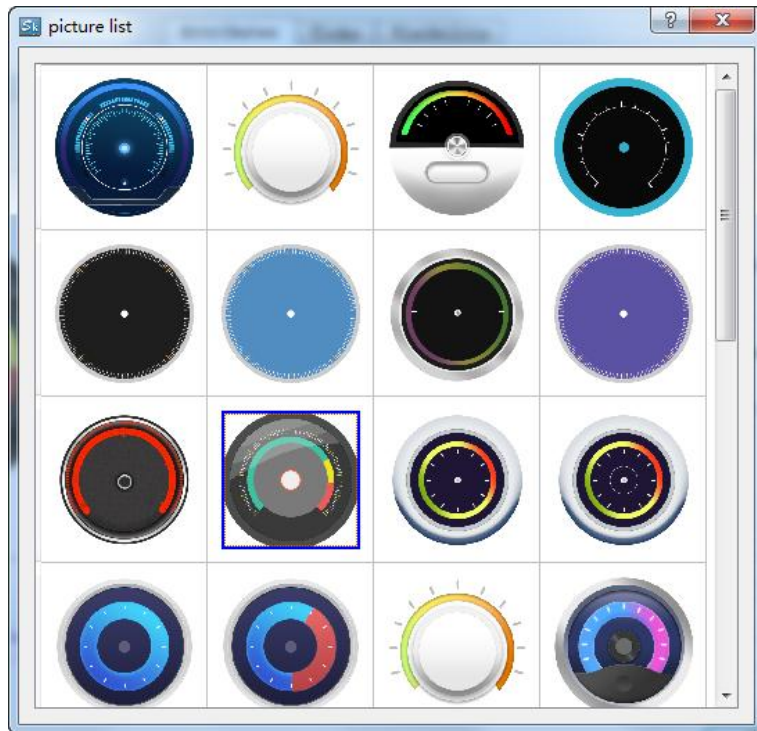

select a picture and click to set it on the dial. The other is to select the external picture:

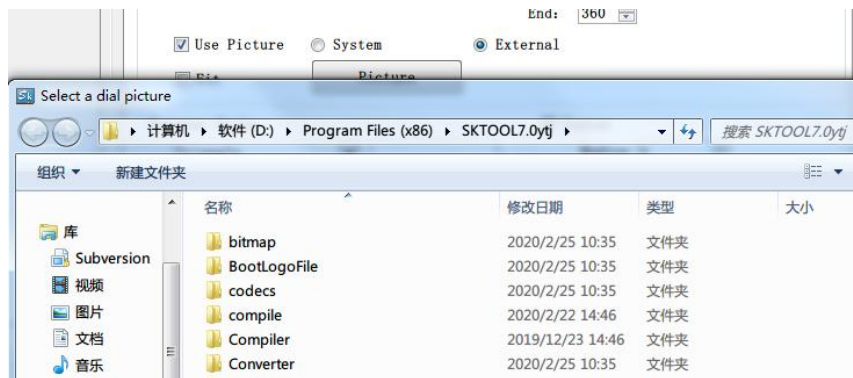

users can select pictures in the specified directory.



Fit to the dial size : mainly used in conjunction with the dial style, the selected picture will be cropped to the dial size when checked.

➤ Pointer styles



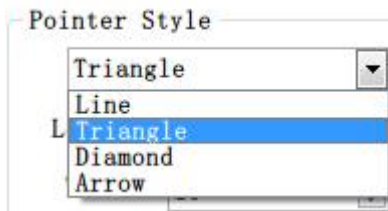

support four styles,

we can custom the length, width and color of pointer.

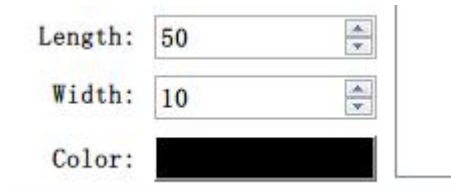

➤ Center

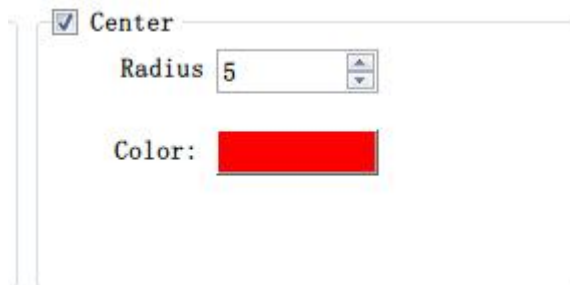

Check to display the center of the dial(equivalent to the base of the meter), adjust the size of the center by "Radius". We can also adjust the color of the center by "Color".

- Data type: Choose different data types according to their needs.
- Monitor address: Read the address value that is shown by the pointer on the dial plate.
- Maximum: Set the maximum value that cannot be exceeded by the monitor address value, check



this to set a dynamic value.

- Minimum: Set the minimum value that the monitor address value cannot be lower than, check this



to set a dynamic value.

2.Click the "Ticks" page to set the tick properties as shown:

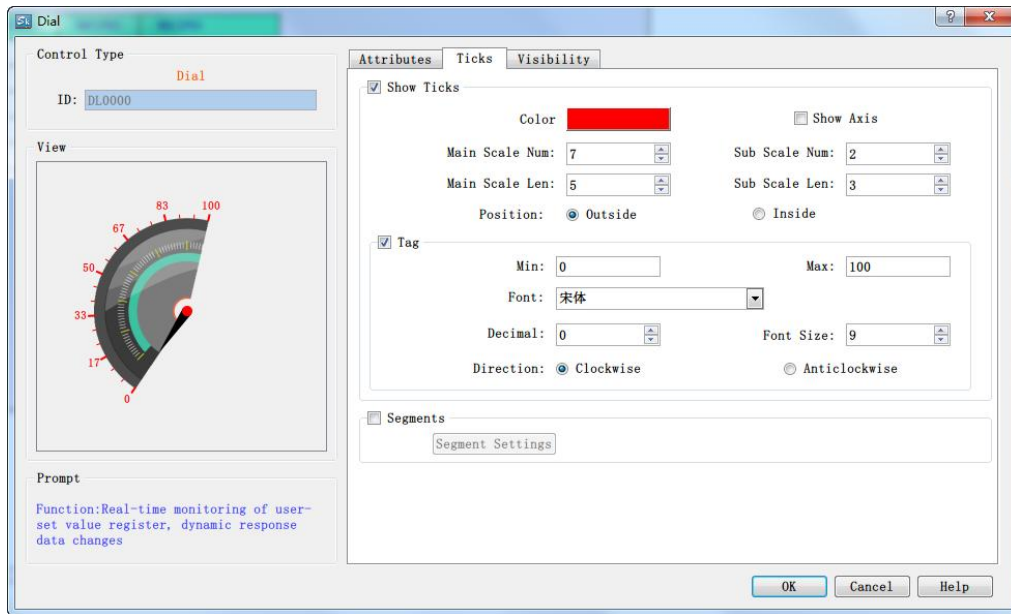

### "Ticks" page

On this page, users can set the color of the ticks, the number of main scales, the number of sub scales, whether to display the axis and whether to display the scale tags and other options.

### ➤ Scale

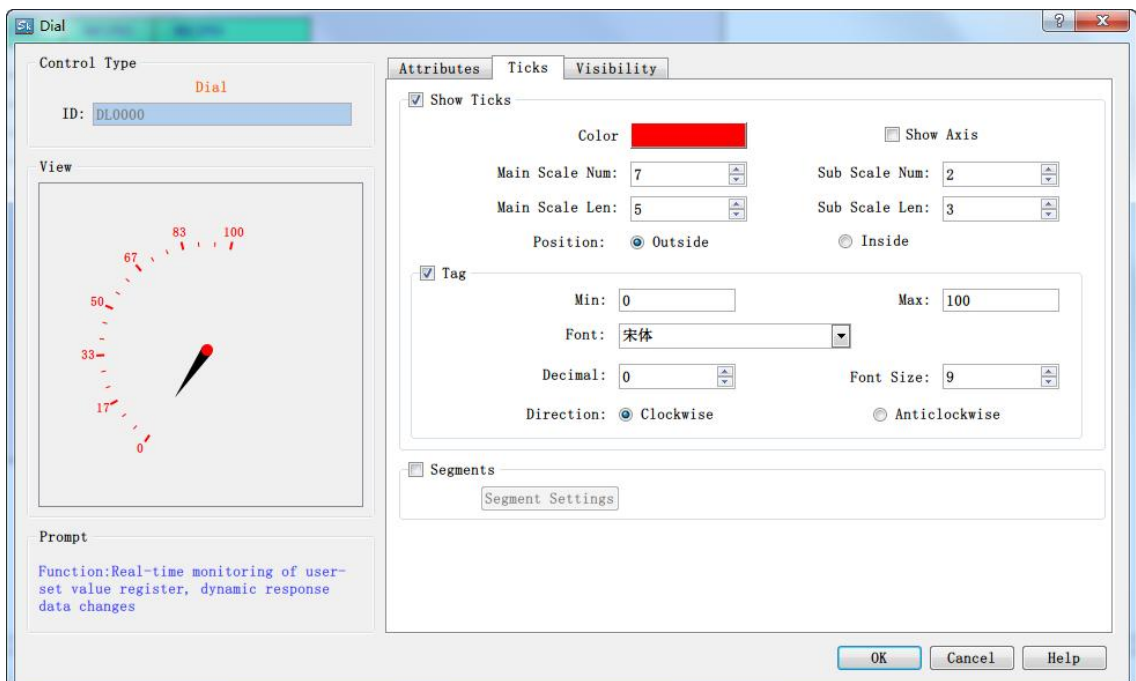

Check "Show Ticks" will draw a scale line on the edge of the dial, and check "Show Axis" will display the dial circumference. Set the number of scale lines

displayed on the dial by "Main Scale Num"/"Sub Scale Num", and modify the length of the scale lines by "Main Scale Len"/"Sub Scale Len".

If you choose "Outside", the scale and the scale tags will be drawn outside the scale axis, otherwise, they will be drawn inside the axis.

Check "Tag" to display the scale value. Set the scale range by "Min" and "Max", and set the scale display style by "Font" and "Font Size". The tags support decimals, which can be achieved by setting "Decimal".

Modify the display direction of the scale by setting "Direction".

- Segment setting: check "segments" the dial will be divided into three segments according to the scale, and displayed in different colors.

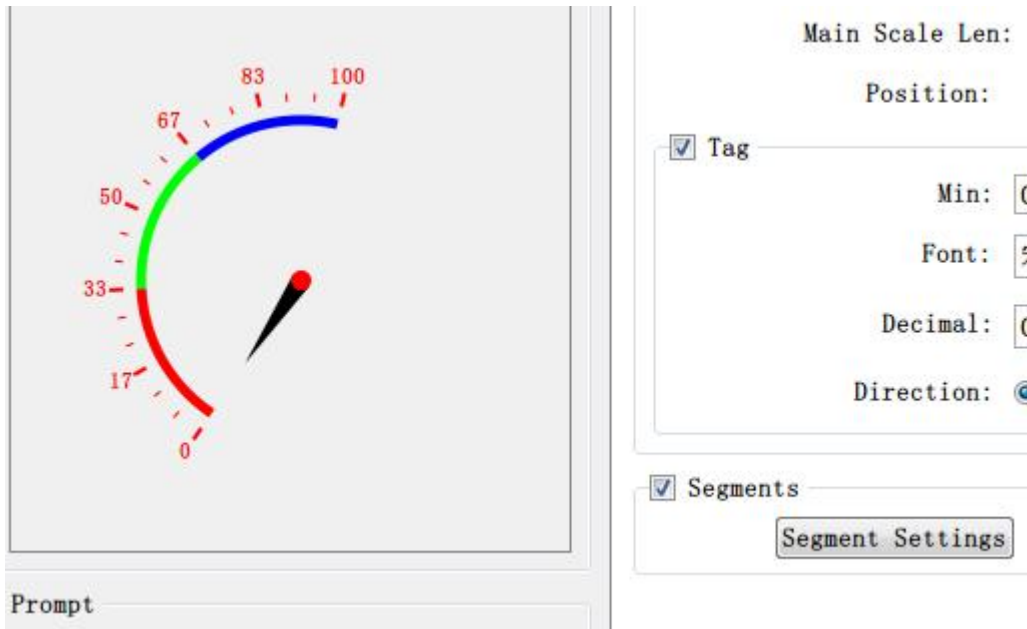

Click "Segment Settings" to enter the "Segment Settings" page:

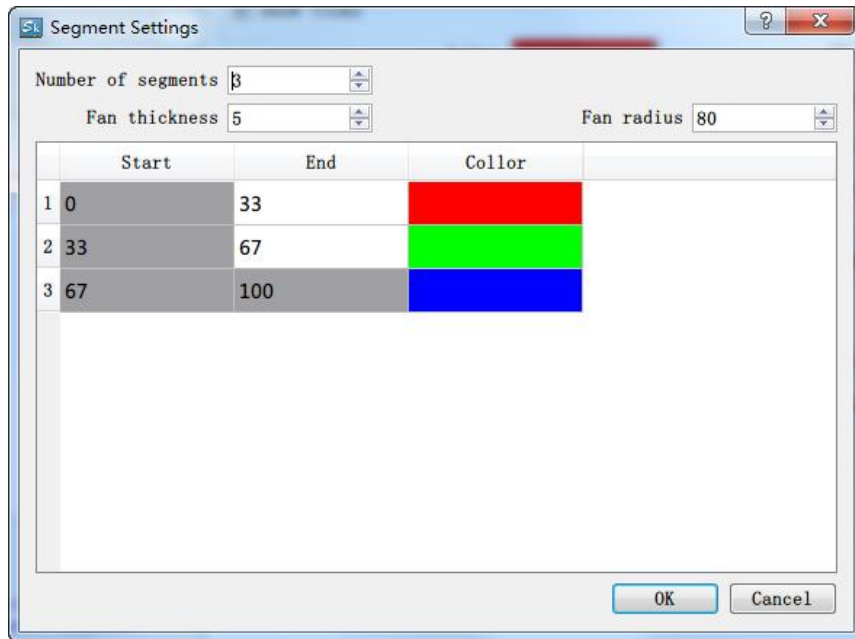

Users can set up to 5 segments at most. Modify the fan width by "Fan Thickness" and modify the position by "Fan Radius".



Double-click the end scale

|   | Start | End | Collor |
|---|-------|-----|--------|
| 1 | 0     | 20  | Red    |
| 2 | 20    | 40  | Green  |
| 3 | 40    | 60  | Blue   |
| 4 | 60    | 80  | Cyan   |
| 5 | 80    | 100 |        |

to modify the range of each

segment.

Click the color to set the color of each segment.

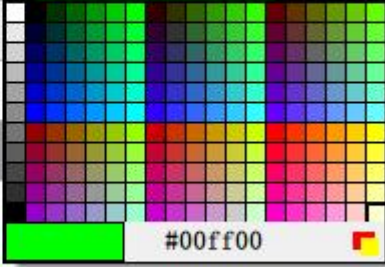
|   | Start | End | Collor   |
|---|-------|-----|--|
| 1 | 0     | 20  |  |
| 2 | 20    | 40  |  |
| 3 | 40    | 60  |  |
| 4 | 60    | 80  |  |
| 5 | 80    | 100 |  |

3. In the screen editing area click to draw the control. The effect diagram of the dial control is as follows:

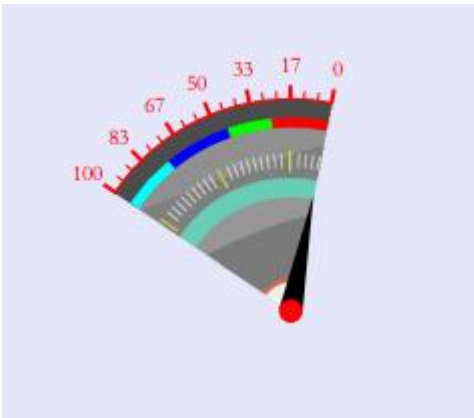

Dial control

4. Select the dial control graph, move the mouse on the 8 small green dots to modify its size; double-click to re-modify the control properties.



Dial control has a fixed aspect ratio; if modify the size, its length and width enlarge or shrink in the meantime. The "Visibility" page can refer to that of "Bit Button" control.

## 6.7 SKTOOL Control Instructions



SKTOOL configuration software provides full-featured basic controls. Users can double-click or right-click the

control in the view area to set the properties. The position and size of controls can be modified manually in the status bar below or directly drag the mouse.

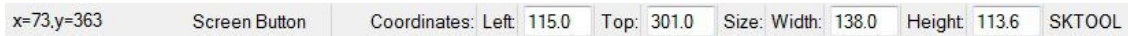

Address input of controls: It is available to input an address directly through a keyboard when it needs to operate on the PLC address. The address name is case-insensitive.

Status combo box: In the toolbar, there is a combo box where to display and change the state of bit button, bit indicator, multi-state button, multi-state indicator, graphics move, message display and picture display.

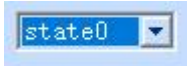

When a control of the above type is selected, its current state is displayed in the status combo box that users can pull down to change the current state.

Address Search: Query the use of an address and list the information of control occupying this address; double-click the information item to select the control.



Enter the address and select "Find", then the information output window will list the search results:

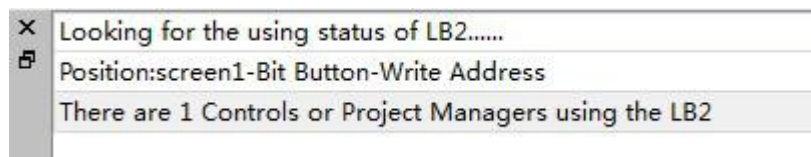

Choose the search result and double-click to select the control occupying the address currently.

Address Display: Click the "Address Display" to show the list of addresses used by the configuration project; double-click a message, then it will pop up the property page of control using this address so as to set the property settings easily and quickly.

| Display Address Use |             |   |              |
|---------------------|-------------|---|--------------|
|                     | Screen Name | Control name                              | Address Used |
| 1                   | Screen5     | Corner flow block -Trigger address        | LB0          |
| 2                   | ProjManager | Historical data collector - write address | LW0          |
| 3                   | ProjManager | Historical data collector - write address | LW1          |
| 4                   | ProjManager | Historical data collector - write address | LW2          |
| 5                   | ProjManager | Historical data collector - write address | LW3          |
| 6                   | ProjManager | Historical data collector - write address | LW4          |
| 7                   | ProjManager | Historical data collector - write address | LW5          |
| 8                   | ProjManager | Historical data collector - write address | LW6          |
| 9                   | ProjManager | Historical data collector - write address | LW7          |
| 10                  | ProjManager | Historical data collector - write address | LW8          |
| 11                  | ProjManager | Historical data collector - write address | LW9          |
| 12                  | ProjManager | Historical data collector - write address | LW0          |
| 13                  | ProjManager | Historical data collector - write address | LW1          |

Visible Type

Display all windows       Display the window

Display register

In the Display Mode, you can specify the selected address information or display all the screens.

Overlay of control: You can execute multiple controls by one operation through stacking controls. SKTOOL supports stacking up to 32 controls. When multiple controls are overlaid and touched, the corresponding operations are performed in the order in which they are superimposed, as shown in Figure below:

Superimposing the control 1, 2 and 3, after the touch, execute in turn the command 1, 2 and 3.

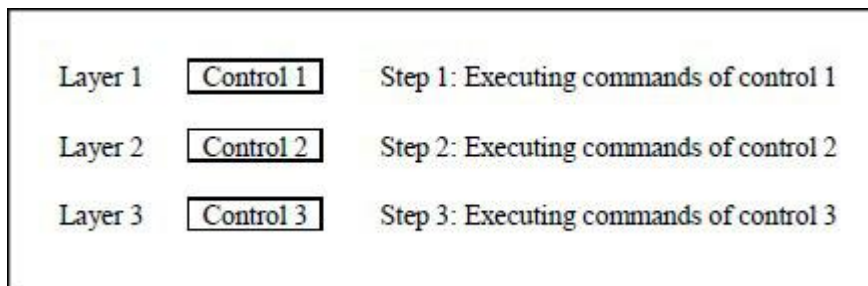

If there is a screen switch button in the overlaid control, it will switch the screen when it comes to the turn of this command. The superimposed button commands that are after the screen button will not be executed. Similarly, if there is a pop-up input keyboard, it will pop up a keyboard while without executing the after commands.

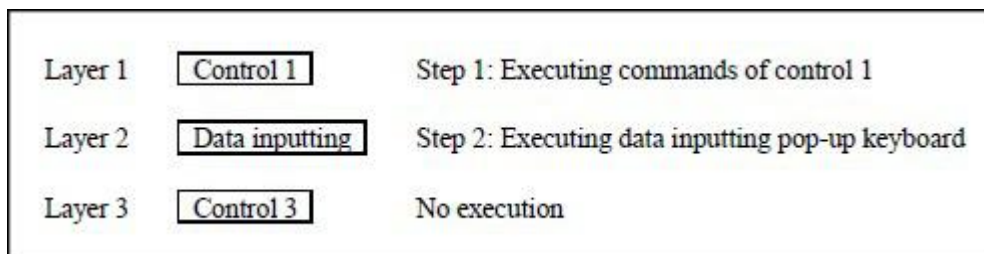

---

## 7. Script

### Script



Script is an advanced control method for touch screen, which provides more strong functions for touch screen. Through programming for script command, the touch screen is given the same functions as logic and arithmetic operation with PLC. Using the macro flexibly is capable to achieve many strong functions that are unavailable for conventional components and to perfect the human-computer interface more.

SKTOOL provides new full scripts that are different from the script language mode of other human-computer interfaces, and these scripts are compatible with standard C Language (ANSI C89). As there are many literatures about C Language and this information are available easily, this chapter will not introduce syntax and basic knowledge in details to review the relevant basis of different macros but emphasize the establishment and usage of macros by instances.

This chapter will explain basic C Language briefly, relevant usage of script instruction and considerations.

#### Contents:

- [Introduction to C language](#)
- [C language programming preliminary](#)
- [scripts function introduction](#)



---

## 7.1 Introduction to C language

---

- [Data type of C language](#)
- [Initial value of variable and type conversion](#)
- [One-dimensional array](#)
- [Basic operator and expression](#)
- [Section summary](#)

### 7.1.1 Data type of C language

---

#### 1. Integer

Integer includes integer constant and integer variable. The integral constant is the integer constant. In C language, there are three kinds of integer constant: octal, hexadecimal and decimal.

#### 2. Integer constant

##### 1. Octal integer constant

The octal integer constant must begin with 0. That is to say, 0 is the prefix of octal integer constant. Its value is 0-7. Octal constant is usually unsigned. The followings are the legal octal:

015 (decimal:13) 0101 (decimal:65) 0177777 (decimal:65535)

The followings are the illegal octal:

256 (without prefix 0) 03A2 (contained non-octal codes) -0127 (with negative sign)

##### 2. Hexadecimal integer constant

The hexadecimal integer constant is prefixed with 0X or 0x. Its value is 0-9, A-F or a-f.

The followings are the legal hexadecimal:

0X2A (decimal:42)    0XA0 (decimal:160) 0XFFFF (decimal: 65535)

The followings are the illegal hexadecimal:

5A (without prefix 0X)    0X3H (contained non-hexadecimal codes)

### 3. Decimal integer constant

The octal integer constant has no prefix. Its value is 0-9.

The followings are the legal decimal: 237    -568    65535    1627

The followings are the illegal decimal:

023 (prefix 0 is forbidden)                  23D (contained non-decimal codes)

In the program, these notations are distinguished by prefix. Therefore, do not mistake the prefix in writing to avoid incorrect result.

3. When the suffix of integer constant is on the 16-bit computer, its basic integer is 16-bit. Therefore, the indicated figure value is limited. The decimal unsigned constant is within 0 ~ 65535, and the signed range is -32768 ~ +32767. The unsigned octal number is ranged within 0 ~ 0177777. The unsigned hexadecimal number is within 0X0 ~ 0XFFFF or 0x0 ~ 0xffff. If the figure is beyond the above range, it must indicate with long integer. The long integer is suffixed with "L" or "l".

For example:

Decimal long integer constant    158L (decimal: 158)    358000L (decimal: -358000)

Octal long integer constant    012L (decimal: 10)    077L (decimal: 63)    0200000L (decimal: 65536)

Hexadecimal long integer constant    0X15L (decimal: 21)    0XA5L (decimal: 165)    0X10000L (decimal: 65536).

There is no difference between long int 158L and basic int constant 158. As 158L is the long integer, C compiling system will assign 4-bit space for storage. As 158 is the long integer, C compiling system will assign 2-bit space for storage. Therefore, pay attention to operation and output format to avoid mistakes. The unsigned number can be indicated with suffix. The unsigned number of integer constant is suffixed with "U" or "u". For example: 358u, 0x38Au, 235Lu are the unsigned number. Use prefix and suffix together to

indicate different figures. For example, 0XA5Lu indicates the hexadecimal unsigned long int A5 and the corresponding decimal is 165.

### 3. Integer variable

The integer variable can be classified as following:

#### 1. Int

Its type specifier is int, which occupies 2 bytes in the memory. Its value is always basic integer.

#### 2. Short int

Its type specifier is short int or short. The occupied bytes and value range is same to basic int.

#### 3. Long int

Its type specifier is long int or long, which occupies 4 bytes in the memory. Its value is always long integer.

#### 4. Unsigned int

Its type specifier is unsigned.

The unsigned int can be integrated with the above three types:

(1) The type specifier of unsigned int is unsigned int or unsigned.

(2) The type specifier of unsigned short int is unsigned short.

(3) The type specifier of unsigned long int is unsigned long.

All unsigned int occupies the same memory bytes with the signed int. As the sign bit is omitted, it can not indicate the negative number. The following table lists the assigned memory bytes and number range of various integers in ARM.

| Type Specifier | Number Range                           | Assigned Bytes       |
|----------------|--|----------------------|
| Int            | -2147483648~2147483647                 | ■ ■ ■ ■              |
| Short int      | -2147483648~2147483647                 | ■ ■ ■ ■              |
| Signed int     | -2147483648~2147483647                 | ■ ■ ■ ■              |
| Unsigned int   | 0~4294967295                           | ■ ■ ■ ■              |
| Long int       | -922337203685477808~922337203685477807 | ■ ■ ■ ■ ■ ■ ■ ■<br>■ |
| Unsigned long  | 0~18446744073709551615                 | ■ ■ ■ ■ ■ ■ ■ ■<br>■ |

#### 4. Integer variable declaration

The general form of variable declaration: type specifier, variable name identifier, .... Take examples as following:

```
int a,b,c;    (a,b,c is integer variable)
```

```
long x,y;    (x,y is long integer variable)
```

```
unsigned p,q;    (p,q is unsigned integer variable)
```

Announcements in writing variables should be paid attention as following:

1. Several same type of variables can be allowed to indicate after the same type specifier. Space the variable names with comma. There must be a space at least between the type specifier and variable name.
  2. The last variable name must be ended with ";".
4. The variable declaration must be in front of variable usage. It is always at the head of function body.

```
[Practice] //1int a,b;  
short int c;  
short d=100;  
a=d-20;  
b=a+d;  
c=a+b+d;  
d=d-a+c-b.
```

#### 5. Float constant

Real constant is also called float constant. Real constant is also called float constant. In the C language, the float is indicated with decimal only. It has two forms as following: Decimal form and exponential form

1.Decimal form

It is composed with figure 0-9 and decimal point. For example: 0.0,.25,5.789,0.13,5.0,300.,-267.8230 are the legal float number.

## 5. Exponential form

It is composed of decimal digit, exponent symbol "e" or "E" and exponent (be integer only, symbol is possible). The basic form is an E n (a is decimal, n is decimal integer) and the value is  $a \cdot 10^n$ . For example, 2.1E5 (equal to  $2.1 \cdot 10^5$ ), 3.7E-2 (equal to  $3.7 \cdot 10^{-2}$ ), 0.5E7 (equal to  $0.5 \cdot 10^7$ ), -2.8E-2 (equal to  $-2.8 \cdot 10^{-2}$ ). The following are the illegal float number: 345 (without decimal point) E7 (without figure before exponent symbol) -5 (without exponent symbol) 53.-E3 (negative sign is incorrect) 2.7E (without exponent)

The standard floating number in C language has suffix. The figure with suffix "f" or "F" is the floating number. For example, 356f and 356 is equivalent.

## 6. Float variable

The float variable includes single and double. Their type specifiers are float and double. In the Turbo C, the single occupies four bytes (32-bit) memory, and it is ranged between  $3.4E-38 \sim 3.4E+38$ , which provides seven effective figures only. The double occupies 8 bytes (64-bit) memory, and the value is ranged between  $1.7E-308 \sim 1.7E+308$ , which provides sixteen effective figures.

The form and written rules for float variable declaration is same with that of integer.

For example: `float x,y; (x,y is single float)`

`double a,b,c; (a,b,c is double float)`

The float constant is not classified into single and double. All float constants are processed as double.

```
a ■■■■
b ■■■■■■■■
a<---33333.33333
b<---33333.333333333;
[Practice]//floatint a=32;
float b;
Double d;
b=1234568;
d=b*100;
d=d+a;
d=d+58.123456;
```

## 7. Character

Characters include character constant and character variable.

Character constant

Character constant is a character within single quote. For example, 'a', 'b', '=', '+', , '?' are the legal character constants. In the C language, the character constants are always characterized as following:

1. Character constant must be included in single quote rather than double quotes or other brackets.
2. Character constant must be single character rather than character string.
3. Character may be any character in the character set. However, the figure cannot be involved in numerical operation after been defined as character. For example, '5' and 5 is different. '5' is character constant that are not involved in operation.

## 8. Character variable

The character variable value is character constant, i.e. single character. Its type specifier is char. The form and written rules of character variable declaration is same with that of integer variable.

For example:

char a,b;As each character variable is assigned to a byte memory, one character is saved only. The character value is kept in the memory unit with ASCII code. For example, the decimal ASCII code for x is 120, and the decimal ASCII code for y is 121. Give 'x' and 'y' to character variable a and b: a='x', b='y'. Actually, it is to store 120 and 121 BC in a and b unit:

```
a 0  1  1  1  1  0  0  0
b 0  1  1  1  1  0  0  1
```

Therefore, they can be regarded as integer. C language allows to give character value to integer variable and give integer to character variable as well. It can output character variable as integer and output integer as character. The integer is 2-byte, and character is single byte. When the integer is processed as character, the low eight bytes are involved only.

```
[Practice]//charint a=49;
char b;
char d;
b=a+10;
d=a+b;
[Practice] //char c1,c2;
c1='a';c2='b';
c1=c1-32;c2=c2-32;
```

## 9. Character string constant

Character string constant is a character string included in double quotes. For example: "CHINA". "C program", "\$12.5", they are legal character string constants. The character string constant is different from character constant. Their differences are described as following:

1. Character constant is included in single quotes while character string constant is included in double quotes.
2. Character constant is single character only while character string constant contains one or several characters.
3. A character can be given to a character variable, but a character string constant can not. In the C language, there is no corresponding character string variable.
4. The character constant occupies one byte in the memory. The bytes of character string constant are equal to the bytes of character string plus 1. Save character "\0" (ASCII code:0) in the increased byte. This is the ending symbol of character string. For example, the byte of "C program" in memory is C program\0. Although the character constant 'a' and character string constant "a" has one character both, their memory occupation is different.

'a' occupies one byte in the memory, which is indicated as a

"a" occupies two bytes in the memory, which is indicated as a\0 symbol constant.

## 10. Symbol constant

In the C language, a constant can be expressed with an identifier, which is called symbol constant. It must be defined before usage. Its general form is:

```
#define symbol constant
```

Wherein, #define is a preprocessor directive, which is called macro definition directive. It is used to define the identifier to the constant value. Upon definition, all of this identifier in the future program will be replaced by the constant value. Usually, the identifier of symbol constant is expressed with capital letter and the variable identifier is expressed with lowercase letter for distraction.

```
#define      PI
3.14159     void
main(){
```

```

float s,r;
r=5;
s=PI*r*r
;
printf("s=%f\n",s);

}

```

It is defined by macro definition directive. P1 is defined to be 3.14159, and s,r is defined to be float.

5->r PI\*r\*r->s

Display program result float s,r. wherein, r=5, s=PI\*r\*r. This program is defined by macro definition directive before main function. P1 is 3.14159, which substitutes for P1 in the program. s=PI\*r\*r is equivalent to s=3.14159\*r\*r. Pay attention: symbol constant is not variable. Its value can not be changed in the overall action scope. That is to say, assignment statement is forbidden to re-assign in the program.

## 7.1.2 Initial value of variable and type conversion

---

### 1. Initial value assignment for variable

In the program, it is usually to assign initial value for the variable. There are many methods for initial value assignment in the language program, which are called initialization. In the variable declaration, the general form of initial value assignment is:

Type specifier variable 1 = 1, variable 2 = 2, .....; for example:

```
int a=b=c=5;
```

```
float x=3.2,y=3f,z=0.75;
```

```
char ch1='K',ch2='P';
```

Note: no continuous assignment is forbidden in the declaration, for instance a=b=c=5 is illegal.

### 2. Type conversion of variable

The variable type is convertible. There are two methods for conversion. One is automatic conversion,



---

the other is forced conversion.

#### Automatic conversion

When the different types of data are involved in hybrid operation, the automatic conversion is completed by compilation system. The auto conversion should conform to the following rules:

1. If the data types involved in operation are different, first convert them into one type, then make operation.
2. Conversion is made as the data length so as to ensure the high precision. For example, when int and long is in operation, convert int into long, then make operation.
3. All float operations are double. Even the expression contains float only, it must be converted to double for operation.
4. Char and short must be converted into int for operation.
5. In the assignment operation, when the data types on both sides of assignment sign are different, the right data type will be converted to the left type. If the right data is longer than left one, it will loss a part of data. In this case, the precision will be reduces. The lost data will be rounded off.

### 3. Forced type conversion

The forced type conversion is achieved by type conversion operation. Its general form is (type specifier) (expression). It is used to convert the operation results into the specified type of type specifier by force. Take an example of (float) a. convert a to float (int)(x+y), convert the result of x+y into integer. In forced conversion, there are some points to be noted:

1. Type specifier and expression must be included in the bracket (the single variable may not be bracketed). If (int)(x+y) is written to be (int)x+y, it means to convert x into int and plus y.
2. Either forced conversion or auto conversion is just the temporary conversion of data length for convenience of the operation. It will not change the variable type in the data declaration.

---

### 7.1.3 One-dimensional array

---

In the program design, the array organizes several variables with same category in ordered form for convenience. The set containing data elements with the same category in order is called array. In C language, the array belongs to construction data. One array can be split into several array elements. These array elements are either basic data or construction data. Therefore, the array can be classified into numerical array, character array, pointer array, structure array according to the category of array element.

This section will introduce the numerical array and character array, others will be described in the successive sections. If the array type declaration uses array in C language, it must be made type declaration first. The general form of array declaration is: type specifier array name [constant expression]. Wherein, type specifier refers to any basic data or construction data. Array name refers to the array identifier defined by users. The constant expression in square bracket indicates the quantity of data elements, which is also called array length.

For example:

`int a[10];` int array a contains 10 elements.

`float b[10],c[20];` float array b contains 10 elements; float array c contains 20 elements.  
`char ch[20];` character array ch contains 20 elements.

For the array type declaration, there are several points as following:

1. The array type actually refers to the value type of array element. For the same array, the data type of all elements is the same.

2. The writing rules for array name should conform to that of identifier.

3. The array name should not be same with other variable name. For example: `void main ()`  
{

```
int a;
```

```
float a[10];
```

```
.....
```

```
} is incorrect
```

4. The constant expression in the square bracket refers to the element quantity. For example, a [5]

indicates that array a contains 5 elements. However, its subscript is started from 0. Therefore, the five elements are a[0],a[1],a[2],a[3],a[4].

5. The square bracket can not include the element quantity of variables but symbol constant or constant expression is available. For instance:

```
#define F
void main ()
{
int a[3+2],b[7+FD];
.....
```

} is legal. However, the following expression form is incorrect.

```
void main()
{
int n=5;
int a[n];
.....
}
```

6. It is allowed that the same type declaration can describe several arrays and several variables.

For example: `int a,b,c,d,k1[10],k2[20];`

### 1. Representation of array element

Array elements are the basic unit of array. It is also a variable, which is identified with array name and a subscript. The subscript indicates the sequence number of element in the array. The general form of array element is: array name [subscript]. Wherein, subscript is integer constant or integer expression only. If it has decimal, this value will be integer automatically by C programming. For example, a[5],a[i+j],a[i++] are the legal array elements. Array element is usually called subscript variable. The subscript variable could not be used unless array is defined. In C language, the subscript variable is used one by one rather than the whole array.

The general form of initialization assignment is: static type specifier array name [constant expression]=[value.....]. Wherein, static refers to the static storage type. It is specified that only static storage array and external storage array can be initialized assignment (the relevant static storage and external storage concepts will be introduced in Chapter 5) in C language. The data in { } are the initial value of each element, and the elements are spaced with comma such as static int

`a[10]={ 0,1,2,3,4,5,6,7,8,9 }`, which is equivalent to `a[0]=0;a[1]=1...a[9]=9;`

## 2. There are several provisions for initial assignment of array in C language:

1. It is allowed to assign initial value for partial elements. When the elements in { } is less than element quantity, the initial value is assigned for the front only. For example: `static int a[10]={0,1,2,3,4}`, it indicates that the initial value will be assigned for the first 5 elements `a[0] ~ a[4]`, and the last 5 elements will be assigned 0 automatically.

2. Assign initial value for element one by one, and the overall assignment for array is unavailable. For example, if assigning 1 for 10 elements, it can write to be `static int a[10]={1,1,1,1,1,1,1,1,1,1}` rather than `static int a[10]=1`.

3. If the initial value assignment is unavailable for all arrays with initialization, all elements will be 0.

3. If assigning all elements, the array element quantity may not be given in the array declaration. For example: `static int a[5]={1,2,3,4,5}` can be written as `static int a[]={1,2,3,4,5}`. The dynamic assignment can be made during program execution. In this case, it can use `do` statement and `scanf` function to assign the array elements one by one.

## 3. Character array

The array for storing characters is called character array. The form of type declaration for character array is same to that of numerical array as previous introduction. For example: `char c[10]`. As the character and integer is similar, it can be defined as `int c[10]`, but each array element occupies 2 bytes in memory. The character array may be two-dimensional array. For instance, `char c[5][10]` is a two-dimensional character array. The character array is allowed to made initialization assignment in type declaration. Take `static char c[10]={'c',' ','p','r','o','g','r','a','m'}` as an example. After assignment, the element value is `c[0]c[1]c[2]c[3]c[4]c [5]c[6]c[7]c[8]c[9]` for array C. Wherein, `c[9]` is not assigned and assigned to 0 by system automatically. When assigning initial value for all elements, the length declaration can be omitted such as `static char c[]={'c',' ','p','r','o','g','r','a','m'}`, in which the length of C array is set to 9.

C language allows for initialization assignment for array in character string. For example, `static char c[]={'c',' ','p','r','o','g','r','a','m'}` can be written to `static char c[]="C program"` or `static char c[]="C program"` without { }. The assignment in character string occupies one more byte than assignment one by one. It is used to store the ending sign of character string '\0'. The actual storage of array

c in memory is C program\0. Wherein, '\0' is added by C programming system automatically. As '\0' sign is adopted, the array length is not normally defined in initialization assignment of character string but processed by system automatically. If in the mode of character string, the input and output of character array becomes simple and convenient. Except the initial value assignment with character string, it can input and output the character string of one character array with printf function and scanf function at one time not requiring input/output each character with do statement one by one.

## 7.1.4 Basic operator and expression

---

### Category, priority and associativity of operator

There are many operators and expressions in C language, which is seldom in the high-level language. It is the rich operator and expression that complete the C language. This is one of main features of C language.

The operators of C language have different priorities. In addition, they have individual associativity. In the expression, the data for operation should not only conform to the priority of operators but also subjected to the associativity so as to confirm the operation direction from left to right or from right to left. This associativity is unavailable for other high-level language, which increases the complexity of C language.

#### Operator Category

The operators of C language can be classified as following:

#### 1. Arithmetic operator

It is used for different data operations, including addition (+), subtraction (-), multiplication (\*) and division(/) (or modular arithmetic, %), increment (++) and decrement (--).

#### 2. Relational operator

It is used for comparison operation, including greater than (>), less than (<), equal to (==), be equal or greater than (>=), be equal or less than (<=) and unequal to (!=).

#### 3. Logical operator

It is used for logical operation, including And (&&), Or (||) and Not (!).

#### 4. Bit operation operator

The data for operation is taken as binary bit, including bit and (&), bit or (|), bit not (~), bit or (^), left shift (<<) and right shift (>>).

#### 5. Assignment operator

It is used for assignment operation, including simple assignment (=), composite arithmetic assignment

(+=, -=, \*=, /=, %=)

and composite bit operation assignment (&=, |=, ^=, >>=, <<=).

## 6. Conditional operator

This is a ternary operator for conditional evaluation (?:).

## 7. Comma operator

It is used for combining several expressions to one expression (, ).

## 8. Pointer operator

It is used for two operations as content-of (\*) and address-of (&).

## 9. Size-of operator

It is used for size-of operation of data.

# 7.1.5 Section summary

---

## 1. C data type

Basic type, construction type, pointer type and void type

## 2. Classification and characteristics of basic type

| Type Specifier | Byte | Number Range                             |
|----------------|------|--|
| char           | 1    | C character set                          |
| int            | 4    | -214783648 ~ 214783647                   |
| short int      | 4    | -214783648 ~ 214783647                   |
| long int       | 8    | -922337203685477808 ~ 922337203685477807 |
| unsigned       | 4    | 0 ~ 4294967295                           |
| unsigned long  | 8    | 0 ~ 1844744073709551615                  |
| float          | 4    | 3/4E-38 ~ 3/4E+38                        |
| double         | 8    | 1/7E-308 ~ 1/7E+308                      |

## 3. Constant suffix

---

L or l for long int

U or u for unsigned

F or f for float

#### **4. Constant type**

Int, long int, unsigned, float, char, char string, symbol constant, and escape character

#### **5. Data type conversion**

Auto conversion

The system realizes auto conversion for the hybrid operation of different types of data, which converts from small byte data to big byte data. For the mutual assignment of different data, the system also converts automatically, which converts the right data type into left one.

Forced conversion

It is converted by forced conversion operator.

#### **6. Priority and associativity of operator**

Generally speaking, the unary operator has higher priority and the assignment operator has lower priority. The arithmetic operator has higher priority, and the relational and logical has lower priority. Most operators have left associativity, unary operator, ternary operator and assignment.

#### **7. Expression**

Expression is the formula composed with connection constant, variable and function of operator. Each expression has one value and type. The evaluation of expression is made according to the sequence specified by priority and associativity of operator.

#### **8. Array**

1. Array is the commonest data structure in program design. The array contains numerical array (int array, float array), character array and pointer array, structure array to be described later.
2. Array may be one-dimensional, two-dimensional or multi-dimensional.
3. The type declaration of array consists of type specifier, array name and array length (elements quantity of array). The array element is also called subscript variable. The array type refers to the value type of subscript variable.
4. Make array assignment with three methods: initialization assignment, dynamic assignment by inputting function and assignment statement. The numerical array can not be overall assigned, input or output with assignment statement but assigned for array element one by one with do statement.

---

## 7.2 C language programming preliminary

---

- [Statement of C program](#)
- [Branch structure program](#)
- [switch statement](#)
- [Loop structure program](#)
- [for statement](#)
- [break statement](#)
- [continue statement](#)
- [Section summary](#)

### 7.2.1 Statement of C program

---

The execution part of C program is constituted by statements, and the program function is also realized by execution statement. C statement is classified into five categories:

1. Expression statement
2. Control statement
3. Compound statement
4. Null statement



## 1. Expression statement

Expression statement consists of expression and semicolon. Its general form is `expression;`. Execution of expression statement is to compute the expression value. For example, `x=y+z;` assignment statement `y+z;` operate statement with addition, but the result is not kept. It has no actual significance `i++`. Increment 1 statement, `i` value increases 1.

## 2. Control statement

Control statement is to control the program process so as to realize various structures of program.

It is composed of special statement delimiter. There are nine control statements in C language, which can be classified into three kinds:

### (1) Conditional judgment statement

`if` statement, `switch` statement

### (2) Looping execution statement

`do while` statement, `while` statement, `for` statement

### (3) Go to statement

`break` statement, `goto` statement, `continue` statement, `return` statement

## 3. Null statement

The statement with semicolon only is called null statement. Null statement executes nothing. In the program, null statement can be the null loop body. Take an example of `while (getchar()!='\n')`. For this statement, if the character input from keyboard is not Enter, it requires re-input. Here, the loop body is null statement.

## 4. Assignment statement

Assignment statement consists of assignment expression and semicolon. Its general form is `variable = expression;`. Its functions and features are same to that of assignment expression. It is one of the most popular statements in the program. There are some points to be noted in the usage of assignment statement:

1. As the expression on the right of assignment sign "=" can be an assignment expression,

---

the following form `Variable=(variable=expression);` is established, then the nestification is formed. Its expanded expression is `Variable=Variable=...=Expression;`

For  
example:

`a=b=c=d=e=5;` according to the right associativity of assignment operator, it is equivalent to: `e=5` actually;

```
d=e;  
c=d;  
b=c;  
a=b  
;
```

2. Pay attention to the difference between assigning initial value and statement for variable in the variable declaration. Assigning initial value to variable is a part of variable declaration. The variable with initial value assignment should be spaced with comma to other similar variable, but the assignment statement must be ended with semicolon.

3. In the variable declaration, it is forbidden to assign initial value for several variables successively. For example, the following declaration is incorrect. `int a=b=c=5` must be written to `int a=5,b=5,c=5`. However, the assignment statement must be assigned continuously.

4. Note the difference between assignment expression and assignment statement. Assignment expression is a kind of expression, which can be used in any allowable place. But the assignment statement can not. The following statement is legal: `if((x=y+5)>0) z=x;` the function of statement: if expression `x=y+5` is greater than 0, then `z=0`.

The following statement is illegal: `if((x=y+5;)>0) z=x;` as `x=y+5;` is a statement, it can not be used in expression.

## 7.2.2 Branch structure program

---

### Relational operator and expression

In the program, it usually compares the size of two data so as to confirm the next process. The operator for comparing data size is called the relational operator. There are such relational operators in C

language as following:

< less than

<= less than or equal to

> greater than

>= greater than or equal to

== equal to

!= unequal to

The relational operator is binary operator, which is left associative. Its priority is lower than that of arithmetic operator and higher than that of assignment operator. In the six relational operators, <,<=,>,>= has the same priority, which is higher than == and !=. While == and != has the same priority.

### Relational expression

The general form of relational expression is Expression Relational operator Expression. For example,  $a+b>c-d$ ,  $x>3/2$ ,  $'a'+1<c$ ,  $-i-5*j==k+1$  are legal relational expression. As the expression is relational expression concurrently, the nestification may occur such as  $a>(b>c)$ ,  $a!=(c==d)$  etc. The value of relational expression is "true" and "false", which is expressed with "1" and "0".

### 1. Logical operator and expression

In C language, the logical operators include AND operator &&, OR operator || and NOT operator !. AND operator && and OR operator || are binary operators with left associativity. NOT operator ! is unary operator with right associativity. The priority relation between logical operator and other operators can be expressed as following:

The following can be derived depending on the priority of operator:

$a>b \ \&\& \ c>d$  is equivalent to  $(a>b) \ \&\& \ (c>d)$

$!b==c \ | \ d<a$  is equivalent to  $((!b)==c) \ | \ (d<a)$

$a+b>c \ \&\& \ x+y<b$  is equivalent to  $((a+b)>c) \ \&\& \ ((x+y)<b)$

Evaluation of logical operation

The evaluation of logical operation may be true or false expressed with 1 and 0 individually. Its evaluation rules are as following:

1. When the two values of AND operation && are true, the results are true; otherwise they are false. For example,  $5>0 \ \&\& \ 4>2$ . As  $5>0$  is true and  $4>2$  is true, the corresponding result is true.

2. When one of two values involved in OR operation || is true, the result is true. When two values are false,

the result is false. Take an example of  $5 > 0 \mid \mid 5 > 8$ . As  $5 > 0$  is true, the corresponding result is true.

3. When the NOT operation! involved in operation is true, the result is false; when the involved operation is false, the result is true.

For example, the result of  $!(5 > 0)$  is false.

In the logical operation value of C programming, it represents "true" with "1" and represents "false" with "0". Vice versa, when judging a value is true or false, 0 represents false and the non-zero data represents true. For example, as 5 and 3 are non zero, the value of  $5 \&\&3$  is "true" (i.e. 1).

Another example: the value of  $5 \mid \mid 0$  is "true" (i.e. 1).

The general form of logical expression is Expression – Logical operator – Expression. Wherein, the expression can be logical expression as well, which forms nestification? Take the  $(a \&\&b) \&\&c$  as an instance. The above expression can be written to  $a \&\&b \&\&c$  according to the left associativity of logical operator. The value of logical expression is the final value of various logical operation, which represents "true" and "false" with "1" and "0" respectively.

## 2. if statement

The branch structure can be constituted with if statement. It makes judgment according to the given conditions so as to confirm what branch program period is to be executed. If statement of C language has three basic forms.

1. The first form is: basic form. `if (expression) statement`

It's semanteme: if the expression value is true, the following statement will be executed, otherwise not.

2. The second form is if-else. `if(expression)  
statement 1; else statement 2;`

Semanteme: if the expression value is true, it will execute statement 1; otherwise statement 2.

Input two integers, and output the bigger one. Judge a and b size with if-else statement. If a is bigger, it outputs a;

otherwise b.

## 3. The third form is if-else-if form.

In the first two forms, if statement is normally used for two branches. When there are several branches for selection, if-else-if statement is adopted. Its basic form is:

`if(expression 1)`

`statement 1;`

`else if(expression 2)`

`statement 2;`

`else if(expression 3)`

---

```
statement 3;
```

```
...
```

```
else if(expression m)
```

```
statement m; else statement n;
```

Semanteme: judge the expression value in sequence. When a value is true, it executes the corresponding statement. Then it executes program out of if statement. If all expressions are false, it will execute statement n. Then continue to execute the subsequent program.

**There are some points to be noted in if statement:**

- (1) In the three forms of if statement, the one behind if is expression. This expression is usually the logical expression or relational expression. But it may be other expressions such as assignment expression even a variable. For example, `if(a=5)` statement and `if(b)` statement are allowable. As long as the expression value is not 0, it is true. If the expression value in `if(a=5)...`; expression is always not 0, the subsequent statement will be executed. This kind of situation may not take place in the program, but the syntax is legal.

Another example, program segment: `if(a=b)`

```
printf("%d",a)
```

```
; else
```

```
printf("a=0");
```

Semanteme of the statement: assign b to a. if it is not 0, this value is output; otherwise it outputs "a=0" character string. This kind of application usually occurs in the program.

- (2) In if statement, the conditional judgment expression must be included in bracket, and ended with semicolon.
- (3) In the three forms of if statement, all statements should be single statement. If a group (several) statements are required execution with conditions, this group of statements must be bracketed with `{}` to form a compound statement. Pay attention that no semicolon is allowed behind `}`.

For example:

```
if(a>b){
```

```
    a++;
```

```
    b++;
```

```

}

else{ a=0;

b=10;

}

```

#### 4. Conditional operator and conditional expression

If the single assignment statement is executed only in the conditional statement, it is usually realized by conditional expression, which not only simplifies the process but also improves the operation efficiency.

Conditional operator ? and : is a ternary operator, which means three values are involved in operation. The general form of conditional expression composed by conditional operators is:

Expression 1 ? Expression 2: Expression 3

Its evaluation rule: if the expression 1 is true, its value of expression 2 will be the value of conditional expression; otherwise, the value of expression 2 will be the value of whole conditional expression. Conditional expression is normally applied in assignment statement. For example:

```

if(a>b) max=a;

else max=b;

```

max=(a>b)?a:b; is expressed with conditional expression. Its semanteme is: if a>b is true, assign a to max; otherwise assign b to max.

In the application of conditional expression, there are some points to be noted as following:

1. The operation priority of conditional operator is lower than that of relational operator and arithmetic operator but higher than assignment operator. Therefore, max=(a>b)?a:b can be removed the bracket to be max=a>b?a:b.
2. Conditional operator ? and : is a pair of operator, which can not be separated in application.
3. The associative direction of conditional operator is from right to left.

### 7.2.3 switch statement

---

C language provides another switch statement for selection of multiple branches. Its general form is:

```

switch(expression){
case constant expression 1: statement 1;

case constant expression 2: statement 2;

```

...

```
case constant expression n: statement n;
```

```
default: statement n+1;
```

```
}
```

Semanteme: calculate the expression value, and compare with the subsequent constant expression value one by one. When the expression value is equal to a constant expression value, the subsequent statement is executed. Then judgment is not made. Continue the statement behind all case. If the expression value is different from the constant expression behind case, it will execute the statement behind default.

There are several points to be noted in switch statement:

1. All constant expression values behind case must be different, otherwise there will be mistake.
2. Several statements are allowed behind case, and they can not be bracketed with {}.
3. The sequence of case and default clauses may be changed and will not affect the program execution.
4. Default clause may be omitted

## 7.2.4 Loop structure program



The loop structure is an important structure of program. When the given condition is satisfied, one program segment is executed repeatedly until the condition is unsatisfied. The given condition is called loop condition, and the program segment executed repeatedly is called loop body. C language provides many loop statements, which may compose different loop structures.

### 1. While statement

The general form of while

```
statement: While (expression)
```

statement;

wherein, the expression is loop condition, and the statement is loop body.

Semanteme of while statement: compute the expression value. When the value is true (not 0), the loop body statement is executed.

There are some points to be noted in while statement:

1. The expression of while statement is usually the relational expression or logical expression. As long as the expression value is true (not 0), it can continue loop.
2. If the loop body contains one or more statements, it must be bracketed with {} to form the compound statement.
3. Note the loop conditions to avoid endless loop.

## 2. Do-while statement

General form of do-while statement:

```
do  
statement;
```

```
while  
(expression);
```

Wherein, the statement is loop body, and the expression is the

loop condition. Semanteme of do-while statement:

First execute the loop body statement for one time, then judge the expression value. If the value is true (not 0), the loop is continuous; otherwise the loop ends.

The difference between do-while statement and while statement is that do-while executes first and judges late. Therefore, do-while will execute the loop body for one time at least. But while statement judges first and executes late. If the condition is unsatisfied, the loop body statement is not executed for one time.

while statement and do-while statement is usually mutual re-write.

In this example, the loop condition is rewritten to be  $-n$ . Otherwise, one more loop

will be executed. There are some points to be noted in do-while statement:

1. In the if statement and while statement, no semicolon is added behind the expression; while the expression of do-while statement must be ended with semicolon.
2. do-while statement may be composed to the nested loop and nested with while statement mutually.



3. The loop body between do and while is made up of several statements, and bracketed with {} to form a compound statement.
5. When converting do-while and while statement mutually, pay attention to modify the loop control conditions.

## 7.2.5 for statement



---

For statement is a kind of loop statement with stronger function and wider application provided by C language. Its general form is:

```
For (Expression 1;Expression 2;Expression 3)
```

```
statement;
```

Expression1: it is usually to assign initial value to loop variable, and it is assignment expression. It also allows to assign initial value to loop variable except for statement. In this case, the expression may be omitted.

Expression 2: it is usually the loop condition, and it is relational expression or

logical expression. Expression 3: it is usually for modifying the value of loop variable, and it is assignment statement.

These three expressions may be comma expression. That is to say, each expression can be composed with several expressions. Three expressions are options and can be omitted.

The "statement" in general form is loop body statement. Semanteme of for statement is:

1. First, calculate the value of expression 1.
2. Then, compute the value of expression 2. If the value is true (not 0), loop body is executed once more; otherwise exit the loop.
3. Calculate the value of expression 3 and return to execute step 2 again. During the for process, expression 1 is calculated for one time, and expression 2 and 3 may repeat for several times. The loop body may be executed for many times or not executed.

There are several points to be noted in for statement:

1. Each expression in for statement can be omitted, but the semicolon must exist.

For example:

<1>for(expression; expression) expression is omitted

<2>for(expression; expression;)expression is omitted

<3>for(;expression; expression) all expression is omitted

2. When the loop variable has assigned initial value, Expression 1 may be omitted as shown in Example 3.27. If Expression 2 or 3 is omitted, the endless loop may be caused. In this case, the loop should be ended in loop body.

3. The loop body may be void statement.

```
#include"
stdio.h" void
main(){
int n=0;
printf("input a
string:\n");
for(;getchar()!='\n';n+
+); printf("%d",n);
}
```

In this example, the expression 1 in for statement is omitted, and the expression 3 is not for modifying loop variable but for inputting the characters counting. Thus, the counting that should be completed in loop body has completed in the expression. Therefore, the loop body is void statement. Pay attention, the semicolon behind void statement is essential. If this semicolon is missed, the following printf statement will be executed as loop body. On the other hand, if the loop body is not void statement, it is forbidden to add semicolon behind the bracket of expression. In this case, the loop body will be regarded as void statement and not executed repeatedly. All of these are the common mistakes in programming, which must be attached great importance.

## 7.2.6 break statement



---

Break statement is used in switch statement or loop statement only. It is for exiting switch statement or local loop and directing to the subsequent program. As the transferring direction of break statement is specific, the statement marks are not required. The general form of break statement is break. As shown in the above example, the break statement is used in switch statement and for statement for skip. Break statement provides several exits for loop statement, which makes programming more flexible and convenient in some circumstances.

## 7.2.7 continue statement



---

Continue statement is used in loop

body only. Its general form is continue;

Semanteme: finish this loop and not execute the other statement behind continue statement in the loop body any more, turn to judge and execute the next loop condition. Pay attention: this statement only ends the loop on this layer and will not exit the loop.

## 7.2.8 Section summary



---

1. From the execution process, the program is basically classified into three basic structures: sequence structure, branch structure and loop structure.

2. The most basic unit in program execution is statement. There are five kinds of statements in C language:

(1) Expression statement any expression and semicolon forms the expression statement. The general expression statement is assignment statement.

(2) Function call statement the function call and semicolon constitutes the function call statement.

(3) Control statement it is used for control program process, and composed of special statement

---

delimiter and required expression. It mainly includes conditional judgment execution statement, loop execution statement, go to statement etc.

(4) Compound statement it is composed by several statements included in {}. Compound statement is regarded as single statement. It can be used in any place allowing statement such as loop body.

(5) Void statement it is composed by semicolon only without actual function.

3. Relational expression and logical expression are two important expressions, which are mainly used for judgment of conditional execution and loop execution.

4. C language provides many forms of conditional statement to form the branch structure.

(1) if statement is mainly for one-way selection.

(2) if-else statement is mainly for two-way selection.

(3) if-else-if statement and switch statement are for multiway selection.

These forms of conditional statement are normally mutual substituted.

5. C language provides three loop statements.

(1) For statement is mainly used to assign initial value for loop variable, step increment and loop structure of loop times.

(2) The loop times and control condition can be confirmed during loop process, and the confirmed loop may use while or do-while statement.

(3) Three loop statements can be nested mutually to form the nested loop. The loops may be in parallel but not crossed.

(4) Branch statement can transfer the process out of loop body, but it can not transfer process from outside to loop body.

---

( 5 ) Avoid endless loop in the loop program. That is to say, the loop variable must be ensured to be modified during operation. Change the loop condition to be false gradually, thus finish the loop.

#### 6. Statement summary in C language

| Name                  | General Form   |
|-----------------------|--|
| Simple                | statement  |
|                       | Expressi   |
|                       | on statement; Void statement;  |
| Conditional statement | if(expression)statement;   |
|                       | if(expression)statement 1; else statement 2;                                       |
|                       | if(expression 1)statement 1; else if(expression 2)                                 |
|                       | statement 2...else statement n; switch statement switch(expression){ case constant |
|                       | statement: statement...default: statement; } loop statement while statement        |
|                       | while(expression)statement;  |
|                       | for statement for(expression 1; expression 2; expression 3)                        |
|                       | statement; break statement break;  |
|                       | continue statement continue;   |
|                       | return statement return(expression);   |

### 7.3 Script function introduction

---

- [How to start the macro function for programming](#)

- 
- [Function introduction of each function button of macro command editor](#)
  - [How to create a new macro](#)
  - [Macro Encryption/Decryption](#)
  - [How to insert library functions in a program](#)
  - [How to use internal memory in macros](#)

### 7.3.1 Use script function to program

#### Use script function to program



This section will introduce the basic functions of script and describe the relevant control functions and application method briefly.

There are ways to access script :

Method 1: select "Setting (S) -> Macro" from the menu as shown in Figure 5-1 (script menu), and pop up interface as shown in Figure 5-1(script editor).



Figure 5-1 (Script Menu)

Method 2: click shortcut button “script ” as shown in Figure 5-2 (script button), and pop up interface as shown in Figure 5-3 (Script Editor).

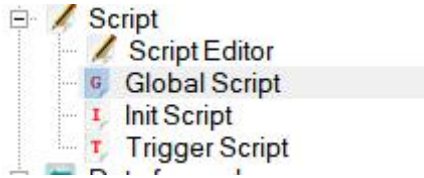

Figure 5-2 (Script Button)

### 7.3.2 Function button introduction in script editor



The functional controls are arranged in script editor window as shown in Figure 5-3 (Script Editor).

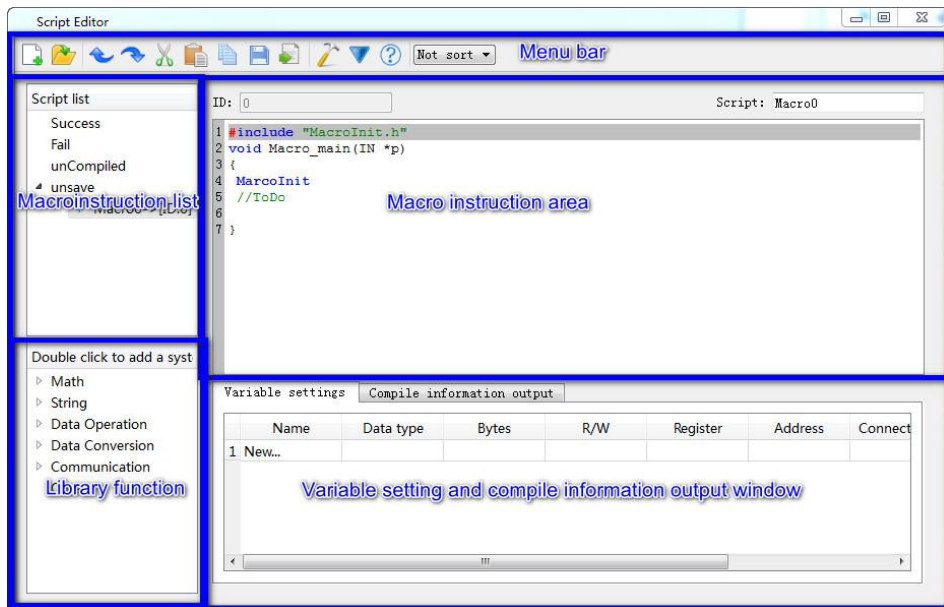

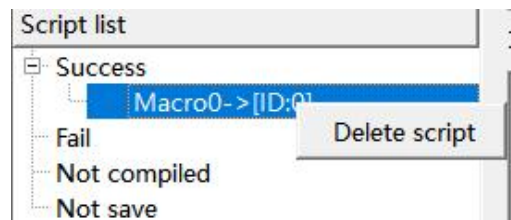

Figure 5-3 (Script Editor)

#### <1> Script List:

1.  **New:** new create a script

2.  **Import:** import an existence script.
3. **Success:** the scripts have been successful completed
4. **Fail:** the scripts have been failed completed
5. **Not completed:** the scripts have not been completed
6. **Not save:** the scripts have been saved
7. **Delete:** 'left click' chooses the script, then 'right click' pop out 'Deletes script', click the delete



<2> **Script Edit window:** Edit and compile script on this window. "ID":The number of the current edit script, "Script":Modify the name of the current edit script.



: Script Edit Menu: there are ten

button totally, as follows:



**Undo:** cancel the last operation.



**Redo:** redo the next operation.



**Cut:** cut the choosed script.



**Paste:** paste script.





**copy:** copy script.



**Save:** save script.



**Export:** Pop the file save dialog, modify the root and name, save the script as a \*.csv file.



**Compile:** Compile the current script source code, and check the syntax error.



**Pack/Show the setting and output window.**



**Help:** Show the help file.



:Setting the macro instructions automatically sort by id

<3>**Setting and output window** : the window sets variable and outputs compiled information.

**“Variable Setting” Page:**click the “new”grid in this page, it will pop out the “New script variables” dialog, as shown in figure5.6.The variable associated with the register.

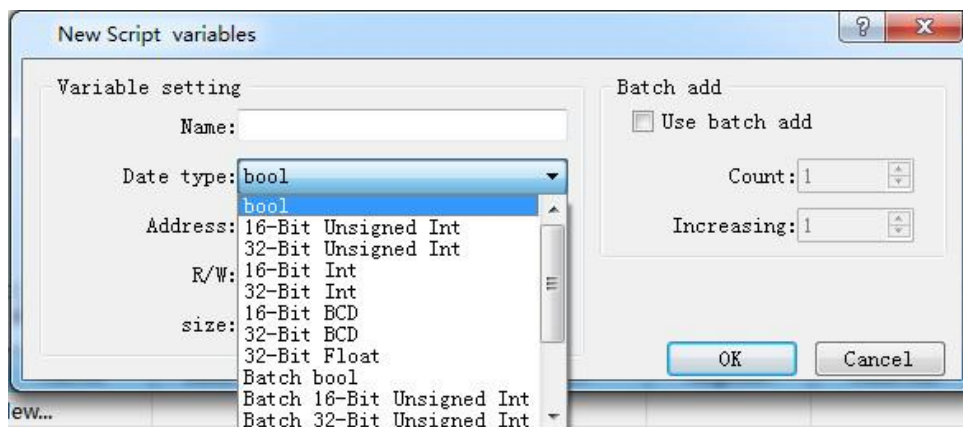

---

Figure5-5 New script variables

**“Compile information output”Page:**The window outputs the information of compilation and connection state of program. Users may make debugging and modification according to the information prompt.

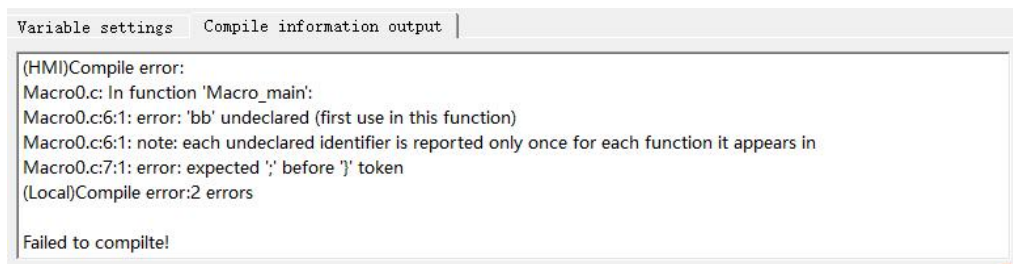

Figure5-6 Compile information output

**<4>Function List :** User can choose the system function,and insert it on the script edit window.

### 7.3.3 Macro Encryption/Decryption



The configuration software provides macro instruction encryption/decryption function, which enables users to protect their own private special functions. Even if others have configuration programs, they still cannot view the contents of macro instruction functions without the macro instruction password.

This chapter introduces the steps to use this function.

Keywords:[macro instruction encryption steps](#),[macro instruction function decryption steps](#), [macro instruction function password modification steps](#),[precautions](#)

## Macro instruction function encryption steps

Select the macro to be encrypted, right-click to select the "Encrypt" function, and set the password according to the prompts

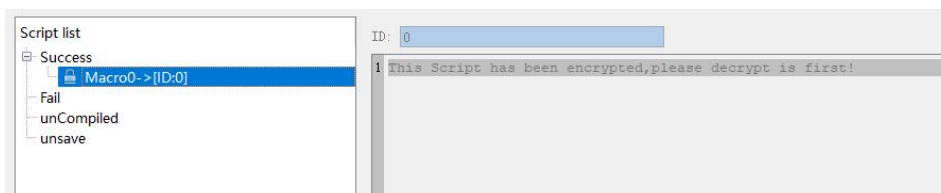
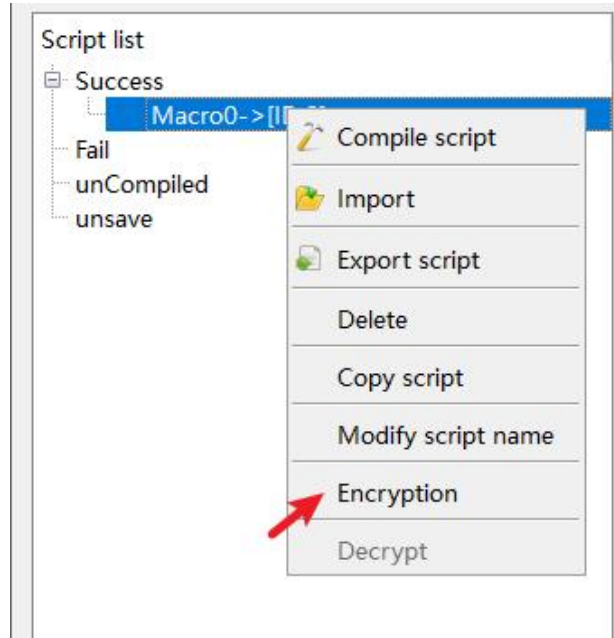

## Macro instruction function decryption steps

Select the macro to be decrypted, right-click to select the "Decrypt" function, and enter the password set during the encryption process according to the prompts

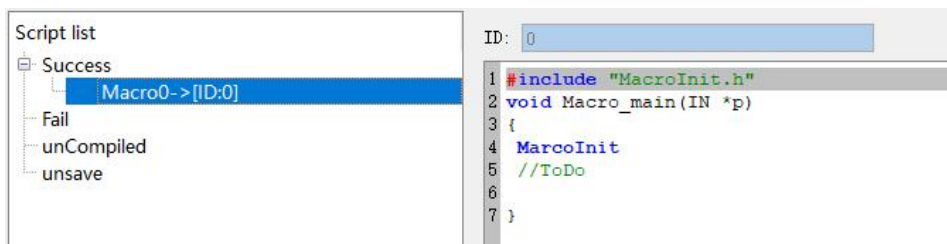
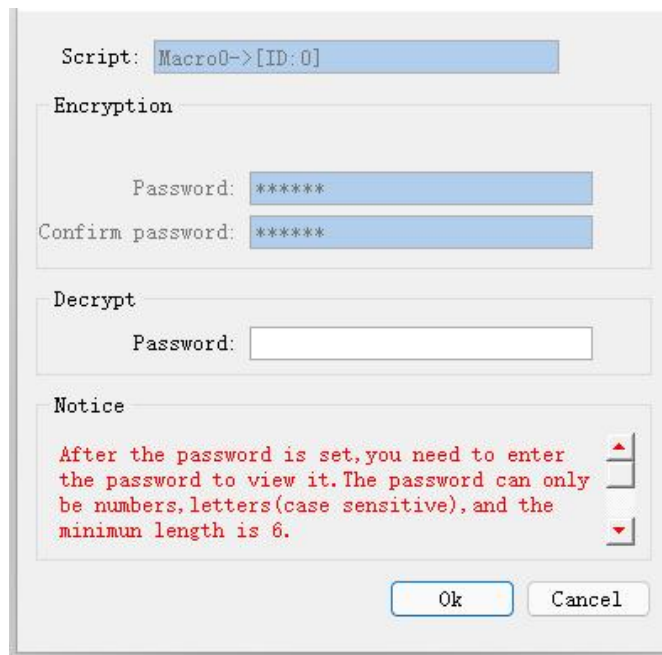
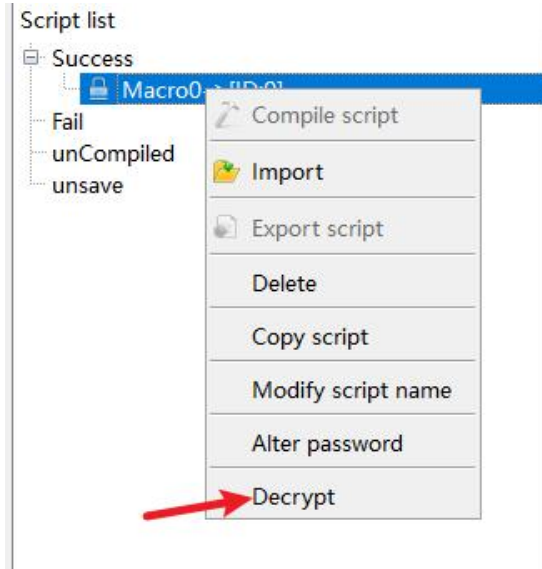

---

## Steps for modifying password in macro function

Select the macro command that needs to change the password, right-click to select the "change password" function, enter the old password according to the prompt, and set the new password

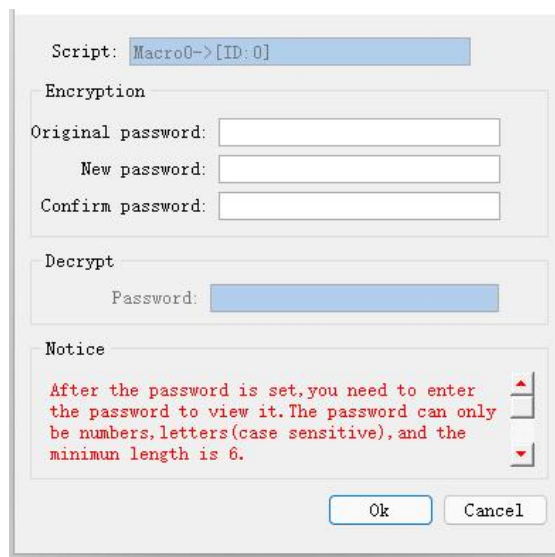
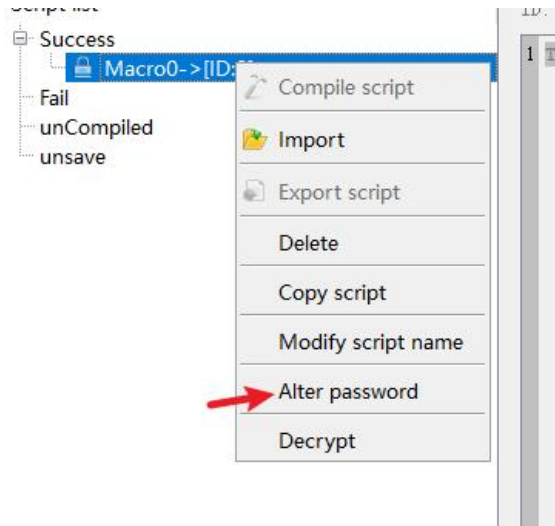

## Precautions

When the encrypted macro function is exported, the corresponding password will not be exported.  
When the macro is imported to other projects, it needs to be encrypted again.

## 7.3.4 New create script



Click  button and create a new script on the “Not save” list as shown in Figure 5-4 (Script Compiler)

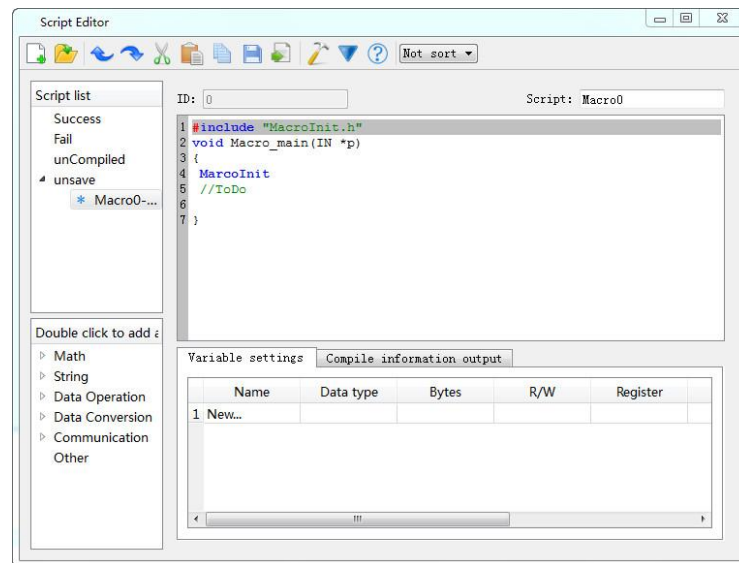

Figure 5-4 (Script Compiler)

### Instructions:

#### Instruction 1: convention introduction of program compilation

Create the source program of C language conforming to ANSI C standard in the edition window.

#### Instruction 2: information output window

The window outputs the information of compilation and connection state of program. Users may make debugging and modification according to the information prompt.

#### Instruction 3: variable setting

Variable name: input the variable name required in the program.

---

Data type: select the corresponding data class of variable name so as to distribute the corresponding memory size.

Bytes: set the occupied memory of corresponding variable automatically depending on the data class.

Read/write: set the read-write property of variable in the memory cell of touch screen.

Address: the defined physical memory address of variable in the touch screen.

Variable setting instruction: when the external requires interaction with touch screen such as data exchange and data acquisition, it provides the interface to change the behavior characteristics of touch screen dynamically.

Special tips: the variables required in the program should be put in the variable definition part (the variable definition starts from code).

### 7.3.5 Use internal storage area in script

#### Use internal storage area in Script



SKTOOL configuration software provides the operation interface for HMI internal storage area. Users can make direct operations for the internal storage area in the script. Detailed methods have two kinds:

1. Access storage area with keywords

LocalBit: reference of internal storage area LB; LocalWord: reference of internal storage area

---

LW; RWIWord: reference of internal storage area RWI.The keyword can be used directly in macro. For example:

```
if(LocalBit[5])
{
Local
Word
d[1]=
0;
}
else
{
Local
Word
d[1]=
1;
}
```

2. Establish a linkage between variable and internal storage area by setting of variable.

Detailed usage refers to script instance.

## 7.4 String handling functions



| Function name              | function   |
|----------------------------|--|
| <b>StringCat</b>           | Joint two character strings  |
| <b>StringCompare</b>       | Compare the values of two character strings; case sensitive            |
| <b>StringCompareNoCase</b> | Compare the values of two character strings; case insensitive          |
| <b>StringCopy</b>          | String copy  |
| <b>StringFind</b>          | Return to the position of the first occurrence of target string in the |



|                        |  |
|------------------------|--|
|                        | source string; if there is no found in the source string, return to -1.  |
| <b>StringFindOneOf</b> | Return to the position of the first character in the source string that matches any character in target string; if there is no found in the source string, return to -1. |
| <b>StringIncluding</b> | Retrieve a substring of the source string that contains characters in the set string.  |
| <b>StringInsert</b>    | Insert a string into a specific position within the destination string content.  |
| <b>StringLength</b>    | Obtain the length of a string.   |
| <b>StringMid</b>       | Retrieve some characters sequence from the specified offset of the source string.  |
| <b>StringSplit</b>     | Split out the string.  |
| <b>StringToLower</b>   | Convert the characters of a string to lowercase.   |
| <b>StringToUpper</b>   | Convert the characters of a string to uppercase.   |
| <b>StringTrim</b>      | Split the source2 out from source1 to form a new one with the rest.  |
| <b>StringTrimLeft</b>  | Split out any character of source2 in source1; Return the result to the dest.  |

## 1、StringCat

### [Description]

Append source string to destination string.

### [Usage]

```
result=StringCat(dest[start],source);
```

### [Example]

```
char a[8]="abcd";
char *b="efg";
char *c;
```

```
c=StringCat(a,b); // c="abcdefg" , it is better if a is a character array.
```

---

## 2、StringCompare

### [Description]

Do a case-sensitive comparison of two strings.

### [Usage]

```
result = StringCompare(source1,source2);
```

### [Example]

```
int result;
```

```
char *a="abcd";
```

```
char *b="efg";
```

```
result = StringCompare(a,b); //result=-1(if a>b, result=1;if a=b, result=0; if a<b then result=-1)。
```

## 3、StringCompareNoCase //

### [Description]

Do a case-insensitive comparison of two strings.

### [Usage]

```
result = StringCompareNoCase(source1,source2)
```

### [Example]

```
int result;
```

```
char *a="abcd";
```

```
char *b="EFG";
```

```
result=StringCompare(a,b);//result=1;
```

```
result=StringCompareNoCase(a,b);//result=-1;
```

## 4、StringCopy

### [Description]

Copy one string to another.

### [Usage]

```
result = StringCopy(dest,source);
```

### [Example]

```
char a[4]="abcd";
```

```
char* b="efg";
```

```
char* c;
```

```
c=StringCopy(a,b);//c="abcdefg"; it is better if a is a character array.
```

## 5、StringFind

### [Description]

Return the position of the first occurrence of target string in the source string.

### [Usage]

```
index=StringFind(source1,source2);
```

### [Example]

```
char a[8]="ab1c123d";
```

```
char* b="123";
```

---

```
char* c="ef";
int index;
index=StringFind(a,b); //index=4;
index=StringFind(a,c); //index=-1;
```

## 6、StringFindOneOf

### [Description]

Return the position of the first character in the source string that matches any character in target string.

### [Usage]

```
index=StringFindOneOf(source1,source2);
```

### [Example]

```
char a[8]="ab1c123d";
char* b="1b";
int index;
index=StringFindOneOf(a,b); //index=2;
```

## 7、StringIncluding

### [Description]

Retrieve a substring of the source string that contains characters in the set string.

### [Usage]

```
StringIncluding(source1,source2,dest);
```

### [Example]

```
char a[8]="aB1Eree";
char* b="aBe";
char dest[8];
StringIncluding(a,b,dest); //dest="aBee"; it is better if dest is a character array.
```

## 8、StringInsert

### [Description]

Insert a string in a specific within the destination string content. Notice it that the destination string has sufficient buffer.

### [Usage]

```
StringInsert(pos,source,dest);
```

### [Example]

```
char a[8] = "aB1e";
char *b ="kdr";
int pos=2;
StringInsert(pos,b,a); //a="aBkdr1e".
```

## 9、StringLength

### [Description]

Obtain the length of a string.

### [Usage]

---

```
result = StringLength(source);
```

**[Example]**

```
char a[8]="ABerer";  
int length;  
length = StringLength(a); //length=6;
```

## 10、StringMid

**[Description]**

Retrieve some characters sequence from the specified offset of the source string and store it in the destination buffer.

**[Usage]**

```
StringMid(source,count,dest);
```

**[Example]**

```
char a[8]="aB1e";  
char b[3];  
StringMid(a,2,b); //b="B1" it is better if b is a character array and it has enough memory to  
save the fetched character.
```

## 11、StringSplit

**[Description]**

Split out the string.

**[Usage]**

```
StringSplit(dest1,dest2,source,pos);
```

**[Example]**

```
char a[8]="aB1edge";  
char b[5];  
char c[5];  
StringSplit(b,c,a,3); // it is better if b and c are character arrays.
```

## 12、StringToLower

**[Description]**

Convert the characters of a string to lowercase.

**[Usage]**

```
StringToLower(source,dest); // it is better if dest is a character array.
```

**[Example]**

```
char a[8]="ABeRe";  
char b[8];  
StringToLower(a,b);//b="abere".
```

## 13、StringToUpper

**[Description]**

Convert the characters of a string to uppercase. Notice if there is sufficient buffer.

**[Usage]**

```
StringToUpper(source,dest);
```

---

**[Example]**

```
char a[8]="ab1ere";  
char b[8]; // it is better if b is a character array.  
  
StringToUpper(a,b); //b="AB1ERE";
```

#### 14、StringTrim

**[Description]**

split the source2 out from source1,return the result to dest.

**[Usage]**

```
StringTrim(source1,source2,dest);
```

**[Example]**

```
char a[12]="a1erd1esw";  
char *b="1e";  
char c[10];  
StringTrim(a,b,c) //c="ardsw" . It is better if c is a character array.
```

#### 15、StringTrimLeft

**[Description]**

split out any character of source2 in source1,Return the result to the dest.

**[Usage]**

```
StringTrimLeft(source1,source2,dest);
```

**[Example]**

```
char a[8]="aB1edge";  
char* b="be";  
char c[8];  
StringTrimLeft(a,b,c);//c="aB1dg", It is better if c is a character array.
```

## 7.5 Data operation function



| Function name | function   |
|---------------|--|
| GETBIT        | Get bit value.   |
| HIByte        | Retrieve the high byte from the low word of a specified value. |

|               |   |
|---------------|---|
| <b>HIWord</b> | Retrieve the high word from the specified value.        |
| <b>INVBIT</b> | Set specific bit to be inverted (ON->OFF, OFF->ON).     |
| <b>LOByte</b> | Retrieve the low byte from the specified value.         |
| <b>LOWord</b> | Retrieve the low word from the specified value.         |
| <b>SWAPB</b>  | Swap the low byte and high byte of the specified value. |
| <b>SWAPW</b>  | Swap the low word and high word of the specified value. |
| <b>SETBIT</b> | Set specific bit to be ON or OFF.                       |

### 1、GETBIT

**[Description]**

Get bit value.

**[Usage]**

```
result = GETBIT(source, bit_pos );
```

**[Example]**

```
short source = 0x5, bit_pos = 0 ,result;
```

```
result = GETBIT(source,bit_pos); // result == 1
```

### 2、HIByte

**[Description]**

Retrieve the high byte from the low word of a specified value.

**[Usage]**

```
result=HIByte(source);
```

**[Example]**

```
short source = 0x1234,result;
```

```
result=HIByte(source); // result = 0x12
```

### 3、HIWord

---

**[Description]**

Retrieve the high word from the specified value.

**[Usage]**

```
result=HIWord(source);
```

**[Example]**

```
int source = 0x45232568,result;
```

```
result=HIWord(source); // result = 0x4523
```

**4、 INVBIT****[Description]**

Set specific bit to be inversed (ON->OFF, OFF->ON).

**[Usage]**

```
result = INVBIT(source, bit_pos );
```

**[Example]**

```
short source = 0x6, bit_pos =1 ,result;
```

```
result=INVBIT(source, bit_pos); // result = 4
```

**5、 LOByte****[Description]**

Retrieve the low byte from the specified value.

**[Usage]**

```
result=LOByte(source);
```

**[Example]**

```
short source = 0x1234,result;
```

```
result= LOByte(source); // result = 0x34
```

**6、 LOWord****[Description]**

Retrieve the low word from the specified value.

**[Usage]**

```
result=LOWord(source);
```

**[Example]**

```
int source = 0x12345678,result;
```

---

```
result=LOWord(source); // result == 0x5678
```

## 7、SWAPB

### [Description]

Swap the low byte and high byte of the specified value.

### [Usage]

```
result=SWAPB(source);
```

### [Example]

```
short source = 0x1234,result;
```

```
result=SWAPB(source); // result = 0x3412
```

## 8、SWAPW

### [Description]

Swap the low word and high word of the specified value.

### [Usage]

```
result=SWAPW(source);
```

### [Example]

```
int source = 0x12345678, ;
```

```
int result;
```

```
result=SWAPW(source); // result = 0x56781234
```

## 9、SETBIT

### [Description]

Set specific bit to be ON or OFF.

### [Usage]

```
result = SETBIT(source,bit_pos,1);
```

### [Example]

```
short source = 0x4;
```

```
short bit_pos = 1, result;
```

```
result = SETBIT(source,bit_pos,1); // result = 0x6
```



---

## 7.6 Data switch function



| Function name | function                                 |
|---------------|--|
| ASCII2DEC     | Convert a string to a decimal value.     |
| ASCII2FLOAT   | Convert a string to a floating value.    |
| ASCII2HEX     | Convert a string to a hexadecimal value. |
| BCD2BIN       | Convert a BCD value to a BIN value.      |
| BIN2BCD       | Convert a binary value to a BCD value.   |
| DEC2ASCII     | Convert a decimal value to a string.     |
| FLOAT2ASCII   | Convert a floating value to a string.    |
| HEX2ASCII     | Convert a hexadecimal value to a string. |

### 1、 ASCII2DEC

**[Description]**

Convert a string to a decimal value.

**[Usage]**

```
result=ASCII2DEC(source , sizeof(source));
```

**[Example]**

```
char source[4] = {'2', '3', '4', '5'};
```

```
short result;
```

```
result=ASCII2DEC(source , 4); // result=2345
```

---

## 2、ASCII2FLOAT

### [Description]

Convert a string to a floating value.

### [Usage]

```
result=ASCII2FLOAT(source,sizeof(source));
```

### [Example]

```
char source[4] = {'5', '.', '7', '8'};
```

```
float result;
```

```
result=ASCII2FLOAT(source,4); // result = 5.78
```

## 3、ASCII2HEX

### [Description]

Convert a string to a hexadecimal value.

### [Usage]

```
result=ASCII2HEX(source,sizeof(source));
```

### [Example]

```
char source[5] = {'1','6','3','4'};
```

```
short result;
```

```
result=ASCII2HEX(source,4); // result = 0x1634
```

## 4、BCD2BIN

### [Description]

Convert a BCD value to a BIN value.

### [Usage]

```
result=BCD2BIN(source);
```

### [Example]

```
short source = 0x2648;
```

```
short result;
```

```
result=BCD2BIN(source); // result = 2648
```

## 5、BIN2BCD

---

**[Description]**

Convert a binary value to a BCD value.

**[Usage]**

```
result=BIN2BCD(source);
```

**[Example]**

```
short source = 1234;
```

```
short result;
```

```
result=BIN2BCD(source); // result = 0x1234
```

**6、DEC2ASCII****[Description]**

Convert a decimal value to a string.

**[Usage]**

```
result= DEC2ASCII(source,sizeof(source));
```

**[Example]**

```
short source = 5678;
```

```
char *result;
```

```
result= DEC2ASCII(source,4);
```

```
// result[0] == '5', result[1] == '6', result[2] == '7', result[3] == '8'
```

**7、FLOAT2ASCII****[Description]**

Convert a floating value to a string.

**[Usage]**

```
result=FLOAT2ASCII(source);
```

**[Example]**

```
float source = 56.8;
```

```
char result[4];
```

```
result=FLOAT2ASCII(source);
```

```
//result[0] = '5',result[1] = '6',result[2] = '.',result[3] = '8'
```

**8、HEX2ASCII****[Description]**

Convert a hexadecimal value to a string.

**[Usage]**

```
HEX2ASCII(source, result[start]);
```

---

**[Example]**

```
short source = 0x5678;
```

```
char *result;
```

```
result = HEX2ASCII(source);
```

```
//result[0] = '5', result[1] = '6', result[2] = '7', result[3] = '8'
```

## 7.7 Math arithmetic functio



| Function name | function   |
|---------------|--|
| <b>ACOS</b>   | The result is equal to the arcosine of the source.   |
| <b>ADDSUM</b> | Use addition to calculate checksum.                  |
| <b>ASIN</b>   | The result is equal to the arcsine of the source.    |
| <b>ATAN</b>   | The result is equal to the arctangent of the source. |
| <b>COT</b>    | The result is equal to the cotangent of the source.  |
| <b>COS</b>    | The result is equal to the cosine of the source.     |
| <b>CRC</b>    | Get 16-bit CRC.                                      |
| <b>CSC</b>    | The result is equal to the cosecant of the source.   |
| <b>LOG</b>    | Calculate the natural logarithm of a number.         |
| <b>LOG10</b>  | Calculate the base-10 logarithm of a number.         |

|               |   |
|---------------|---|
| <b>POW</b>    | Calculates x raised to the power of y.            |
| <b>RAND</b>   | Produces a pseudorandom number (range:0~65535)    |
| <b>SEC</b>    | The result is equal to the secant of the source.  |
| <b>SIN</b>    | The result is equal to the sine of the source.    |
| <b>SQRT</b>   | The result is equal to the square of the source.  |
| <b>TAN</b>    | The result is equal to the tangent of the source. |
| <b>XORSUM</b> | Use XOR to calculate checksum.                    |

### 1、ACOS

**[Description]**

The result is equal to the arcosine of the source.

**[Usage]**

result = ACOS(source);

**[Example]**

```
float source=0.5;
float result;
result=ACOS(source);
```

### 2、ADDSUM

**[Description]**

Use addition to calculate checksum.

**[Usage]**

checksum=ADDSUM(data, sizeof(data));

**[Example]**

```
char data[5] = {0x1, 0x2, 0x3, 0x4, 0x20};
int checksum;
checksum=ADDSUM(data, 5); // checksum=0x2a;
```

### 3、ASIN

**[Description]**

The result is equal to the arcsine of the source.

**[Usage]**

result = ASIN(source);

---

**[Example]**

```
float source=0.5;  
float result;  
result=ASIN(source);
```

**4、 ATAN****[Description]**

The result is equal to the arctangent of the source.

**[Usage]**

```
result = ATAN(source);
```

**[Example]**

```
float source=1;  
float result;  
result=ATAN(source);
```

**5、 COT****[Description]**

The result is equal to the cotangent of the source.

**[Usage]**

```
result = COT(source);
```

**[Example]**

```
float source=45(度);  
  
float result;  
result=COT(source);    //result = 1
```

**6、 COS****[Description]**

The result is equal to the cosine of the source.

**[Usage]**

```
result = COS(source);
```

**[Example]**

```
float source=60(度);  
  
float result;  
result=COS(source);    //result = 0.5
```

**7、 CRC****[Description]**

Get 16-bit CRC.

**[Usage]**

```
bit_CRC=CRC(source,sizeof(source));
```

**[Example]**

---

```
char source[5] = {0x1, 0x2, 0x3, 0x4, 0x5};
```

```
short bit_CRC;
```

```
bit_CRC=CRC(source,5);
```

## 8、CSC

### **[Description]**

The result is equal to the cosecant of the source.

### **[Usage]**

```
result = CSC(source);
```

### **[Example]**

```
float source=30(度);
```

```
float result;
```

```
result=CSC(source); //result = 2
```

## 9、LOG

### **[Description]**

Calculate the natural logarithm of a number.

### **[Usage]**

```
result = LOG(source);
```

### **[Example]**

```
float source =100,result;
```

```
result = LOG(source); //result =4.61
```

## 10、LOG10

### **[Description]**

Calculate the base-10 logarithm of a number.

### **[Usage]**

```
result = LOG10(source)
```

### **[Example]**

```
float source=100,result;
```

```
result = LOG10(source); //result = 2.00
```

## 11、POW

### **[Description]**

Calculates x raised to the power of y.

### **[Usage]**

```
result = POW(x,y); note:x must be constant
```

### **[Example]**

```
float result,y;
```

```
y=0.5;
```

---

```
result=POW(25,y);    //result = 5
```

## 12、 RAND

### [Description]

Produces a pseudorandom number (range:0~65535)

### [Usage]

```
Random= RAND()
```

### [Example]

```
unsigned short random;  
random =RAND();    //random = 363
```

## 13、 SEC

### [Description]

The result is equal to the secant of the source.

### [Usage]

```
result = SEC(source);
```

### [Example]

```
float source=60(度);  
  
float result;  
result=SEC(source);    //result = 2
```

## 14、 SIN

### [Description]

The result is equal to the sine of the source.

### [Usage]

```
result = SIN(source);
```

### [Example]

```
float source=30(度);  
  
float result;  
result=SIN(source);    //result = 0.5
```

## 15、 SQRT

### [Description]

The result is equal to the square of the source.

### [Usage]

```
result = SQRT(source);
```

### [Example]

```
float source=16;  
float result;  
result=SQRT(source);    //result = 4
```

## 16、 TAN



---

**[Description]**

The result is equal to the tangent of the source.

**[Usage]**

```
result = TAN(source);
```

**[Example]**

```
float source=45(度);  
  
float result;  
result=TAN(source);    //result = 1
```

**17、XORSUM****[Description]**

Use XOR to calculate checksum.

**[Usage]**

```
checksum = XORSUM(source, sizeof(source));
```

**[Example]**

```
char source[5] = {0x1, 0x20, 0x3, 0x48, 0x5};  
short checksum;  
checksum = XORSUM(source, 5);    // checksum =0x6f;
```

## 7.8 Communication function



| Function name      | function                            |
|--------------------|-------------------------------------|
| <b>CLEARBUFFER</b> | Clear buffer of communication port. |
| <b>DELAY</b>       | Set a delayed time                  |
| <b>FillW_8</b>     | Give 8-bit dates to LW register     |
| <b>FillW_16</b>    | Give 16-bit dates to LW register.   |
| <b>FillW_32</b>    | Give 32-bit dates to LW register.   |

|                        |   |
|------------------------|---|
| <b>FillLW_Float</b>    | Give float dates to LW register.                      |
| <b>GETCHARS</b>        | Get data from communication port.                     |
| <b>GETBUFFERLENGTH</b> | Get buffer length from communication port.            |
| <b>PUTCHARS</b>        | Send data to communication port.                      |
| <b>InitEthernet</b>    | TCP/IP client mode initial connect.                   |
| <b>readEthernet</b>    | TCP/IP client mode read receive data.                 |
| <b>writeEthernet</b>   | TCP/IP client mode write send data.                   |
| <b>CountsEthernet</b>  | TCP/IP client mode counts in receive buffer;          |
| <b>ClearEthernet</b>   | TCP/IP client mode delete all data in receive buffer. |

## 1、CLEARBUFFER

### [Description]

Clear buffer of communication port.

PortID--串口 ID,COM1=0, COM2=1。

操作成功返回 1, 失败返回 0。

### [Usage]

```
int CLEARBUFFER(PortID);
```

### [Example]

```
int Clearresult,PortID;
PortID=0;
Clearresult= CLEARBUFFER(PortID);
```

## 2、DELAY

### [Description]

Set a delayed time;

### [Usage]

```
void DELAY(int dwMilliseconds);
```

---

**[Example]**

```
int dwMilliseconds=1000;

DELAY(dwMilliseconds);//延迟 1s.
```

**3、 FillLW\_8****[Description]**

Give 8-bit dates to LW register;

**[Usage]**

```
FillLW_8(&LocalWord[i],a,NULL,count);
FillLW_8(&LocalWord[i],NULL,a,count);
```

**[Example-1]**

```
char a[6]="arsdw";

FillLW_8(&LocalWord[6],a,NULL,5);//LW6='a',LW7='r',LW8='s',LW9='d',LW10='w'.
```

**[Example-2]**

```
char a[6]={1,2,-1,3,4};

FillLW_8(&LocalWord[6],NULL,a,5);//LW6=1,LW7=2,LW8=-1,LW9=3,LW10=4.
```

**4、 FillLW\_16****[Description]**

Give 16-bit dates to LW register.

**[Usage]**

```
FillLW_16(&LocalWord[i],a,NULL,count);
FillLW_16(&LocalWord[i],NULL,a,count);
```

**[Example]**

```
short a[6]={12,1,2,-3,4};
unsigned short b[6]={12,5,4,7,8};

FillLW_16(&LocalWord[0],b,NULL,5);//LW0=12,LW1=5,LW2=4,LW3=7,LW4=8。

FillLW_16(&LocalWord[6],NULL,a,5);//LW6=12,LW7=1,LW8=2,LW9=-3,LW10=4.
```

**5、 FillLW\_32****[Description]**

Give 32-bit dates to LW register.

**[Usage]**

```
FillLW_32(&LocalWord[i],a,NULL,count);
FillLW_32(&LocalWord[i],NULL,a,count);
```

**[Example]**

```
int a[6]={12,1,2,-3,4};
unsigned int b[4]={0x123465,0x541245,0x44444444};

FillLW_32(&LocalWord[0],b,NULL,3);//LW0=1193061,LW2=5509701,LW4=71582788.
```

---

```
FillLW_32(&LocalWord[6],NULL,a,5);//LW6=12,LW8=1,LW10=2,LW12=-3,LW14=4。
```

## 6、FillLW\_Float

### [Description]

Give float dates to LW register.

### [Usage]

```
FillLW_Float(&LocalWord[i],source,count)
```

### [Example]

```
float a[3]={1.2,3.6,4.5};
```

```
FillLW_Float(&LocalWord[8],a,3);//LW8=1.2,LW10=3.6,LW12=4.5。
```

## 7、GETCHARS

### [Description]

Get data from communication port.

### [Usage]

```
GETCHARS(PortID, Data);
```

### [Example]

```
char Data[20];
```

```
int Length,PortID,Result;
```

```
Length=5;
```

```
PortID=0;
```

```
Result=GETCHARS(PortID,Data);
```

## 8、GETBUFFERLENGTH

### [Description]

Get buffer length from communication port.

### [Usage]

```
int GETBUFFERLENGTH(PortID);
```

### [Example]

```
int bufferlen,PortID;
```

```
PortID=0;
```

```
bufferlen=GETBUFFERLENGTH(PortID).
```

## 9、PUTCHARS

### [Description]

Send data to communication port.

---

**[Usage]**

```
PUTCHARS(PortID, Data, Length);
```

**[Example]**

```
char Data[5] = {0x02, 0x30, 0x31, 0x4d, 0x5e};
```

```
int Length,PortID;
```

```
Length=5;
```

```
PortID=0;
```

```
PUTCHARS(PortID, Data, Length);
```

**10、 InitEthernet****[Description]**

TCP/IP client mode initial connect.

IPAdd--server IP address;

networkPort--connect port number;

Success return 1, fail return 0.

**[Usage]**

```
int InitEthernet(char *IPAdd, int networkPort);
```

**[Example]**

```
char *IPAdd="192.168.1.100";
```

```
int networkPort=5;
```

```
int result;
```

```
result= InitEthernet(IPAdd, networkPort) ;
```

**11、 readEthernet****[Description]**

TCP/IP client mode read receive data.

cBuffer--data buffer;

Success return receive counts, fail return -1.

**[Usage]**

```
int readEthernet(char *cBuffer);
```

**[Example]**

```
char cBuffer[]={22,33};
```

```
int result;
```

```
result=readEthernet(cBuffer);
```

---

## 12、 writeEthernet

### [Description]

TCP/IP client mode write send data.

cBuffer--data need to send;

iSize--counts need to send;

Success return 1, fail return 0.

### [Usage]

```
int writeEthernet(char *cBuffer,int isize);
```

### [Example]

```
char cBuffer[]={22,33};
```

```
int isize=8;
```

```
int result;
```

```
result=writeEthernet(cBuffer,isize);
```

## 13、 CountsEthernet

### [Description]

TCP/IP client mode counts in receive buffer;

Success return counts in receive buffer, fail return 0

### [Usage]

```
int CountsEthernet();
```

### [Example]

```
int result;
```

```
result= CountsEthernet();
```

## 14、 ClearEthernet

### [Description]

TCP/IP client mode delete all data in receive buffer.

Success return 1, fail return 0.

### [Usage]

```
int ClearEthernet();
```

### [Example]

```
int result;
```

```
result= ClearEthernet();
```

---

## 7.9 CAN communication function



| Function name               | Function                   |
|-----------------------------|----------------------------|
| <a href="#">onCanxStart</a> | Enable CAN communication   |
| <a href="#">onCanxstop</a>  | Close CAN communication    |
| <a href="#">setBitrate</a>  | Set CAN communication rate |
| <a href="#">addFilter</a>   | Set the ID filter          |
| <a href="#">recvData</a>    | Receive CAN data           |
| <a href="#">sendData</a>    | Send CAN data              |

### 1、onCanxStart

**[Description]**

Enable CAN communication  
Normal return value =0, error return value <0

**[Usage]**

```
int onCanxStart(PortID);
```

**[Example]**

```
int PortID , Result;  
  
PortID = 0; //0: COM0    1: COM1  
  
Result = 0;  
Result = onCanxStart (PortID);
```

### 2、onCanxstop

**[Description]**

Close CAN communication  
Normal returns 0, error returns non-0

---

**[Usage]**

```
int onCanxstop (PortID);
```

**[Example]**

```
int PortID , Result;  
  
PortID = 0; //0: COM0    1: COM1  
  
Result = 0;  
Result = onCanxstop (PortID);
```

**3、 setBitrate****[Description]**

Set CAN communication rate  
Normal returns 0, error returns non-0

**[Usage]**

```
int setBitrate (Bitrate,PortID);
```

**[Example]**

```
int PortID, Bitrate, Result;  
  
PortID = 0;    //0: COM0    1: COM1  
  
Bitrate = 5*1000;    // Set the baud rate 5K set range 5K 10K 20K maximum to 1M  
Result = 0;  
Result = setBitrate ( Bitrate, PortID )// COM0 sets the communication rate to 5000
```

**4、 addFillter****[Description]**

Set the ID filter  
Normal returns 0, error returns non-0

**[Usage]**

```
int addFillter ( CanID, CanMask, PortID );
```

**[Example]**

```
Int PortID, Result, CanID, CanMask;  
  
PortID = 0;    //0: COM0    1: COM1  
  
Result = 0;  
CanID = 0x11;    // Set the filter start ID number  
CanMask = 0x11;    // Set the filter end ID number, and start and end can be the same  
Result = addFillter ( CanID, CanMask, PortID );    // Set to receive only data with CAN ID  
0x11 normally returns 0 error returns non-0 value
```



```

0000 1100 1111 0000 0000 0100 0000 0001 0x0CF00400
0001 1000 1111 1110 1110 0000 0000 0x18FEE00
0001 1000 1111 1110 1111 0010 0000 0000 0x18FEF200
MASK 1110 1011 1111 0001 0000 0001 1111 1110 0x1BF101FE
addfillter(0x0CF00400, 0x1BF101FE, canport);

```

## 5. reciveData

### [Description]

Receive CAN data

Normal return received data length, error return data length <0

### [Usage]

```
int reciveData ( data, Len, PortID, &CanId )
```

### [Example]

```

int PortID, Result, Len;
unsigned int CanId;
unsigned char data[128];          // Receive data buffer

PortID = 0;                       //0: COM0    1: COM1

Len = 128;                         // Receive buffer length
Result = reciveData ( ( unsigned char * ) data, Len, PortID, &CanId );

```

## 6. sendData

### [Description]

Send CAN data

Normal returns 0, error returns non-0

### [Usage]

```
int sendData ( data, Len, PortID, CanId, CanType )
```

### [Example]

```

int PortID, Result, Len, CanType, CanId, i;
unsigned char data[128];

PortID = 0;          //0: COM0    1: COM1

Result = 0;
Len = 8;
CanId = 0x22;
CanType = 0;        // Frame type: standard frame: 0 extended frame:0x80000000
for ( i = 0; i < Len; ++i )
{
    data[i] = i;
}
Result = sendData ( ( unsigned char * ) data, Len, PortID, CanId, CanType );// Standard
frame, COM0 sends data data, length 127,CAN ID 0x22

```

---

## 8. Simulation

---

This chapter mainly introduces usage and steps for offline simulation and online simulation.



“Run SKTOOL as Administrator” is necessary to execute functions of Offline simulation and Online simulation.

### 8.1 Offline Simulation

---

You can check the correctness of the configuration project with the off-line simulation provided by SKTOOL before transferring it to the HMI and connecting the HMI to connected devices.

#### Operation process:

Save the current project, select the offline menu to execute the simulation command, then it appear a pop-up offline simulation window where you can control the project to realize part of HMI functions by clicking the mouse instead of touching the HMI, as shown in Figure 6-1:

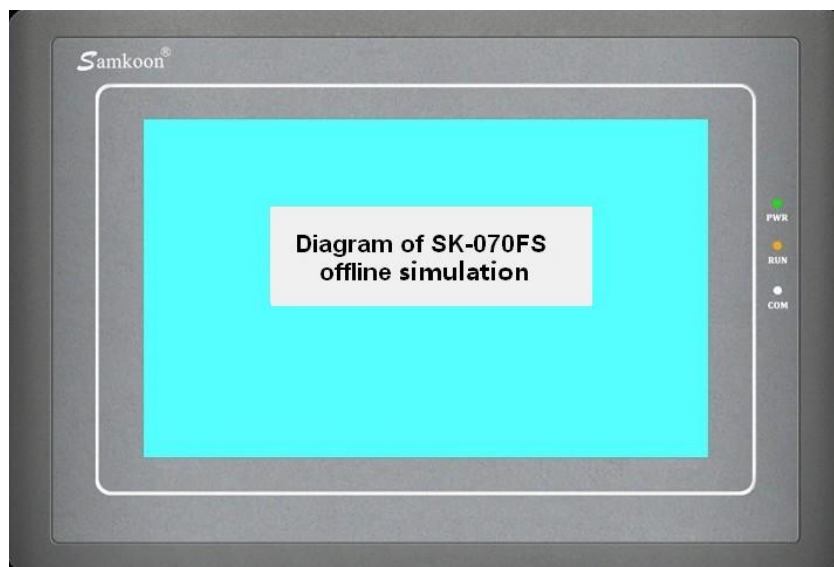
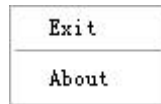

Figure 6-1 Diagram of SK-070FS offline simulation

In the simulation window, right click to bring up the following menu:



- Exit: Close the offline simulation window; press the keyboard ESC can also exit the offline simulation.
- About: About the dialog box.



You can close offline simulation through taskbar “Right Key”-“Close”.

### Offline simulation example

As shown in Figure 6-2, the edited configuration project can be off-line simulated so as to check and find errors in engineering configuration screens, such as whether the monitor address is correct and so on. Just in case.

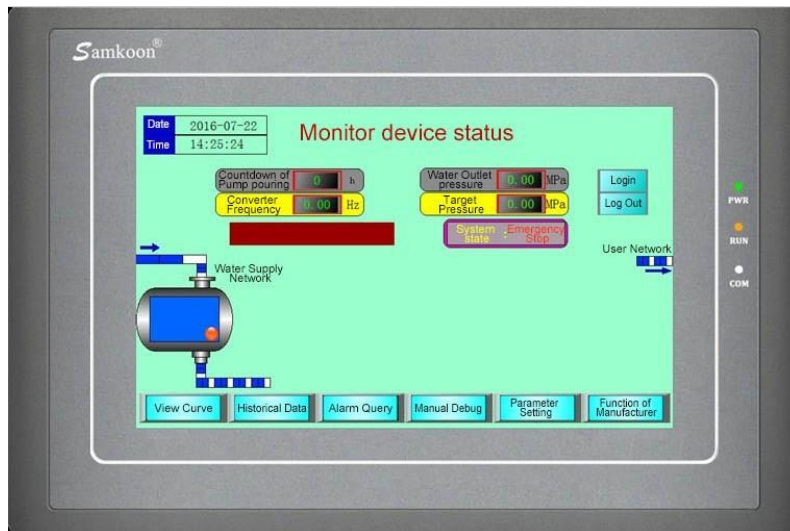

Figure 6-2 Example of SK-070FS offline simulation

### Steps to execute offline simulation:

Install SKTOOL Software first;

Run SKTOOL as Administrator.



## Tips:

Note: In the offline simulation, only these functions of Function button are available: "Previous formula", "Next formula", "Save current formula", "Change User's Level", "Logoff" and "Touch Sound ON / OFF ". The Historical Alarm, Historical Data Display, Historical Trend Graph, Timer, and Macro on the Toolbar cannot be simulated.

The other controls are the same operation. After setting properties of each control, click "Save" and then select Offline simulation, as shown in Figure 6-3:

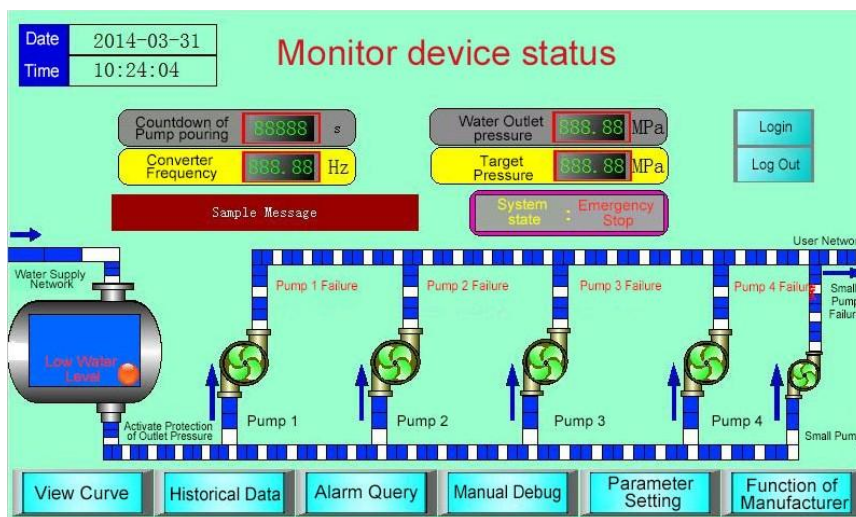

Figure 6-3 Offline simulation

## 8.2 Online Simulation

Online simulation allows communicating between PC and PLC or other related devices without SK HMI. It is employed to debug the configuration project and conduct testing work when the HMI fails through simulating its operation status. Refer to offline simulation for configuration editing.

Online simulation requires the connection to PLC, so it needs to ensure that the cable connecting PLC and PC functions properly. The online simulation runs in 30 minutes, after that, it will quit automatically.



Note: It is the download cable that is needed for common PLC, but not that connecting PLC to HMI.  
Please contact technical support staff in case of communication failure.

---

## 9. System Settings

---

This chapter introduces setting functions of SKTOOL system. It is necessary to set them up in order to ensure normal running of HMI, including that of PLC.

### Contents:

- [Communication Port Property](#)
- [Setting](#)
- [Screen](#)
- [Window](#)
- [Historical Data Collector](#)
- [Alarm settings](#)
- [Formula](#)
- [Data Transmission](#)
- [Global Macro](#)
- [Init Macro](#)

### 9.1 Communication Port Property

---

Communication port property is applied to set the communication parameters between HMI and connected devices. HMIs like SK-121F, SK-104F, SK-102H, SK-102C, SK-070G, SK-070M, SK-070F, SK-070H are equipped with two communication ports, COM1 and COM2, supporting simultaneous communication with two different PLCs; and parameters of each port must be set. HMIs like SK-050H, SK-043U, SK-043F, SK-043H, SK-035U, SK-035F have one communication port, COM1, and it communicate only with one connected device.

Double click "Link" and " Link 1", as shown in Figure 7-1:

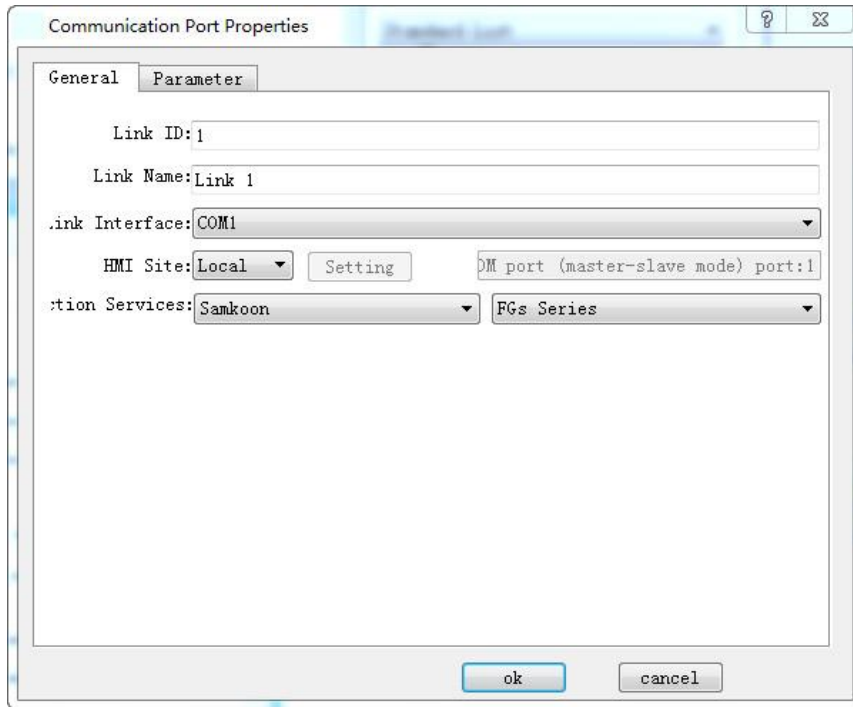

Figure 7-1 COM1 COM port property dialog box

In the "Link" page, various brands and models of PLC are available. In addition, the "Link name" and "PLC consecutive address interval"

Click the Parameter tab of the dialog box, as shown in Figure 7-2:

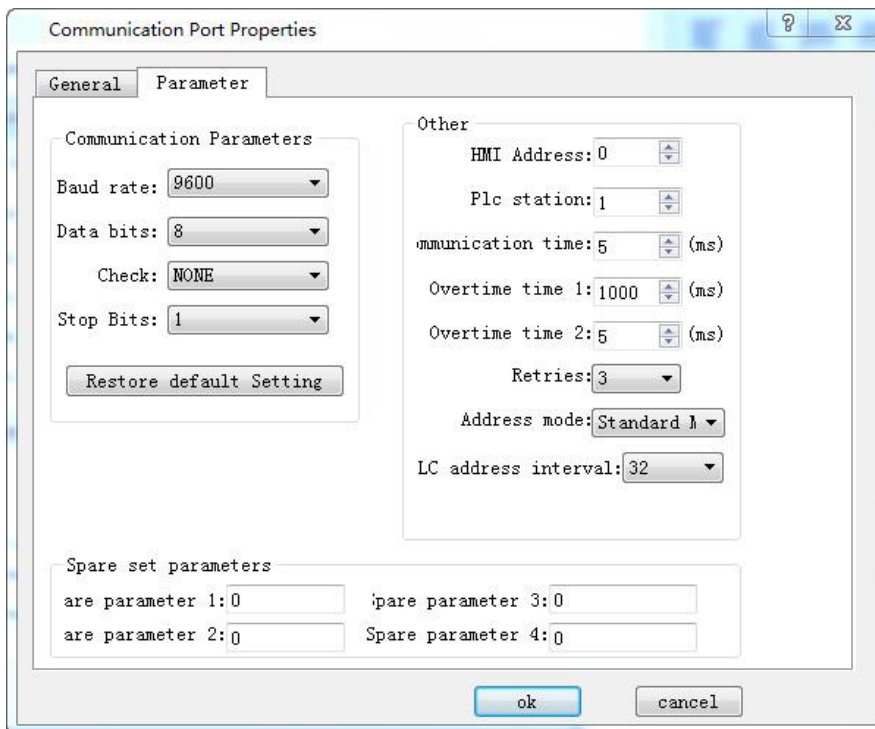

Figure 7-2 COM1 Communication port parameter setting

**Parameter settings:**

---

Equipment services: manufacturer, PLC brand and CPU model.

Port: RS232 / 485/ 422

Baud rate: 1200/2400/4800/9600/19200/38400/57600/115200 / 187.5k

Check: Odd / Even / None

Data bits: 7/8

Stop bits: 1/2

Model: PLC model

HMI station number: Set the station number of the HMI

Communication time: HMI sends data to the PLC and receives the data from PLC, and it cannot send data again until after the set communication time.

Overtime time 1 and Overtime time 2: Calculate first the value of Timeout 1 divided by that of Timeout 2, as shown in the figure above: the timeout period is 200ms. There is a situation called timeout if the HMI has not received the data 200ms after sending data.

Number of retries: The number of times that the data is retransmitted after a timeout

Address mode: ① Standard mode: One serial port connects one PLC; ② Extended mode: One serial port connects multiple PLCs of the same type

PLC Continuous Address Interval: The maximum number of words that PLC can read at one time

## 9.2 Setting

---

Let's come to some settings of HMI. It is also important for project configuration. We can change HMI system settings in a narrative way to achieve the expected effect of users.

### Contents:

- [Language](#)
- [HMI parameter settings](#)
- [HMI State](#)
- [PLC Control](#)
- [Clock](#)



- [File Encryption](#)
- [HMI Protection](#)
- [Variable Table](#)
- [Text Library](#)
- [Address Library](#)

### 9.2.1 Language



Language: This function realize multiple languages; it is necessary to preserve languages employed in configuration in character library of PC.

Double click the Language option or right click to open the dialog box of Language Setting.



Language total: Set total number of the system language, at most fifty languages. Article 50 the biggest

Language Name: Set a name for each language.

Example:

1. As shown above, set the total number of languages to 3, and the language name is by default; create a new text input control, such as Screen button, select Language 1 in the language drop-down box, enter in the text box "lang1", and then set the parameters of font size and color, etc.; select Language 2 in the language drop-down box, then enter "lang2"; select Language 3 in the language drop-down box, then enter in the text box "lang3", as shown below:

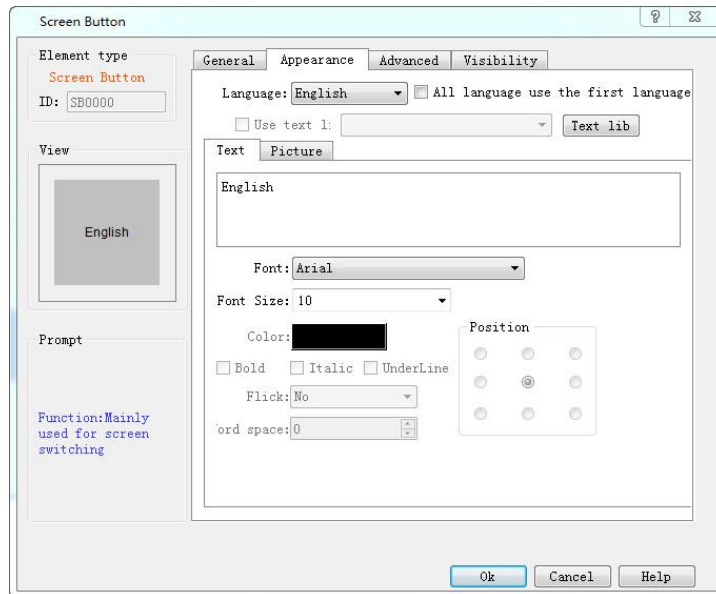

2. Click "OK" after the settings, and then left click on the screen to add this Screen control button when the mouse cursor shows a cross shape; adjust its size. It should note that "Function" options below "General" page of each button are the same: "Switch language"; while options of "Language" are different: Language1, Language2 and Language3, respectively.

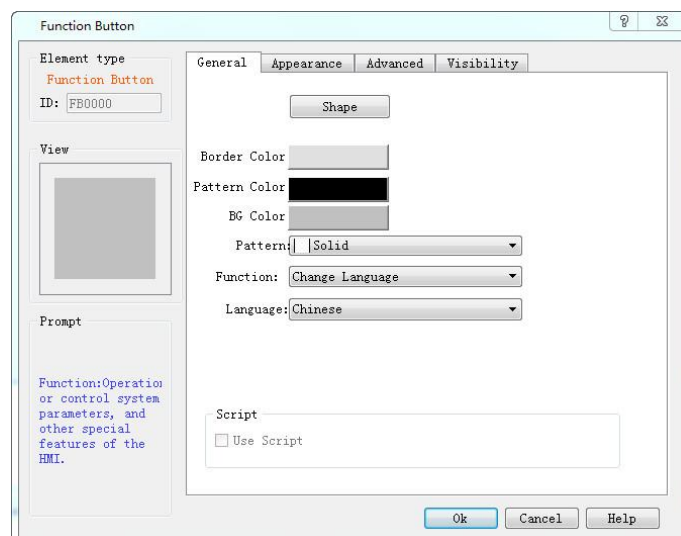

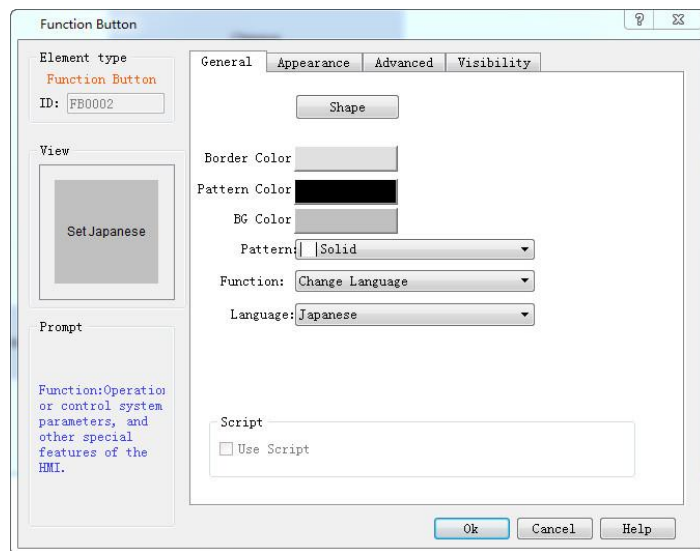
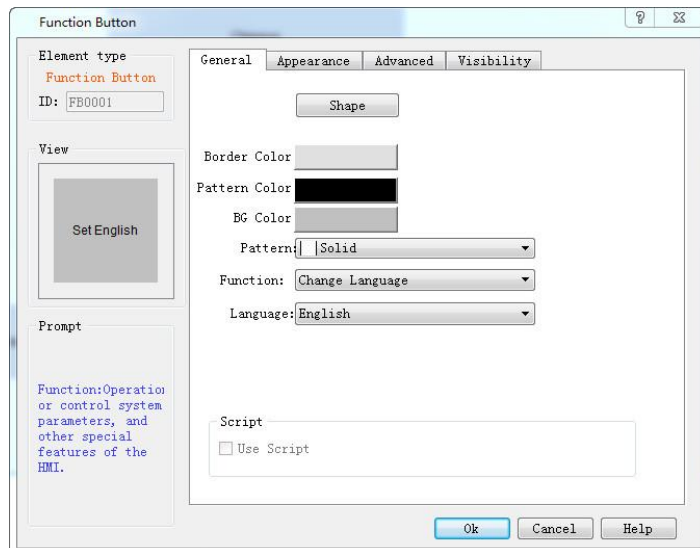

3. Save the project after the settings, as shown below:



3. Simulate (or download to HMI)

---

All controls with text will be presented in the according language when click Function button 1, 2 or 3.

As shown below:

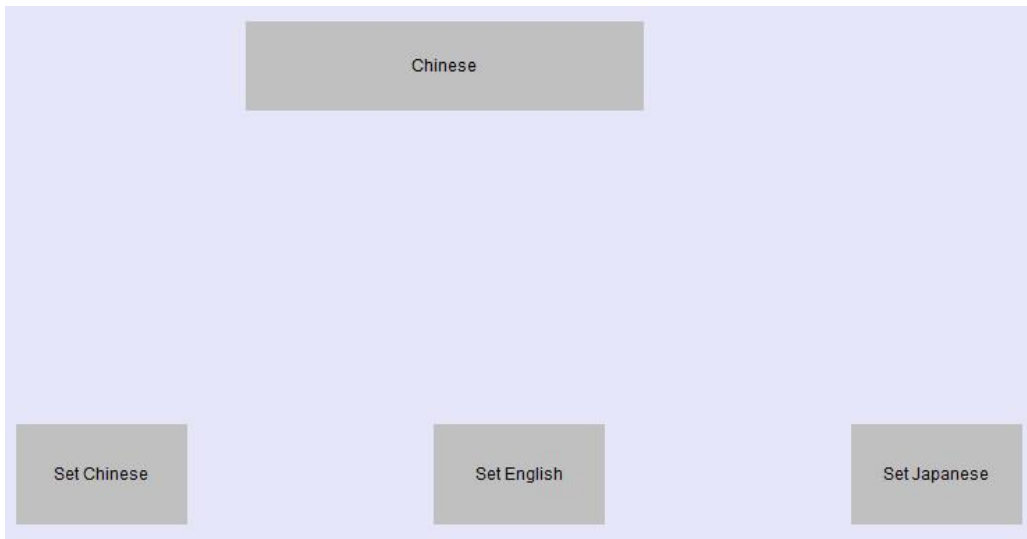

The figure above shows the state after clicking Function button 1 to switch the language to Set Chinese

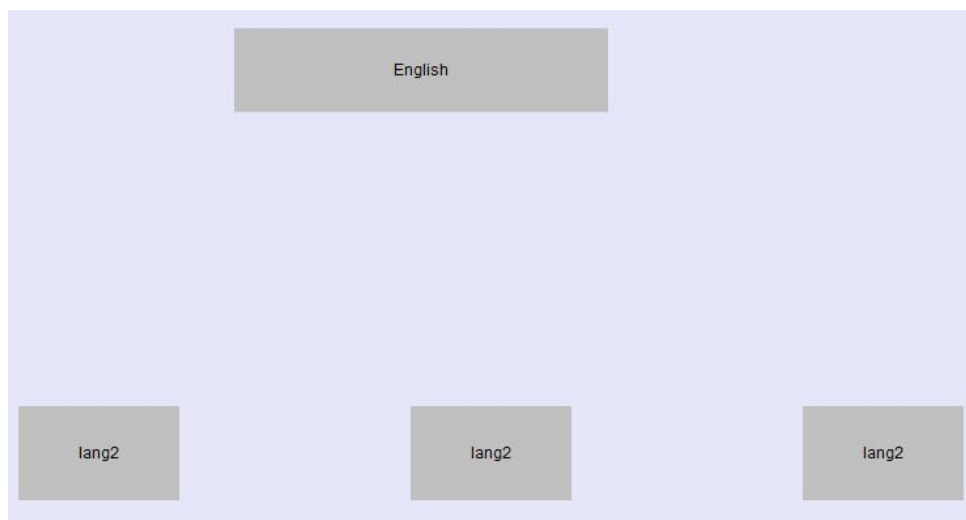

The figure above shows the state after clicking Function button 2 to switch the language to Set English.

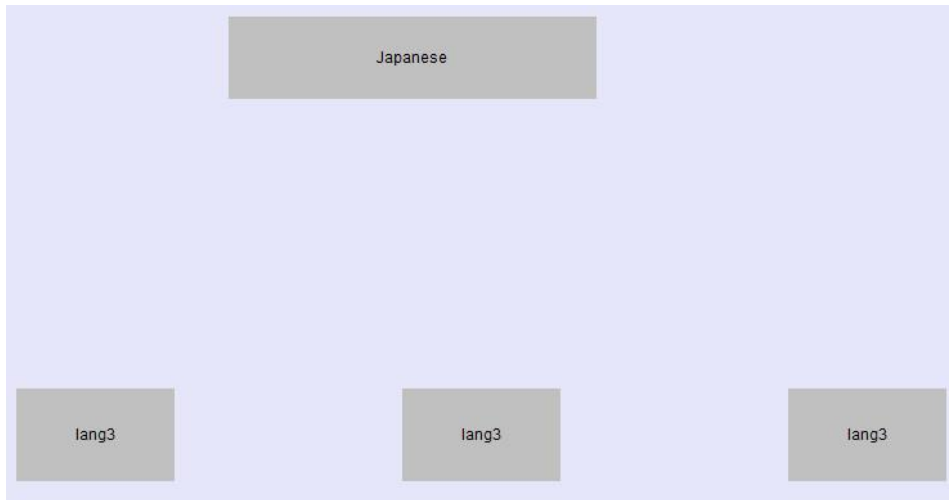

The figure above shows the state after clicking Function button 3 to switch the language to Set Japanese.

To achieve the multi-language function in the entire project, it is necessary to input different texts for each control or object with text (same operation with the first point). This enables the entire project to be switched to the specified language when execute the command of "Switch Language".

## 9.2.2 HMI parameter settings



HMI model can be assigned when create a project or be modified during the configuration through HMI parameter settings in the Project Manager.

Double click "HMI Parameter Setting: in the Project Manager, then a dialog box pops up, as shown in Figure 7-3:

### Parameter Setting:

1. You can modify the parameter settings through Preference Setting in the drop-down menu Settings, or double-click the HMI Parameter Settings in Setting, Project Manager. Then a pop-up dialog box is shown as Figure 7-3 below:

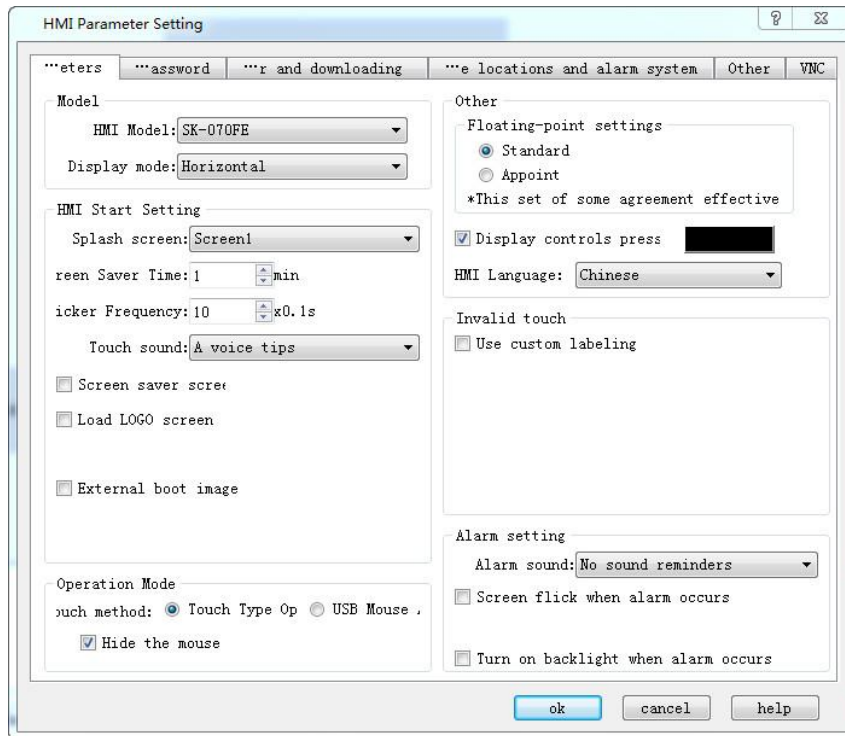

Figure7-3 HMI Parameter Setting dialog box

HMI Model: Change model of HMI

Model instruction:

E.g.: SK-070FS

SK: Samkoon SK series

070: Display size of HMI

F: F Type; there is also H type; different types have different resolution.

S: Standard type; also E for Economy HMI

Display mode: Adjust horizontal or vertical display screen.

HMI Start Setting

Splash screen: The start screen of HMI when powered on

Screen Saver Time: Set screensaver time

Flicker Frequency: Set the flicker frequency of objects or controls which can blink; you can change the speed of flicker by inputting directly a value and clicking the spin button.

Alarm sound: When the alarm occurs, the touch screen can remind users through sound; the right drop-down menu contains two cases, with or without sound reminder.

Touch sound: Options in the right drop-down menu can decide Sound reminder or No sound reminder.

Screensavers screen: Select a screen among the existing screens as screensaver screen; just touch the screen to return the former screen.

If Load Screen: If choose this option, the HMI will display the selected loading screen after power-on for a certain while, and then switch to the splash screen; thus users can give some tips or notes.

Screen flicker in case of alarm: switch background colors between that of Alarm control or Alarm Bar and screen background color; flicker frequency is in accordance with the above. This function

doesn't work when the background is a picture or the background pattern is transparent.

- Other settings
- Hide mouse cursor: Whether to display the mouse
- Floating-point settings:
  - [Standard]: High byte floating point ahead while the low one behind;
  - [Appoint]: users determine the order.
- Invalid touch: Select the "Use custom labeling", which means touchable controls cannot be touched, then the picture marking the control chosen by user is untouchable.
- Operation Mode: Choose one mode between traditional touch operation and USB mouse operation.
- Display controls pressing effect: SKTOOL is newly added pressing effect display. When the pressing effect is applied, rectangular pressing trace will appear if users touch the control. The pressing trace color depends on user's preference. Currently Bit switch, Word switch, Screen button, Function button, Numeric input and ASCII input controls support this effect. The default is No effect.



Note: Pressing effect of elliptical controls is still a rectangle.

## 2、 Set user password:

HMI Parameter Setting

parameters password upload and downloading file locations and alarm system Other VNC

User 1  
 Use

User 2  
 Use

User 3  
 Use

User 4  
 Use

User 5  
 Use

User 6  
 Use

User 7  
 Use

User 8  
 Use

Default user level: NULL

Allows uploading configuration

Supreme authority password

Enter the password when update configuration

Password when updating configuration through

ok cancel help

Figure 7-4 Set User Password

- This function supports 8 sets of user password, each of which has eight levels of password for users to choose.
- The default user level: The current default user class is NULL.
- Allow uploading configuration: If select this option, you can upload the project from HMI to PC; otherwise it cannot be uploaded.
- Enter the password when uploading: Whether uploading projects requires a password.
- Password when updating configuration through U disk: The password set up, the password is necessary when you update the HMI configuration projects through U disk.
- Supreme authority password: This password can operate all controls limited by grades.
- Upload: Whether this password enables upload configuration projects from HMI to PC.
- Permissions: Whether this password can perform all limiting operations.

### 3、 Settings of connection to the printer and downloading

Click "Settings of connection between HMI and printer" button, as shown in Figure 7-5:

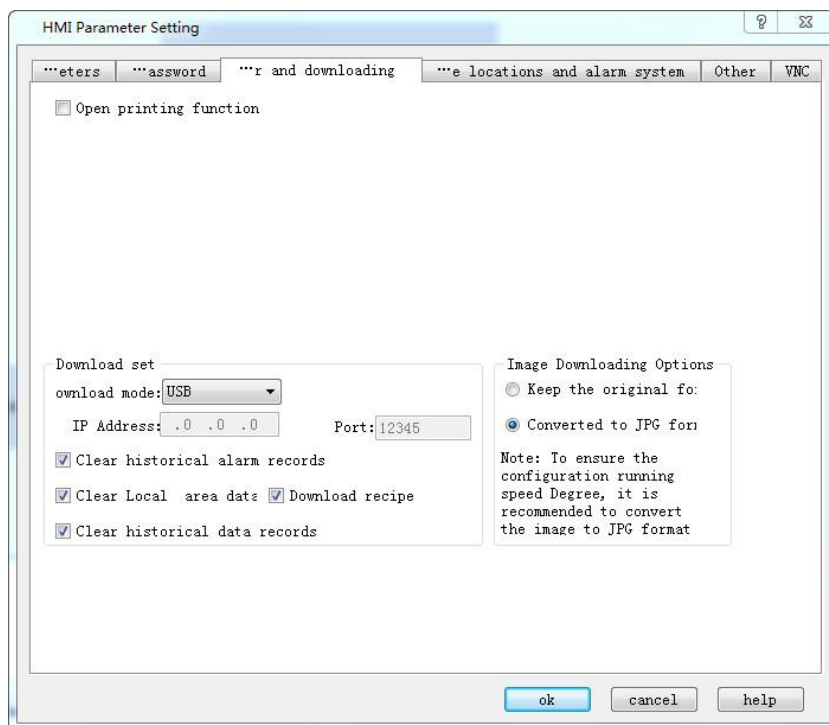

Figure 7-5 parameter settings of connection between the printer and the HMI

This page contains parameter settings of connection between the printer and the HMI; users can select corresponding parameters according to printer models.

Download settings:

Download mode: Users need to select USB or Ethernet connection to download. If choose the



---

Ethernet, it's necessary to set the IP address and port number (IP address and port number are those of the HMI).

Clear historical alarm records: Whether to clear the history alarm information before downloading.

Clear historical data records: Whether to clear the history data information before downloading.

Download Formula: Whether to download formulas in the current project to the HMI.

#### Image Downloading Options:

Keep the original format: Selecting this option means retain the image format unchanged when downloading.

Convert to JPG format: Convert all images to JPG format before downloading them into HMI.

(Note: Due to the larger space occupied by BMP format images, it's suggested to select this option.)

#### 4. Storage location and alarm system, as shown below

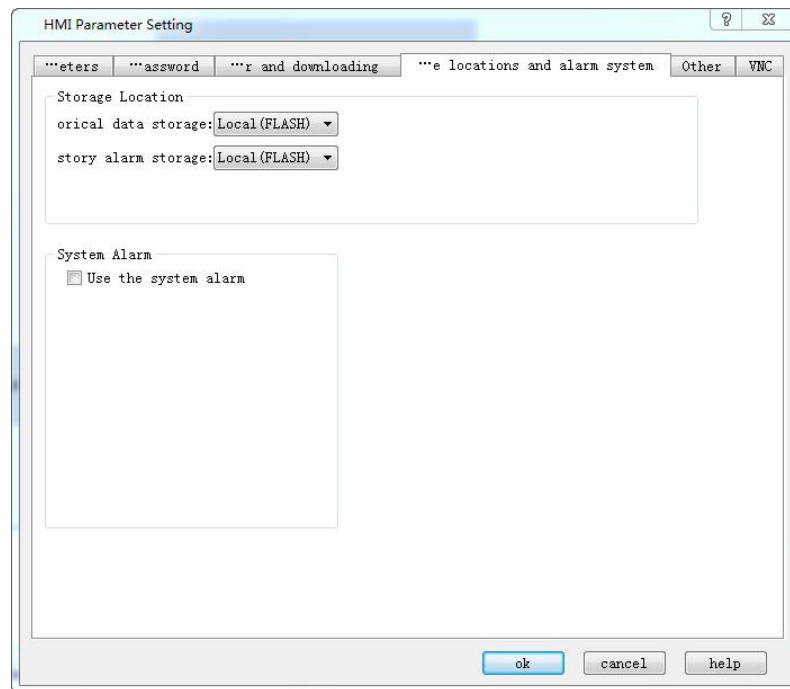

Figure 7-6 Storage location and Alarm system

- Storage location: Location for historical data, historical alarm and screen shots. Provide "Local (FLASH)", "U disk" three options for users to choose according to their need. The default is Local (FLASH).
- Alarm system

- 
- Use the alarm system: Whether to use the system alarm. When an alarm occurs, the alarm system displays the current alarm information at the top or bottom of each screen according to the options set by users.
  - Alarm background color, Text color, Font and Font size, these are attributes options of the alarm display system. Users can set these options as needed.
  - Way of display: "Always display" refers to the alarm displayed all the time; "Cyclic display" means that alarm display or disappear within a certain period to achieve the flicker effect.
  - Position of alarm bar: Choose the position where the alarm bar appears.

### 5. Other, as shown below

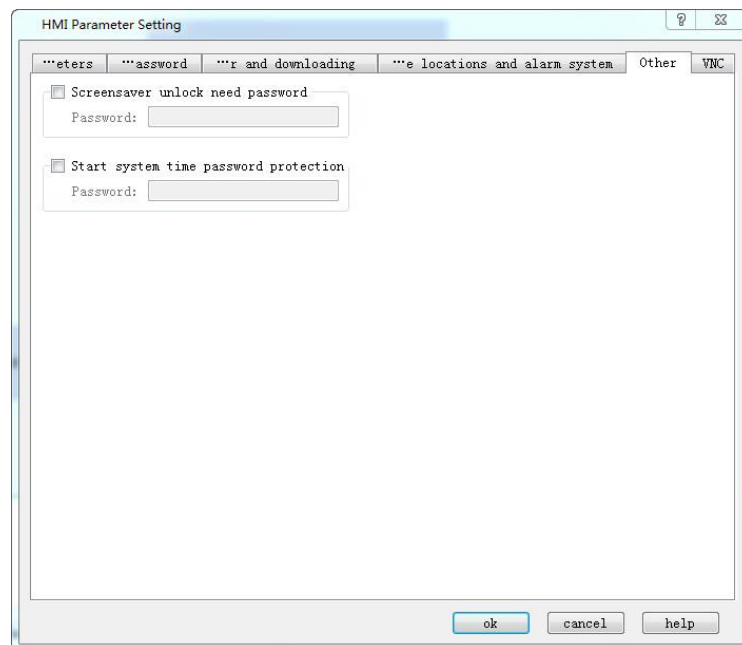
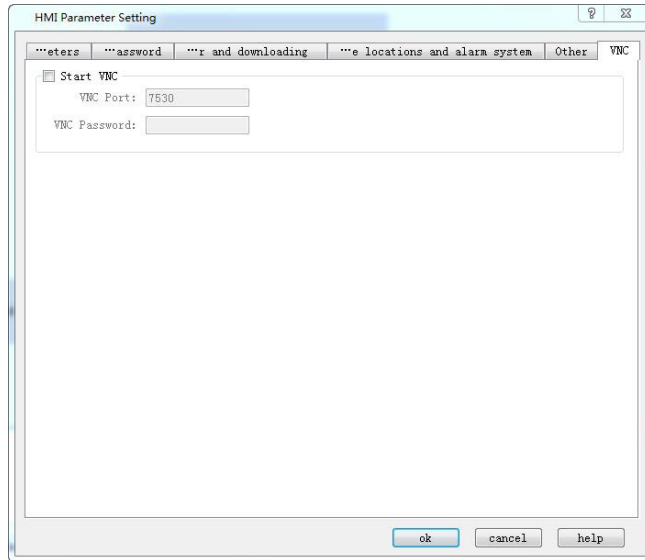

Figure 7-6 Screensaver unlock password

Use the Screensaver unlock password,when unlocking screensaver,need to input the correct password as the edit.

### 6. VNC



VNC port and password

The special type supports remote connection touch screen, and then after the first option is enabled, the user can log in to the touch screen to monitor the current touchscreen group state.



### Tips:

Note: Change of the screen saver time is not valid until "Screensaver screen" is chosen; just touch the screen of screensaver to return to the former screen.

## 9.2.3 HMI State



HMI state setting is employed to write the current HMI state information to the data register of PLC.

Double click the "HMI State" item in the Project Manager, a dialog box will pop up as shown in Figure 7-7:

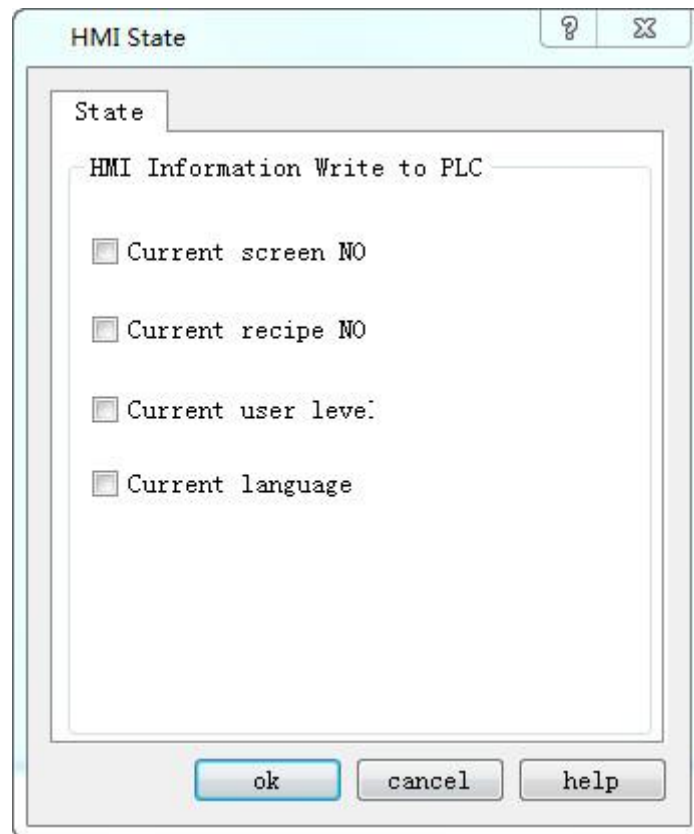

Figure 7-7 HMI Status Setting

- Current screen NO: Write the serial number of the current HMI screen to the PLC.
- Current formula NO: When the serial number of the current formula to the PLC.
- Current user level: Write the current user level to the PLC.
- Current language: Write the serial number of the currently applied language to the PLC

Click "OK" HMI to complete the settings.

## 9.2.4 PLC Control

---

PLC control means realizing operations of screen switching, change user level, change formula and write formula through PLC. Double click "PLC Control" in the "Project Manager", the dialog box shown in Figure 7-8 will pop up:

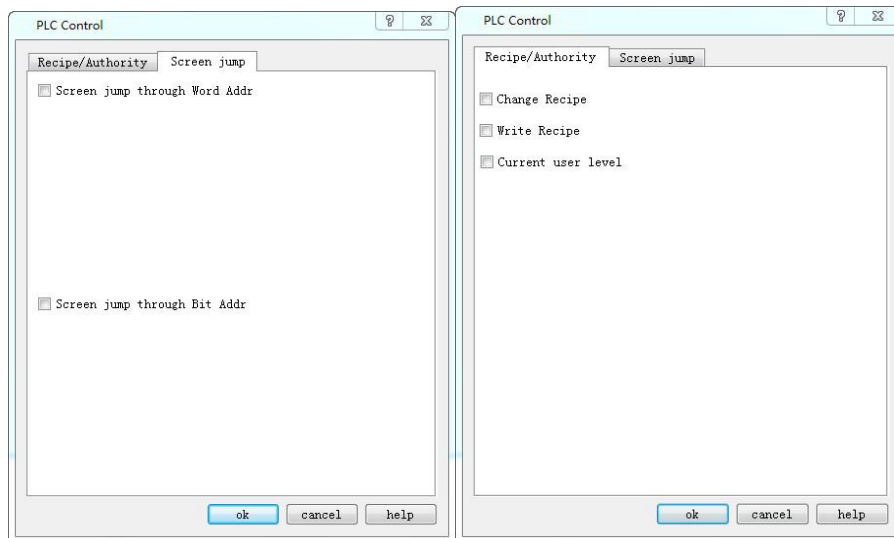
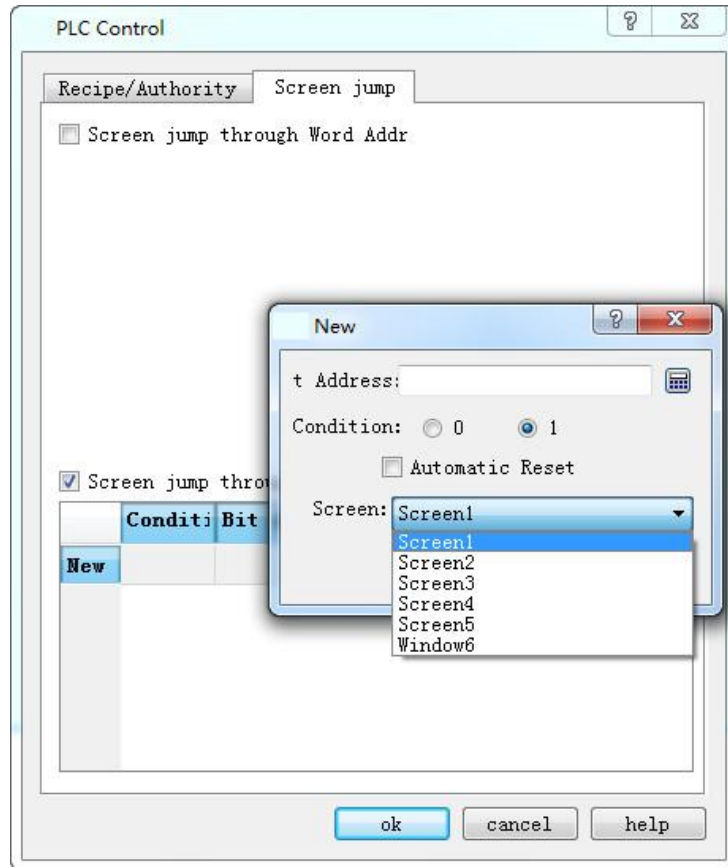

Figure 7-8 PLC control dialog box

- Change formula: HMI changes the formula according to its address value.
- Write formula: HMI controls the write of the formula based on its address value.
- Current user level: HMI controls the current user level according to this address value.
- Screen switch through Word address: Control screen switch through the word address. HMI switches the screen according to this word address value; if the address value is n, it jumps to the nth screen.
- Screen switch through Bit address: Double click the "New" line; a pop-up dialog box will appear as shown in Figure 7-9:

New bit control panel:



New word control screen

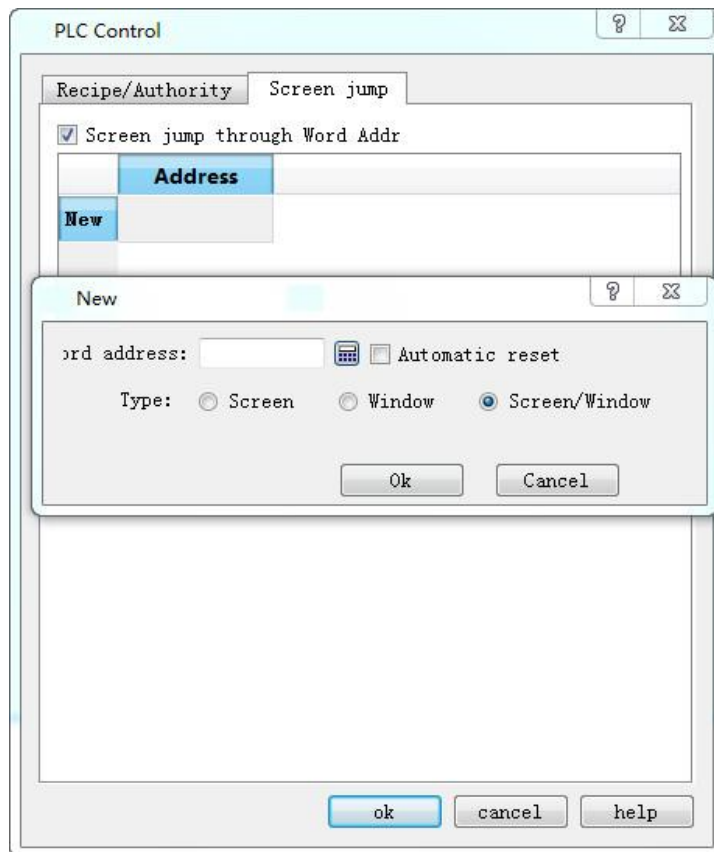

Screen: PLC word control can only jump between pictures

---

Windows: PLC word control can only jump between windows

Screen / window: PLC character control jumps between picture and window



Note: When switch screens through PLC, the value read for the first time does not affect the screen switching. It functions only when the value of PLC register is different from the first read value.

## 9.2.5 Clock

---

Clock setting includes three functions: downloading system time to HMI, writing time to PLC and synchronization with PLC.

Double click "Clock" in the Project Manager to open the attribute setting box of Clock.

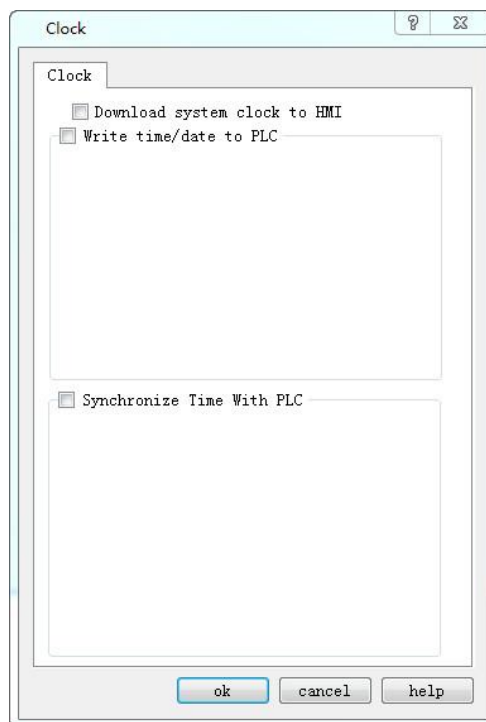

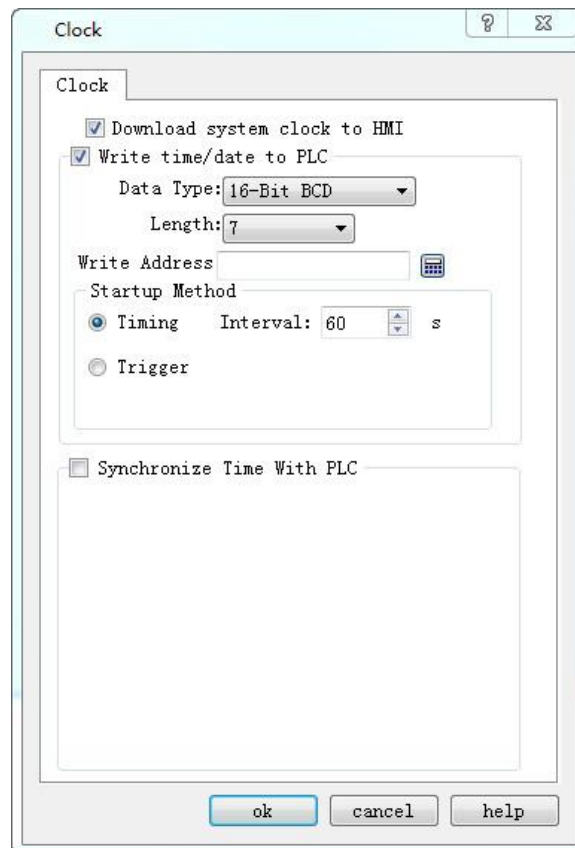
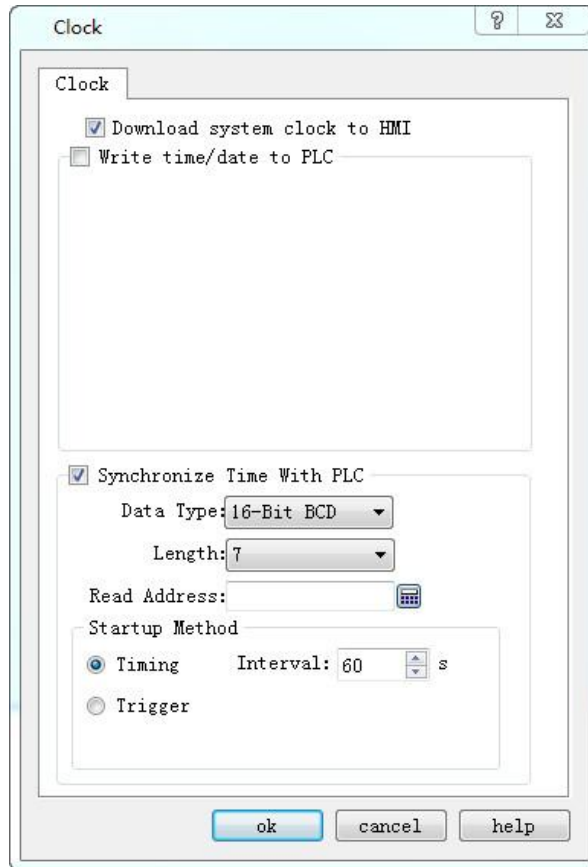

Figure 7-11 Clock Setting dialog box



---

Download system clock to HMI: Whether to download the system clock information to HMI.

- Write time/date to PLC:
  - The Data type and Length are default values.
  - Time: Year-Month-Day-Hour-Minute-Second-Week. Refer to LW 60000~LW 60006 in Register Address for detailed information. It cannot modify the Week in the system time.  
Write address: The system time information will be written into this PLC address.
  - Startup Method:  
Timing: Write the system time information into the specified PLC address periodically at specified time interval.  
Trigger: The system time information will be written into the specified PLC address when the trigger address is 1.  
Auto Reset: Reset automatically the trigger address to 0 when it is 1.

**Synchronization with PLC time:**

- The Data type and Length are default values.  
Time: Year-Month-Day-Hour-Minute-Second-Week. Refer to LW 60000~LW 60006 in Register Address for detailed information. It cannot modify the Week in the system time.
- Read address: The information in the PLC address will be read.
- Startup Method:  
Timing: Write the system time information into the specified PLC address periodically at specified time interval.  
Trigger: The system time information will be synchronized with the PLC when the trigger address is 1.  
Auto Reset: Reset automatically the trigger address to 0 when it is 1.

## 9.2.6 File Encryption

---

Whether a password is necessary to open the project file.

Double click the "File Encryption" option in the "Project Manager", as shown in Figure 7-12 pop-up dialog box:



Figure 7-12 File Encryption dialog box

Select the "Use password to protect file" in the above dialog box; enter in the Password and Confirm Password; click "OK" to complete.

In this case, if user reopens the project, a password input box will be displayed as shown in Figure 7-13:

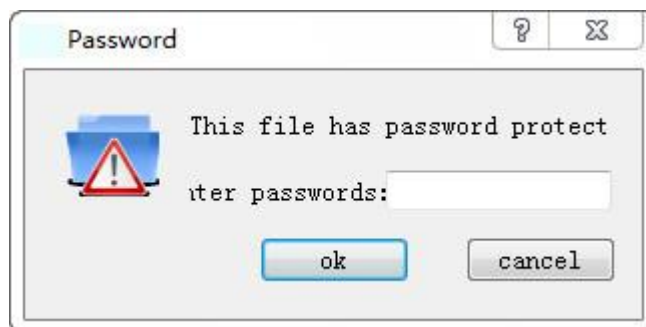

Figure 7-13 Password input box

Users need to input secret to open project.

## 9.2.7 HMI Protection



HMI protection is mainly employed to set a certain period of time during which HMI can functions

---

normally. If the time is beyond the set period, HMI will jump to a specify screen where a password is necessary to re-use the HMI.

Double click the "HMI protection" option in the "Project Manager" to pop up dialog box shown in Figure 7-14:

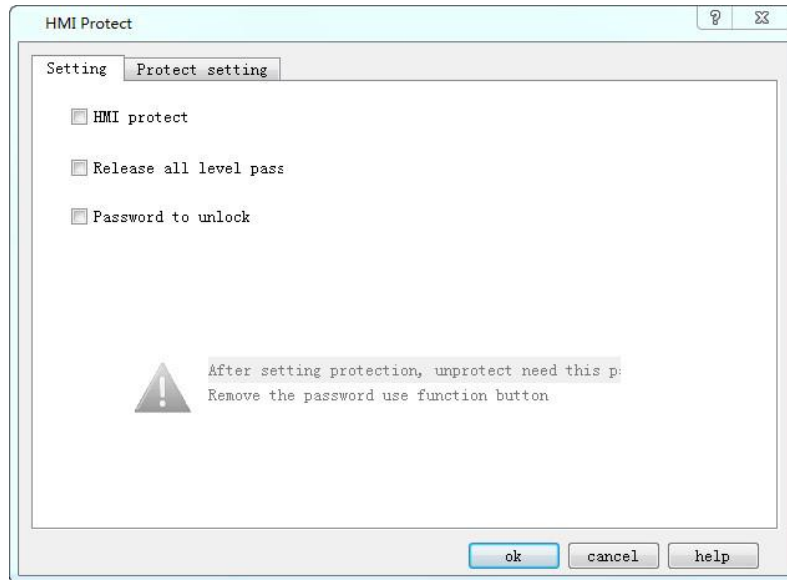

Figure 7-14 HMI Protection dialog box

Example to illustrate the application of this function:

- Select "Password to unlock": A password is required to enter the HMI protection the next time.
- Select "Release all level pass": If input this password when unlocking HMI protect, it would release all the HMI protect level.
- Select "HMI Protect": automatically go to "Protect setting" page, as shown follow:

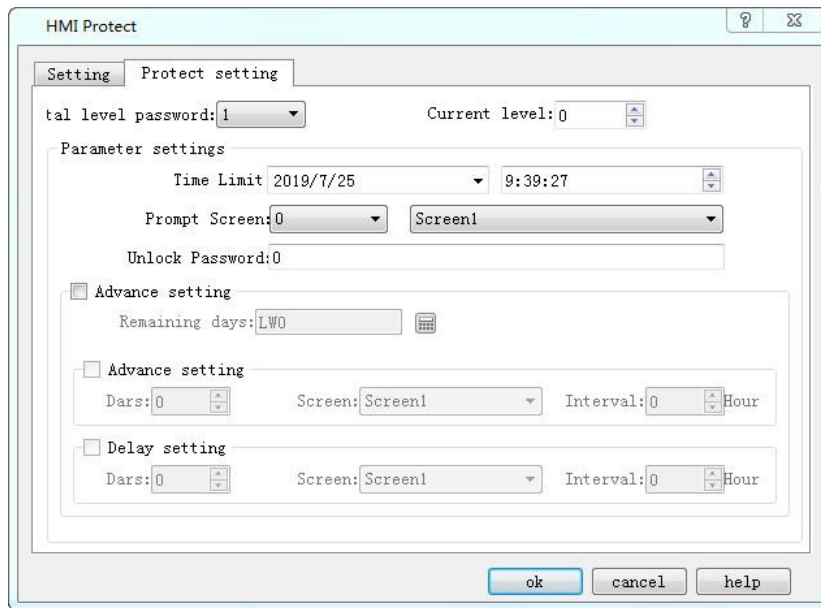

Figure 7-15 HMI Protection Setting

Set the "Total level password" to 3; select the 1 button icon, choose 2009-04-01 and 12-00-00 in the Time Limit column under the "Parameter settings"; decide the screen 1 as the "Prompt Screen"; Set "Password to unlock" to 1111. Then the level 1 protection is set up.

As in the above case, set the time limits and passwords for level 2 and level 3.

- removes all ranks

After enabling this feature and setting the password, the password set at this location can remove all levels of the HMI protection setting

- startup password protection

After enabling this function and setting the password, you need to input this password to turn on HMI protection the next time to view HMI protection information

- enable password protection

Enabling this feature will enable HMI protection. The specific information is set in the protection Settings.

- protection Settings

Total password level: up to 15 levels of HMI protection for different periods of time as required

Current password level: the following parameters are set for the current password level

---

Parameter Settings:

Term of use: HMI protection expiry date

Deadline prompt screen: prompt screen when HMI protection expires

Unprotect password: the password that is unprotected by HMI when it expires

Advanced Settings:

View the remaining days: see the remaining days that are now up to the HMI protection set lifetime

In advance:

Set the distance between the remaining set days of HMI protection service life and the HMI protection service life

Delay:

After setting the HMI protection service life to set the number of days, the interval specified time prompts the specified screen

Advance and delay priorities

Advance selection, delayed selection, effective in advance

No selection in advance, delay selection, delay effective

Advance selection, delay selection, function button HMI protection delay unlock is not used, it is effective in advance

Advance selection, delay selection, function button HMI protection delay unlock, delay effective

➤ illustrates the function of the method of use:

Suppose the total number of password levels we set in this dialog is 3;After that, select 0 in "current password level". In "parameter setting", select the date of use in the "usage period" column. Suppose to select 2009/04/01 here.Enter the usage time in the next column, assuming the option is 12:00:00;Select the screen when the deadline arrives in the "deadline prompt screen" option, assuming that it is screen 1;Enter the password needed to unprotect the password when "unprotect password", assuming 1111.Level 1 HMI protection setup completed.

again, at the level of the "current password" selected 1, inside the "parameter setting", in the "service life" column choose to use date, suppose in the choose the 2009-04-05;Enter the usage

---

time in the next column, and suppose to select 12-00-00;Select the screen when the deadline arrives in the "deadline prompt screen" option, assuming that it is screen 2;Enter the password needed to unprotect the password when "unprotect password". Suppose it is 2222.Level 2 HMI protection setup completed.

again, at the level of the "current password" selected 2, inside the "parameter setting", the "service life" column choose to use date, suppose in the choose the 2009-04-10;Enter the usage time in the next column, and suppose to select 12-00-00;Select the screen of time limit prompt screen in the option of "deadline prompt screen", and suppose it is picture 3.Enter the secret required to unlock the password protection when "unprotect password", assuming 3333.Level 3 HMI protection setup completed.

3 HMI protection Settings after click "ok" button.

Suppose today's date is 2009-04-01, the time is 08-00-00, because the use period of level 1 HMI protection set before this time is 12-00-00 of 2009-04-01. Since the deadline has not arrived, this HMI can still be used normally.Suppose after 4 hours, the time is 12-00-00 of 2009-04-01. At this time, HMI will automatically jump to the screen set by the user for this period.The user wants to continue to use the HMI, to HMI to can operate on other images, the user can in the picture (picture 1) add a function button and select "remove HMI lock" function in the button, when the level 1 HMI protection using the time to use, click the function button, and input the password in the pop-up box input level 1 password protection solution, in this input 1111 can remove password protection.

When level 1 HMI password is unblocked, HMI can be used normally.Hypothesis for a period of time, the time is 12 2009-04-05-00-00, because now it's time to set the level 2 HMI protection, so the HMI automatically adjust to the HMI set protection screen (picture 2), by the same token, the user need to use the function button and select the "cancel the HMI lock" function button function, input level 2 password protection (2222), HMI can normal use.

Because we set level 3 HMI protection here, similarly, when the time is 12-00-00 of 2009-04-10, the user needs to use the function button and select the "unlocking HMI" function in the function button. Enter the level 3 unlocking protection password (3333), and HMI can be used normally.

HMI protection fails when all level 3 passwords are unblocked.HMI can be used normally.

The above examples illustrate the use of HMI protection function. For setting different

---

password levels, the operation is similar. Users can refer to the above.

## 9.2.8 Variable Table



Define a tag with an address. When the tag is employed, it corresponds to the corresponding address. To configure the variable settings, double click the "variable table" option in the "Project Manager", then a dialog box will pop up as shown in Figure 7-15:

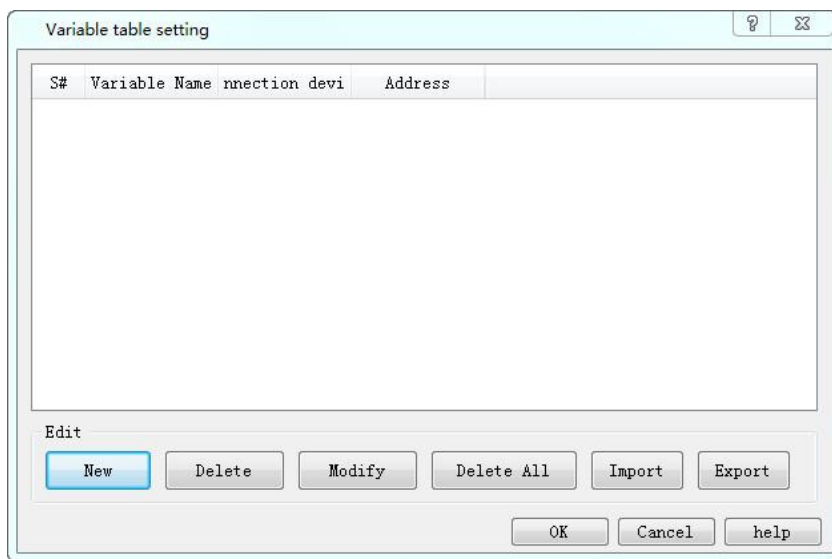

Figure 7-15 Variable Table Setting Dialog Box

- New: Add a new tag; the maximum total number is 1000
- Delete: Delete the selected tag.
- Modify: Modify the selected tag or double click the selected tag.
- Delete all: Delete all variable tags.
- Import: pop up a open file dialog,import variable table file.
- Export :pop up a save as dialog,Export current variable table.

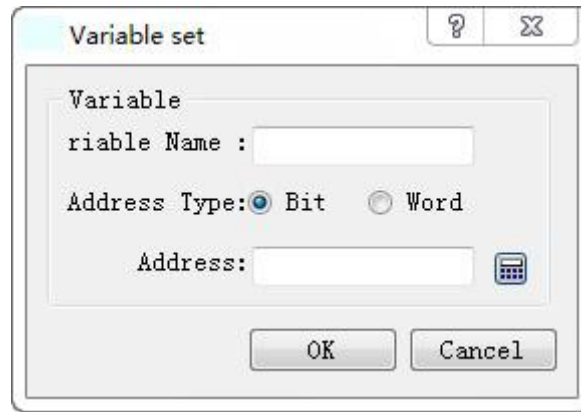

Figure 7-16 Create a screen switch through bit control dialog box

- Variable name: Set the name of the newly created variable.
- Address Type: Select the data type of the address.
- Address: Select the address of the connection.

## 9.2.9 The operation setting



Configuration operation Settings:

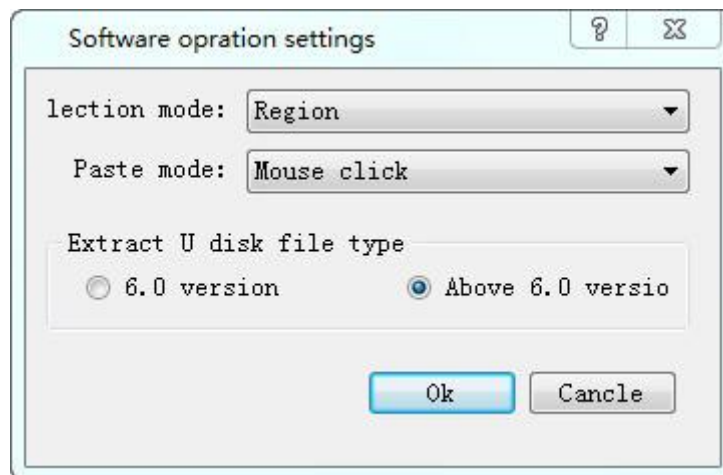

- choice model
  - regional choice: when the mouse choose regional section contains selected area can be selected to the control
  - controls selection: when the mouse choose region completely completely contains selected control can be selected to the control
- paste mode
  - mouse click paste: copy control, click paste the user to choose paste placed control
  - same position paste: copy control, click paste, paste controls in place to be copied



- 
- controls peripheral location
  - extract U disk file type
    - 6.Version 0: generate version 6.0 U disk file
    - is higher than version 6.0: generate higher than version 6.0 U disk file

## 9.2.10 Text Library

### Text library

The text library control is used to set up a common text library for users to reduce the user's repeatable text data input.

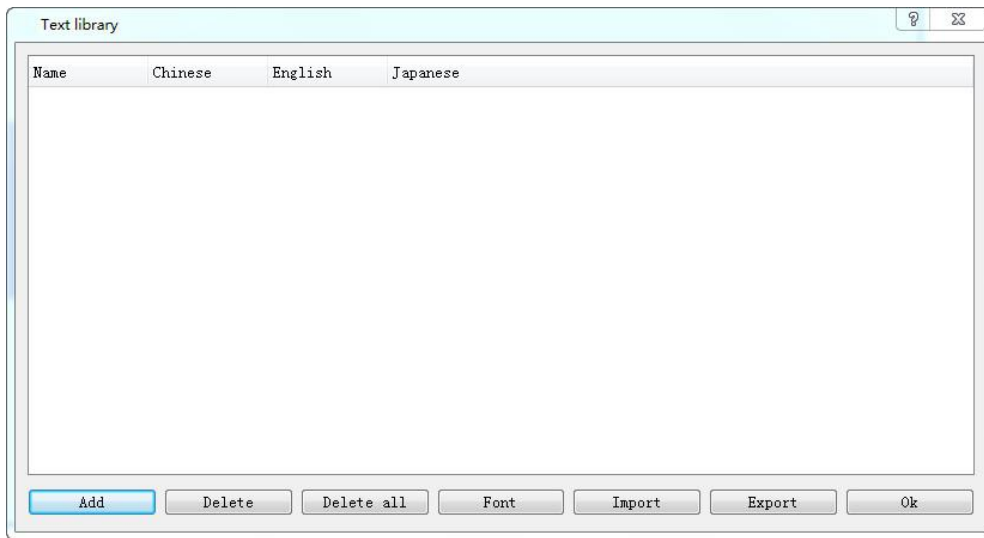

This is a simple introduction to the control usage method.

#### 1. Building text library data



Set up the data of the text library control and set the number of states

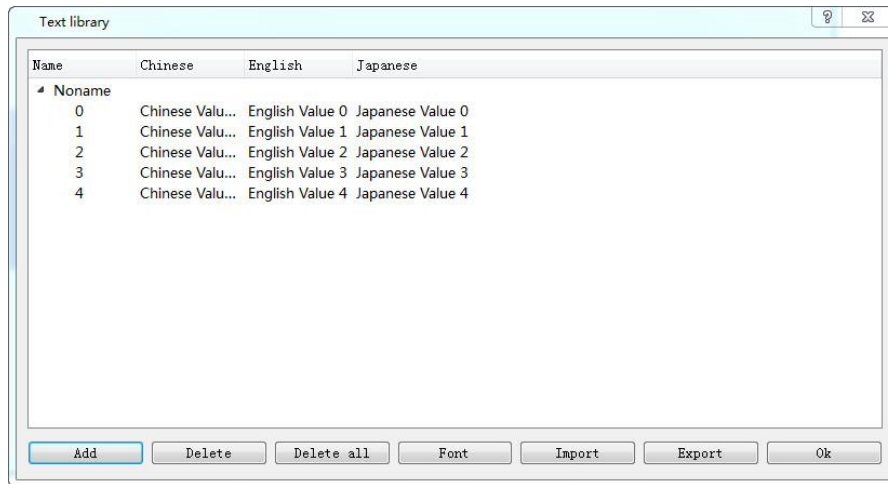

Double-click the corresponding input area in the corresponding language to complete the data input

2. Use the text library in the control

Take a switch example, check the text library, and choose the corresponding text after selecting the corresponding language

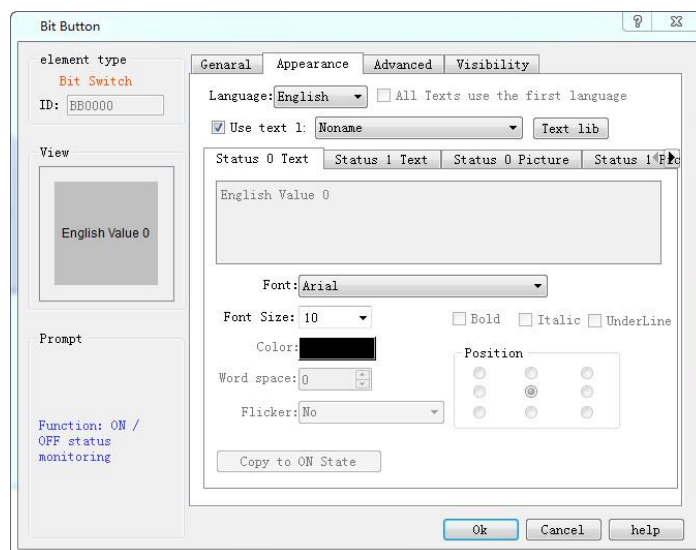
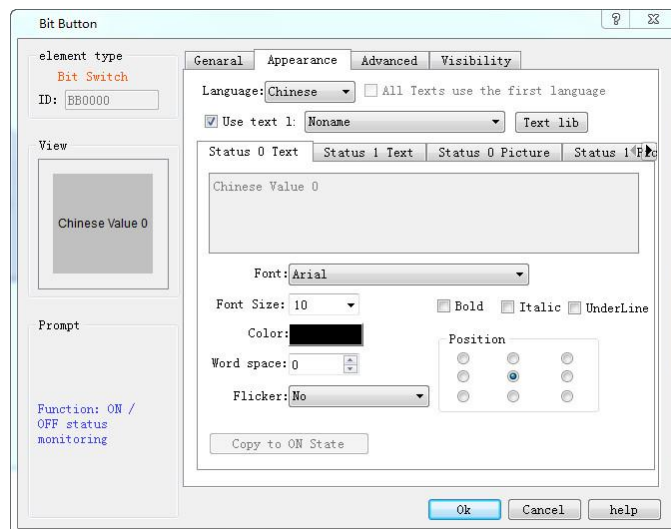

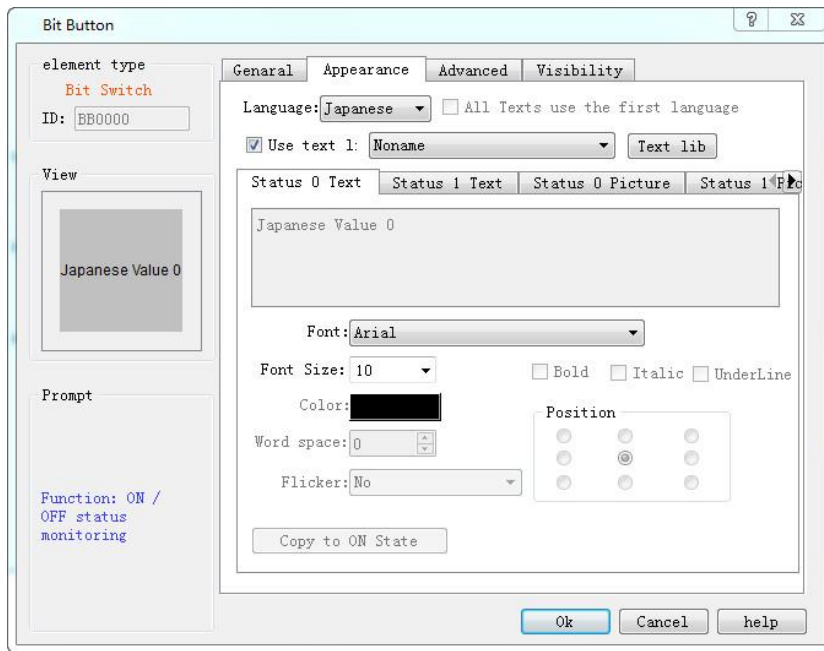

2. Set different data for using the same variable in the text library

When the control of the text library has a variety of states, it can be automatically switched to the corresponding text library data depending on the state of the state, or the switch to the position switch, when the text library data is automatically switched to state 1

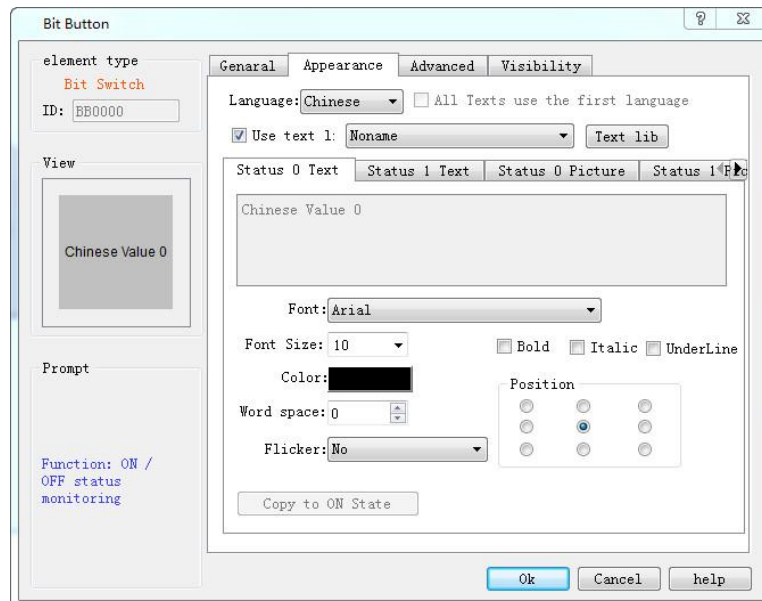

state 0:

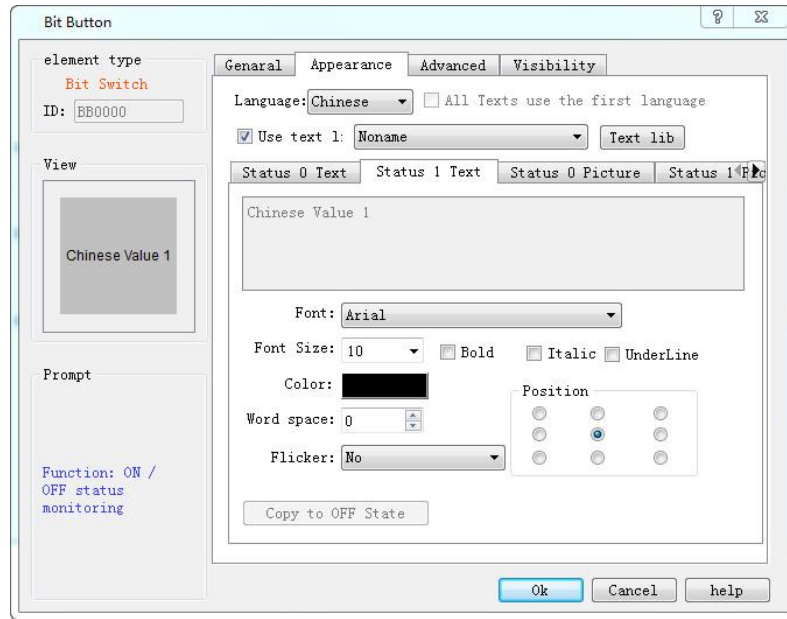

state 1:

## 9.2.11 Address Library

# Address library

The address library control, the user is an alias for the register, and the user can access the variable that needs to be read in two ways of using the address tag and the register address.

The use of the address library is described below

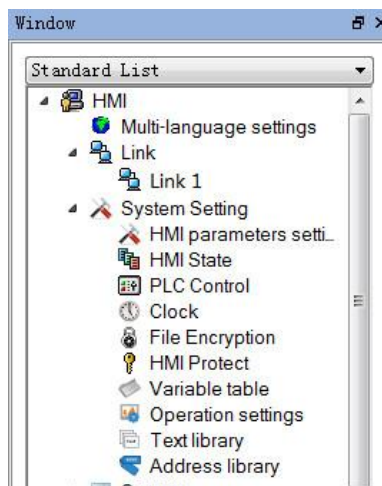

Set the address library tag

Double-click the "address library" option to pop up the following dialog

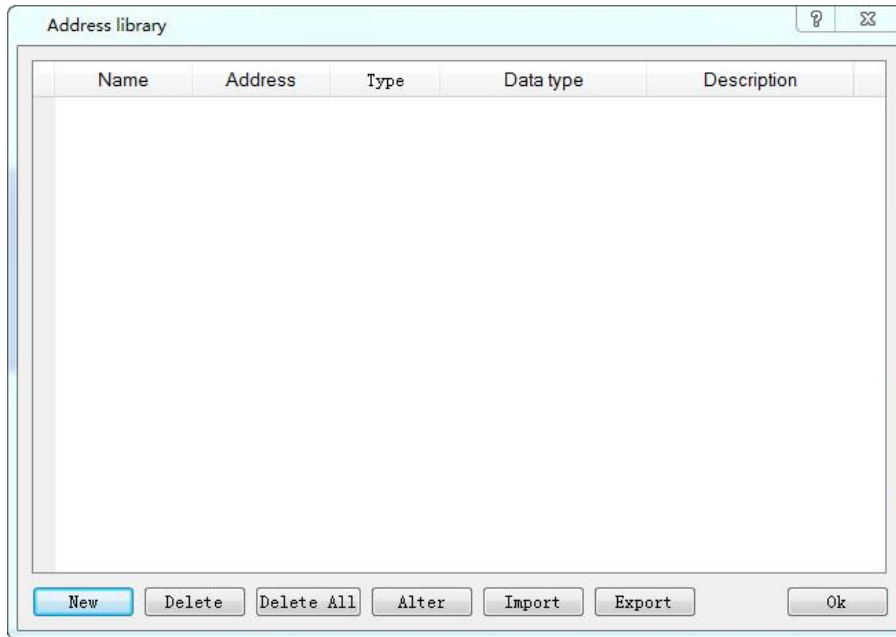

Click the new button to pop up the following dialog

Description: Add the description information to the current added address library tag to facilitate users to view the current variable information and USES

Command: the custom address tag is the equivalent of setting an alias for the register, which can be used in the direct space to select the variable alias to achieve the use of the register

Address type: set the data type of the variable alias, and there are only two options

Address: set the register address associated with the address tag

Address number: users can add address tags in bulk, and the current address tag function only supports the operation of a single variable, without an array of address tags

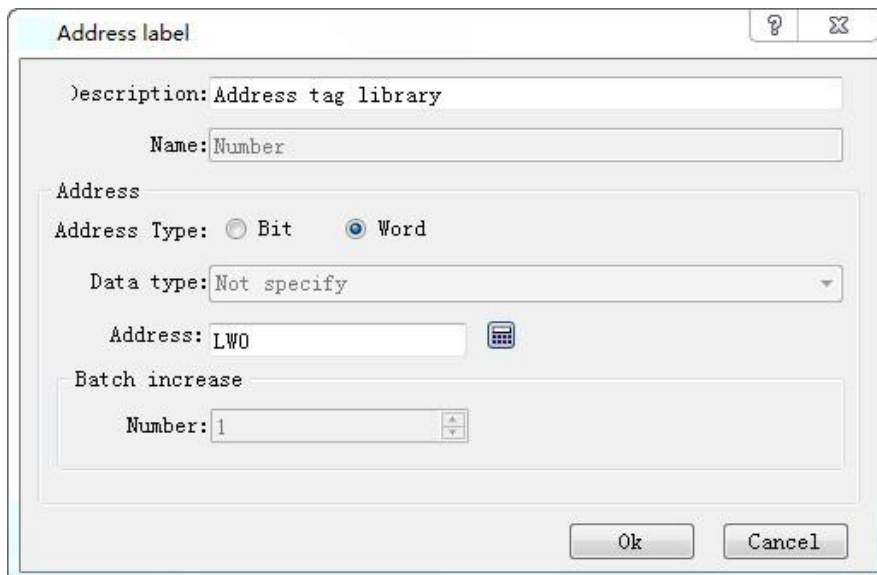

Set up a lw0 address tag number in the figure below, and the following diagram is shown as shown in the following diagram

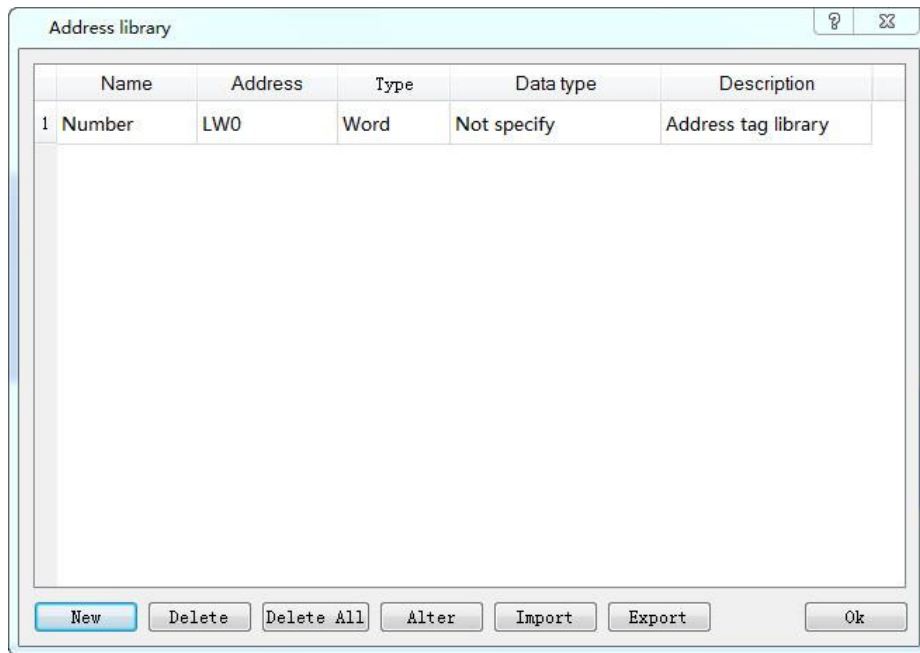

Use the address library tag

The lw0 address tag, defined in the figure above, is used as an example to describe the usage of the address

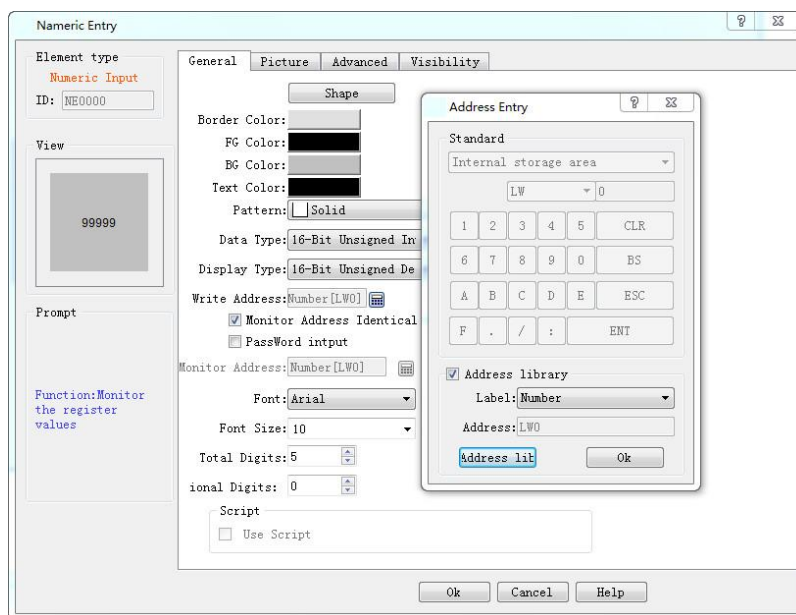

Select the select address input control, select the address tag library, select the label that you need to use, and see the address in the address of the site label in the address, click the address library, and the user can view all the address tags that the current user defines.

The following diagram is shown following the completion

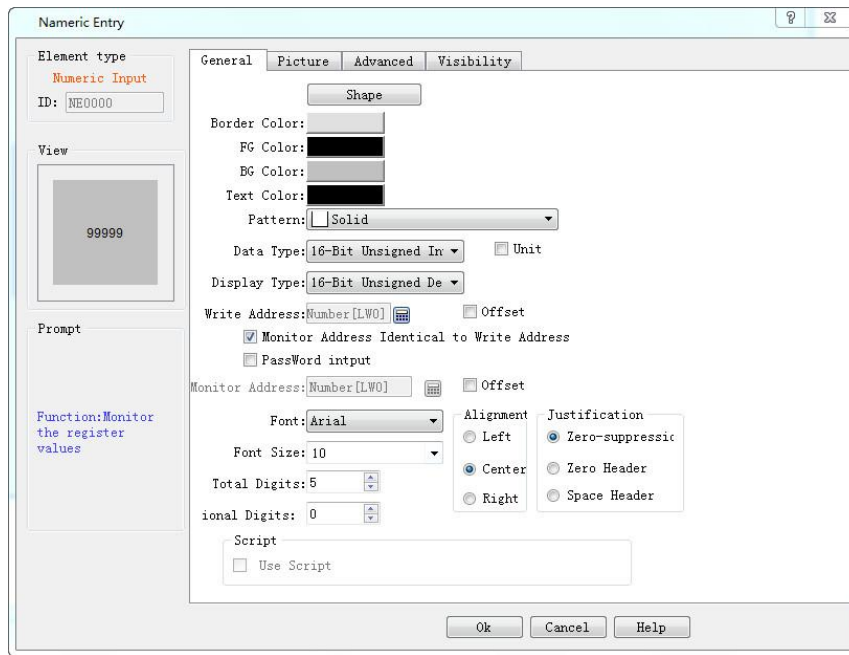

In the image, a numeric input control is placed, the address lw0, as shown below



Download to the touch screen or use in the online analog function monitor operation effect, this is an example of the online simulation, and the input data 40, lw0 registers in the number changes, and the input in the lw0 is also changed





Address tag function, convenient for users to define a special address label for the commonly used register, use the change address label in the configuration program, reduce the user's cumbersome address input, and make it easier and faster to complete the writing operation of the configuration

### 9.3 Screen



Create a new screen as shown in Figure 7-17:

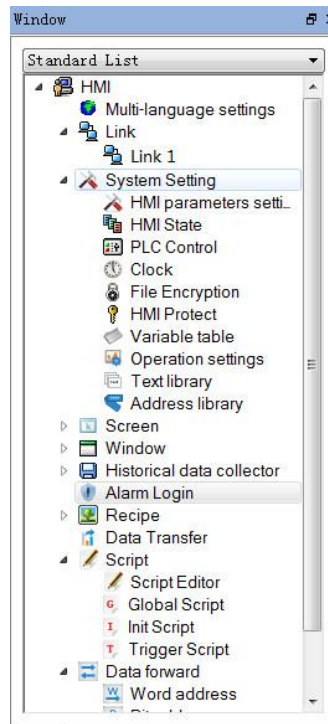

Figure 7-17 Right-click screen options



- Right click the "Screen" in the Project Manager, and then select "Add Screen" to create a new one. In the pop-up dialog box, set the properties such as "Screen Name"; click "OK".
- Two ways to open other screens: double click the screen name in the "Project Manager"; right click the screen name and select "Open" in the pop-up menu.
- Delete: Delete the screen by right clicking the screen name and selecting "Delete" in the pop-up menu.
- Property: Right click the screen name, and select "Property" in the pop-up menu; or, the select "Screen Properties" in the menu bar.
- Copy: Right click the screen name, and select "Copy" in the pop-up menu to copy; set the new screen name and click OK to complete.

## 9.4 Window



Way to add a new window is similar to that to create a new screen. Refer to screen operations for the open, delete, copy or properties of window. The Properties dialog box of the window is shown in Figure 7-18.

Open a window in screen, and a window will display in the screen.

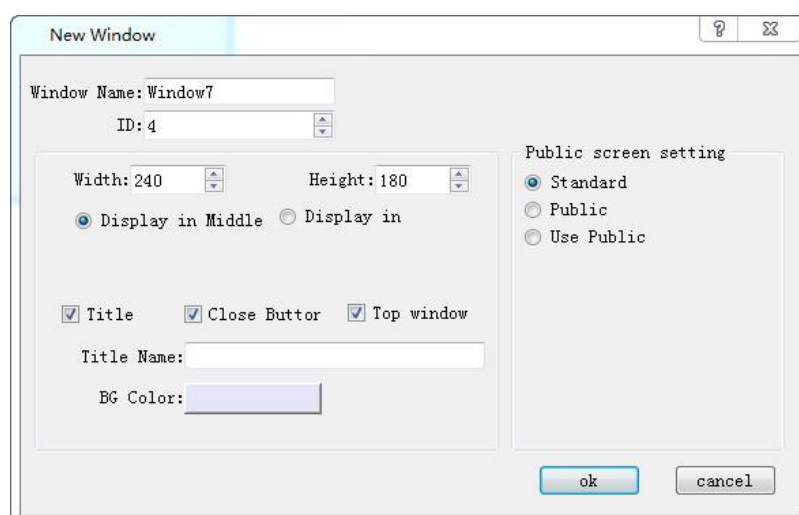

Figure 7-18 Window Properties dialog box

- 
- Height, Width: Set the height and width of the window respectively.
  - Display in Middle: When the window pops up, it is displayed in the center of the HMI.
  - Display in: Set the X-coordinate and Y-coordinate point on which to display the window. The origin of coordinates is the top left corner of the HMI screen.
  - Title: Enter the title name that will pop up as a title bar with the window.
  - Close Button: Whether the window has a close button.
  - Top window: Whether lock other screen and window when this window opening.
  - Background Color: Set the background color of the window.
  - Standard: Not as a public window, and not use public window.
  - Public: show the window's all objects on the windows that select "use public".
  - Use Public: The window can show the "Public" window's all objects and controls.

## 9.5 Historical Data Collector

---

The Historical Data Collector functions in conjunction with the [Historical Data Display](#) on the toolbar. The former is mainly applied for parameter settings while the later is mainly to display the historical data.

Create a historical data collector by right clicking "Historical Data Collector" and select "New Historical Data Collector" in the pop-up menu.

Note: SKTOOL newly supports multiple sets of historical data; up to four historical data collectors can be built.

Note that you cannot create more than four sets; otherwise an error dialog box will pop up as follows:

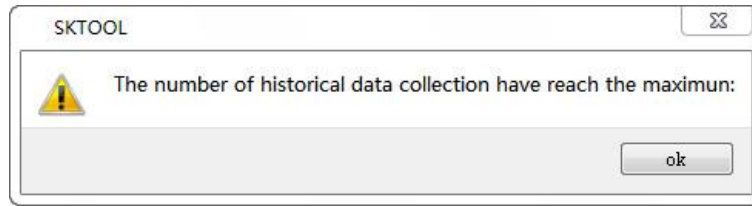

Double click "Historical Data Collector 0" in "Project Manager" to open a dialog box as shown in Figure 7-19:

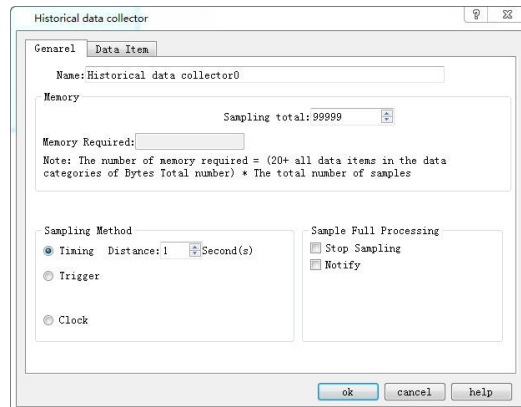

Figure 7-19 Historical Data Collector dialog box

- Name: Set the name displayed in the Project Manager.
- Sampling length: Number of data to be read each time from the memory.
- Total number of samples: Times of extracting data.



Note: The memory required = (20 + total bytes of data types occupied by all data items) \* total number of samples.

"20" refers to the bytes occupied by time and date;

"Total bytes of data types occupied by all data items" refers to the sum of the data types selected for each item on the Data Items page.

For example, as shown in Figure 7-20:

---

a, if the data type of each item is "16-bit positive integer", then "total bytes of data types occupied by all data items" =  $2 + 2 + 2 + 2 + 2$ ; that "all data items  $(20 + 10) * 2$ , which is equal to 60; the bytes number of "16-bit data" is 2 while "32-bit data occupies 4 bytes.

b. If the data type selected for "LH1" and "LH3" is "32-bit positive integer" (when the data type selected for "LH1" and "LH3" is "32-bit positive integer", the address of the "Data item" displays as LH0, LH1, LH3, LH5, LH6), then "the total number of bytes occupied by all data items" =  $2 + 4 + 4 + 2 + 2 = 14$ ; then the required memory =  $(20 + 14) * 2 = 68$ .

Read Address: Start address to read data (Refer to Data Item for detailed information)

Sampling method:

- Timing: Read data at set interval.
- Trigger: Read data when the value of the trigger address is 1.
- Clock: Start reading data at a user-set time interval.

Full sampling disposal manner: Disposal when the data sampling reaches the maximum total number.

Stop sampling: Stop data sampling in case of full sampling; if this option is not selected, the new read data will replace the oldest one.

Notify: Inform an address whose value is 1 when the sampling number reaches the maximum.

Click the "Data Item" tab, set the page properties, as shown in Figure 7-20:

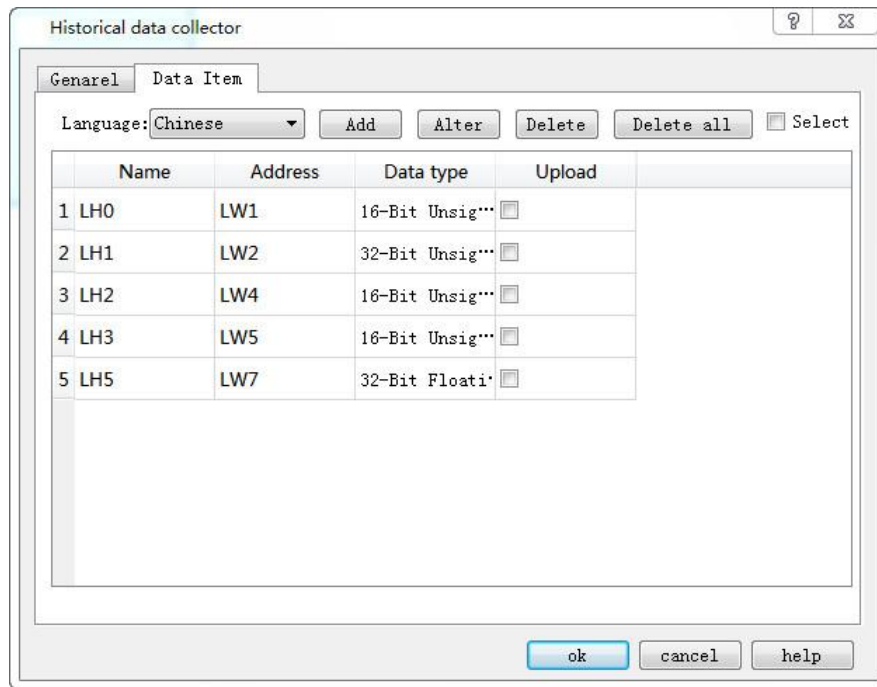

Figure 7-20 Data Item of Historical Data Collector

If multi-language is selected, it is necessary to set names for each language when adding new data items; otherwise it cannot add new items.

In SKTOOL, the address of each group of historical data can be set discrete, according to the actual situation of LW register, for example: S1 is LW1, S2 is LW89, S3 is LW8905.

Click on any item in the list box to set the properties.

An example in detail:

Set the read address to LW1 on the General page, the register address is set consecutively and the sampling length is 5; click the Data Item tab and add 5 columns of data (LH0-LH4) in the list. Select each to set the properties such as name, address, data type, total digits decimal places and whether to scale.

Assuming that the names, data type and scaling of LH0-LH4 are set as shown in Figure 7-20; other attributes are default values:

LH0-16 bit Positive integer, Scaling, with a gain of 3 and an offset of 2

---

LH1-32 bit positive integer, Scaling, with a gain of 2 and an offset of 1

LH2-16-bit integer, Scaling is not selected

LH3-32-bit integers, Scaling is not selected

LH4-Floating point, Scaling, with a gain of 4 and an offset of 5

After the settings, since the sample length is 5 (set in General page), it reads out 5 address values consecutively starting with "Read Address". Addresses are read according to the data type of each item.

If select 16-bit data, the extracted address is continuous. If 32-bit data is selected, the fetched addresses are separated. If the scaling function is selected, the final read value is equal to the value of read address multiplied by the gain plus the offset.



Set up each data type and whether to scale; the addresses to be read are as follows:

LH0-LW1 (16-bit data, read address + 1) Final value of LH0 = Address value of LW1  $\times$  3 + 2

LH1-LW2 (32-bit data, read address +2) Final value of LH1 = Address value of LW2  $\times$  2 + 1

LH2-LW4 (16-bit data, read address +1) Final value of LH2 = Address value of LW4

LH3-LW5 (32-bit data, read address +2) Final value of LH3 = Address value of LW5

LH4-LW7 (32-bit data, read address +2) Final value of LH4 = Address value of LW7  $\times$  4 + 5

After settings, click "OK". Click "Historical data display" icon on the toolbar; set the row number to 5 in the pop-up dialog box, the other attribute values are by default.

Click "OK" to generate a table automatically in the screen, as shown in Figure 7-21:

| Time | Date | LH0 | LH1 | LH2 | LH3 | LH4 |
|------|------|-----|-----|-----|-----|-----|
|      |      |     |     |     |     |     |
|      |      |     |     |     |     |     |
|      |      |     |     |     |     |     |
|      |      |     |     |     |     |     |

Figure 7-21 Data Table of Historical Data Display

Application of the above table:

- Date: The date on which the address value is read
- Time: The time when to read the address value
- "LH0": Display the value of the LW1 at a certain time.
- "LH1": Display the value of the LW2 at a certain time.
- "LH2": Display the value of the LW4 at a certain time.
- "LH3": Display the value of the LW5 address at a certain time.
- "LH4": Display the value of the LW7 address at a certain time.

For example, the read address is LW1, the user-defined data sampling length is 3, the total number of samples is 10, the sampling method is Trigger, the time interval is 1 second, and the data type of each data is the default;

1). The option of Stop Sampling is not selected:

The LW1, LW2, LW3 address values are read every 1 second. Since the total number of samples is 10, 10 sets of data are read out at the tenth second. Because the "Stop sampling" option is not selected, the process continues. A fixed memory area depending on the sampling length, total number of samplings and data type is allocated to store the read data, so when the number of data groups has reached the "total number of samplings," the latest read data will replace the first one.

2). The option of Stop Sampling option is selected:

The only difference is that it stops sampling when achieve the total number of samplings.



---

Employ “[Historical Trends](#)” or “[Historical Data Display](#)” to read the values more intuitively.

## 9.6 Alarm settings

---

SKTOOL alarm settings consist of digital alarm login and analog alarm login. Users can view the alarm type and the occurrence time through Alarm control or Alarm Bar after setting up the alarm login.

### Contents:

- [Digital Alarm Login](#)
- [Analog Alarm Login](#)
- [Alarm Display Controls](#)
- [Discrete alarm login](#)

### 9.6.1 Digital Alarm Login



Alarm Setting is employed to display alarm information, only with which the alarm control and alarm bar run normally (in fact, the alarm control and alarm bar displays the alarm message of "digital alarm login" and "analog alarm login").

Right click the "Alarm landing" in the Project Manager and select "New digital alarm", as shown in Figure 7-22:



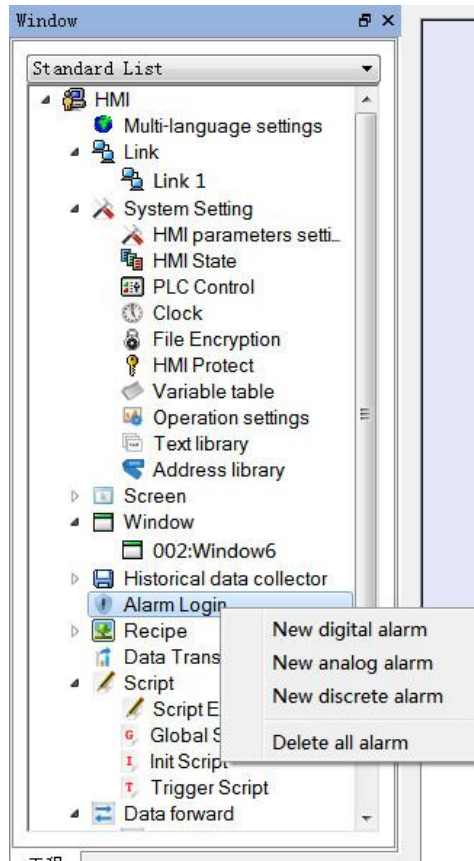

Figure 7-22 Select alarm log

Double click the "digital alarm login" option to open the digital alarm settings dialog box, as shown in Figure 7-23:

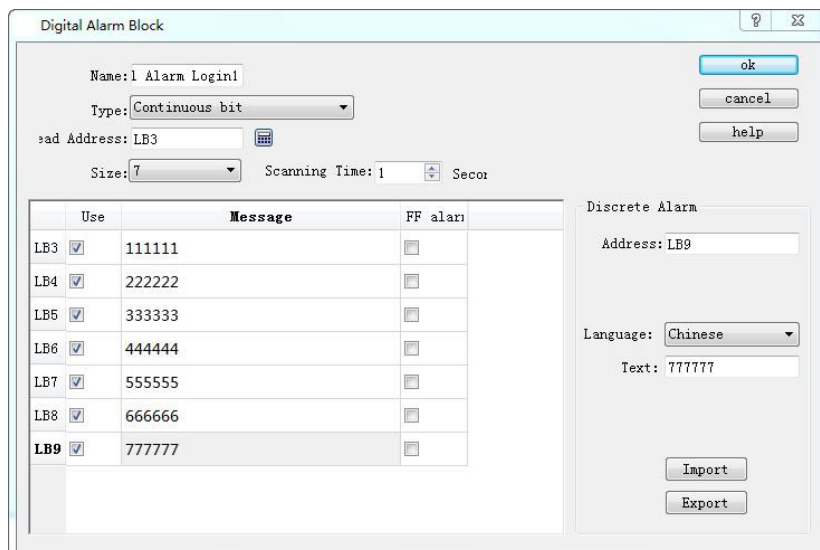

Figure 7-23 Select continuous digit

---

Steps to build a digital alarm log are as follows:

- Enter the read address first; it is assumed here that the internal address LB1 is set.
- In the "Size" column, select the total number of alarms, i.e. the total number of bit addresses, which is continuous. It is assumed here that the set value is six.
- Set the bit alarm "Scanning time", that is, the scanning frequency.
- Click an item in the list box, and then move the mouse to the right of the "Message" module; input text information in the "Text" edit box serving as the alarm content. Here assume that the alarm messages are as shown in Figure 7-23.
- If "Use" is selected, the alarm information will be displayed in "Alarm Control" or "Alarm Bar". Otherwise the alarm message will not appear even if the corresponding address is 1. If the address value of this item is 0, the alarm information does not show.
- OFF Alarm: When this option is selected, the alarm will be generated when the corresponding address value is 0 (OFF value). Otherwise, an alarm will be generated when the address value is 1 (ON value). By default, an alarm occurs when the address value is 1 (ON).
- U export: export alarm settings information
- U import: import alarm settings information

Here is an example: Suppose the choice of type is "Continuous bit".

- If the value of LB1 address is 0, the alarm information will not be displayed in "Alarm Control" and "Alarm Bar", regardless of whether the "Use" option is selected or not.
- If the value of the LB1 address is 1 and the "Use" option is not selected, the alarm information is not displayed in the "Alarm Control" and "Alarm Bar".
- If the value of LB1 is 1 and the "Use" option is selected, the alarm information will be displayed in "Alarm Control" and "Alarm Bar".

Click "OK" to complete digital alarm settings. Users can add 6 bit buttons with the function of Alternation whose address is LB1-LB6; place controls of "Alarm" and "Alarm Bar" on the screen; then execute offline simulation to check whether it displays alarm information.

The following is an example of offline simulation as shown in Figure 7-24:

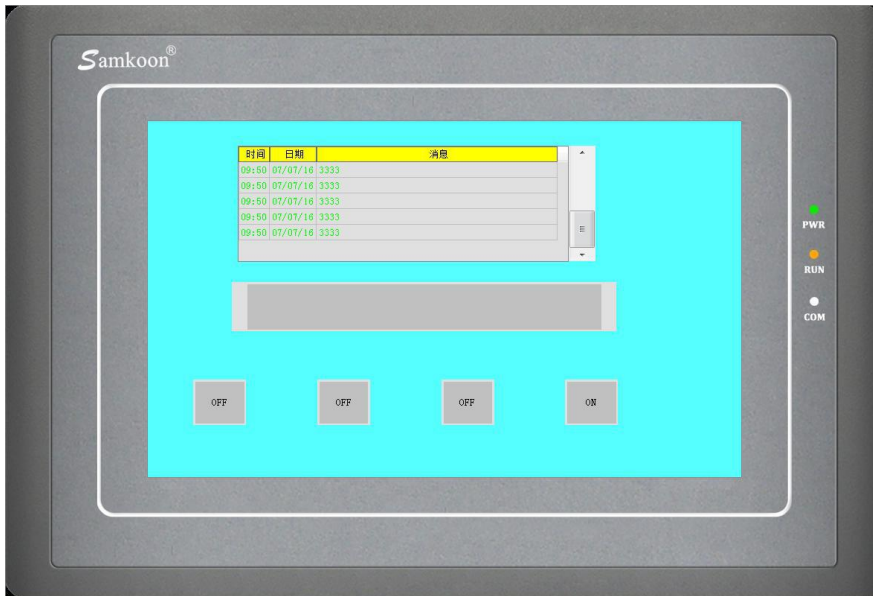

Figure 7-24 Offline simulation example of digit alarm

When "Continuous Bit of Word" is selected as the Type, as shown in Figure 7-25 below:

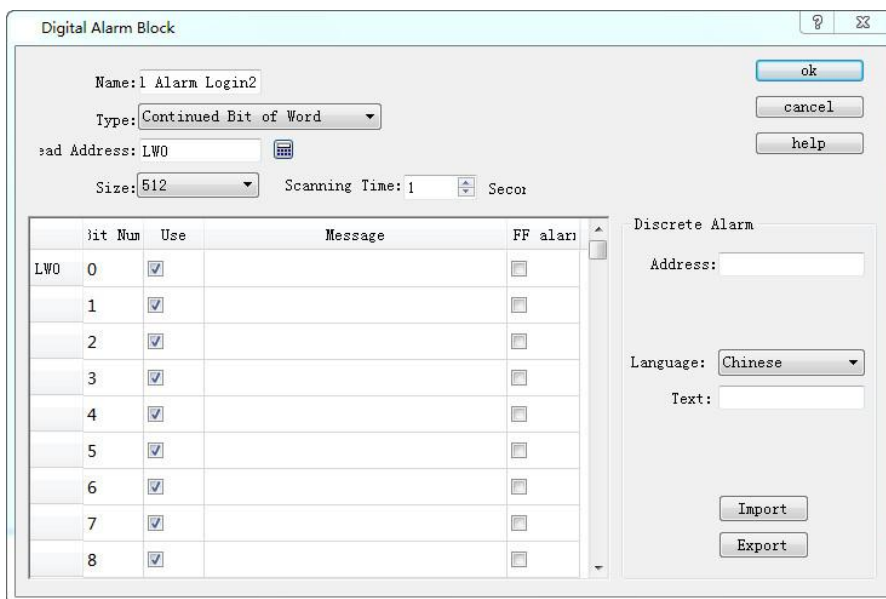

Figure 7-25 Select Continuous Bit of Word

If the "Use" of a certain bit number is selected, an alarm will be generated when the value of this bit value is 1.



---

Note: When copying the contents of alarm messages from other documents to the alarm text of digital alarm log and analog alarm log, please make sure that there is no line break (invisible) in the message. It is recommended to input the message manually rather than copy and paste, in case of display error of alarm message.

If "Word value" is selected for the type, as shown in Figure 7-26 below:

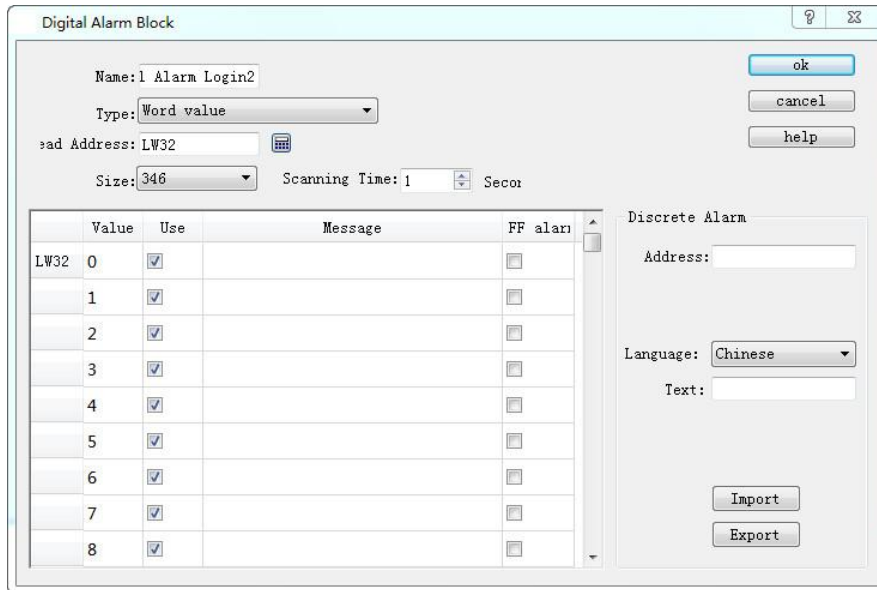

Figure 7-26 The "Word Value" digital alarm dialog box

When a value of the address is selected, the alarm is generated when the value of the address is equal to the value selected in the list.

Place an Alarm control with 7 lines as the example in Figure 7-24 and a Dynamic alarm bar whose attributes are set as shown in Figure 7- 27:

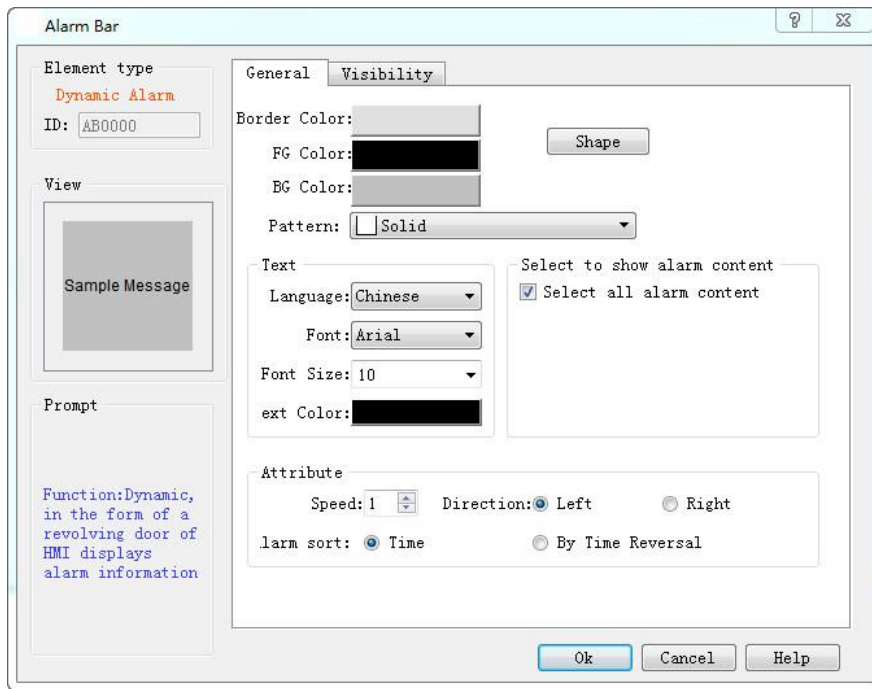

Figure 7-27 Dynamic Alarm Bar Properties dialog box

Add lastly six bit buttons whose write address is LB1-LB6 with the "Alternation", "Monitor" and "Monitor Address identical to Write Address" functions set for each. After the settings, click the "Save" button on the toolbar to save the project, execute the "Offline" command in the "Download" item in the menu bar, and then click the bit buttons LB1, LB2, LB4 and LB6. In this case, the Alarm control and Dynamic Alarm Bar will display the alarm information of LB1, LB2, LB4, and LB6 in the "Digital Alarm" When click them again, "Alarm Control" and "Dynamic Alarm Bar" will display nothing since their values are 0 because of the alternation function.



Note: Different alarm information is available for corresponding language through the function of switching language.

Note: Number of digital alarm is up to 10 for SK series HMI.

---

## 9.6.2 Analog Alarm Login

---

Open the analog alarm settings dialog box, as shown in Figure 7-28:

It has two types: Numerical value and Numerical comparison.

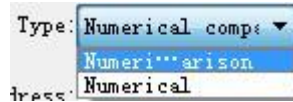

The numerical comparison alarm is as shown below:

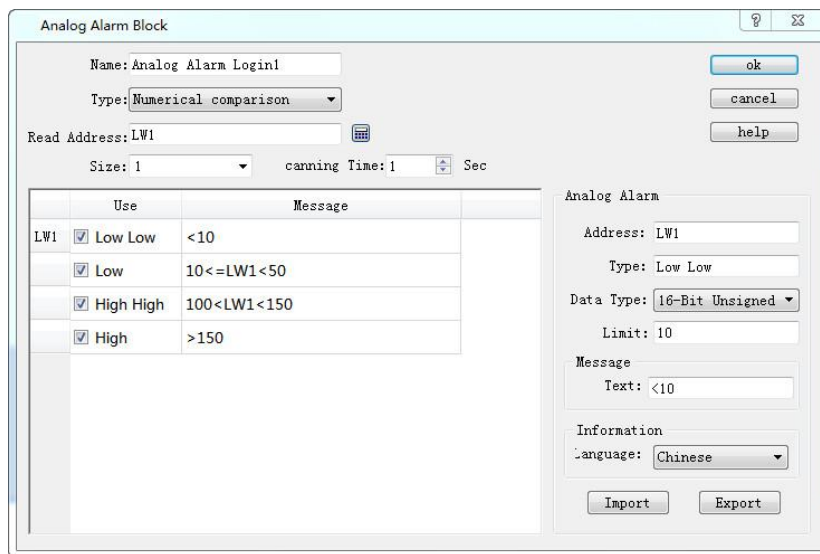

Figure 7-28 Analog Alarm Login dialog box

If user needs to use the analog alarm, steps are as follows:

- First input the address in the "Read Address" column to alarm. It is assumed here that the internal address LW1 is set.
- Select the total number of alarms in the "Size" option, which means the total number of addresses; data type decides the way to read address. Each address value is set firstly as the 16-bit data type and it is continuous. But the data type can be changed. As shown in Figure 7-28, the LW1 address chooses a 32-bit positive integer while LW3 and LW4 values are 16-bit positive integers. Therefore, when 32-bit data is selected for an address, the later address value to be read is added by 2 on the basis of the former address value; and if the 16-bit data type is selected, the later address value to be read is the former value plus 1.
- Users can set the "Scanning time" of the alarm, which means the scanning frequency.
- Click each item to input a value in the "Limit" box on the right; then enter the text information (alarm content) in the "Text" box. Here assume that the message is as shown in Figure 7-28: each address value can be classified into one of four ranges-- Low, Low Low, High, High High.

As shown in Figure 7-29:

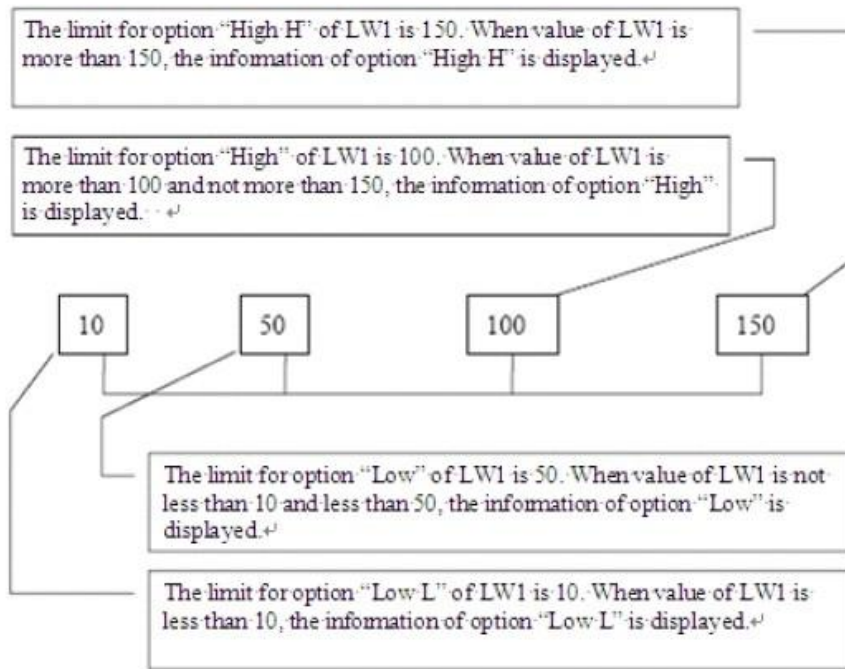

Figure 7-29 Diagram of the four address values for the LW1 address

- Low Low: When the value of this item is less than the limit of this setting and the "Use" option is selected, the alarm information of this item will be displayed in "Alarm Control" or "Dynamic Alarm Bar";
- Low: When the value of this item is no less than the "Low Low" limit while less than the "Low" limit and the "Use" option is selected, the alarm information of this item will be displayed in "Alarm Control" or "Dynamic Alarm Bar";
- High: When the value of this item is greater than the "High" limit while no greater than the "High High" limit and the "Use" option is selected, the alarm information of this item will be displayed in "Alarm Control" or "Dynamic Alarm Bar".
- High High: When the value of this item is greater than the limit of this setting and the "Use" option is selected, the alarm information of this item is displayed in "Alarm Control" or "Dynamic Alarm Bar".
- U export: export alarm settings information
- U import: import alarm settings information

Refer to "Digital Alarm Login" for the application of "Use".

Numerical value alarm means an alarm occurs when the value reaches the set limit value.

The settings are as follows: Alarm is triggered when the alarm value reaches 1, 12, 30 and 40.

Analog Alarm Block

Name: Analog Alarm Login2

Type: Numerical

Read Address: LW1

Size: 1      Warning Time: 1 Sec

|     | Use   | Message |
|-----|---|---------|
| LW1 | <input checked="" type="checkbox"/> Value 1 | 1       |
|     | <input checked="" type="checkbox"/> Value 2 | 12      |
|     | <input checked="" type="checkbox"/> Value 3 | 30      |
|     | <input checked="" type="checkbox"/> Value 4 | 40      |

Analog Alarm

Address: LW1

Type: Value 1

Data Type: 16-Bit Unsigned

Limit: 1

Message

Text: 1

Information

Language: Chinese

Import      Export



Note: Number of analog alarm is up to 10 for SK series HMI.

### 9.6.3 Discrete alarm login



In the expansion of the alarm login options, double-click the "new discrete alarm login" option, you can open the discrete alarm settings dialog box

Alarm Login

Name:      Language: Chinese

New      Delete      Delete All

| Address | Alarm Condition | Message | Color | Wploa |
|---------|-----------------|---------|-------|-------|
|         |                 |         |       |       |

Import      Export      Warning Time: 1       Select all      Ok      Cancel      Help

New: a new alarm content, data categories can be freely selected



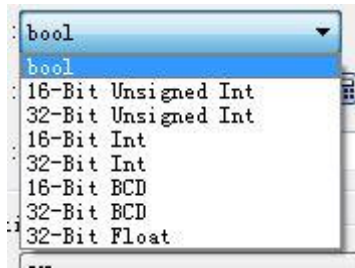

Delete: delete an alarm content

Delete all: delete all alerts

Export: set up a good alarm content

Import: import and set up the alarm content

New alarm setting screen:

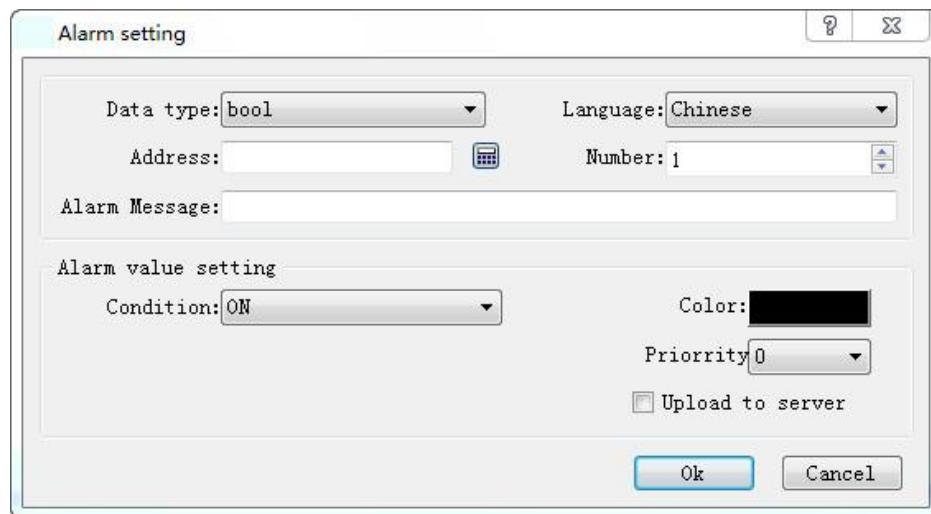

Data categories: according to the need to choose the appropriate data categories to determine the alarm conditions

Address: set the address that needs to be monitored and alarm

The number of consecutive: according to the need to set whether the need for continuous N address monitoring

Alarm information: the alarm information displayed when the address value is set to alarm condition

Alarm condition: set the alarm condition of the address value, and the alarm condition is shown below:

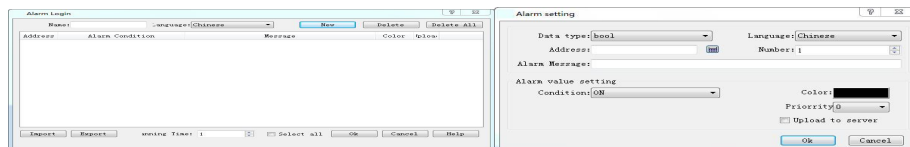

L bit ON alarm: when the data category is bool, the address is ON trigger alarm

L bit OFF alarm: when the data category is bool, the address is OFF trigger alarm

L fixed value alarm: when the address value is set value, the alarm is triggered

L range alarm: when the address value is within the set range to trigger alarm

L out of range alarm: when the address value is not within the set range, the alarm is triggered

Alarm color: set the address value to trigger the alarm is the color of the alarm information

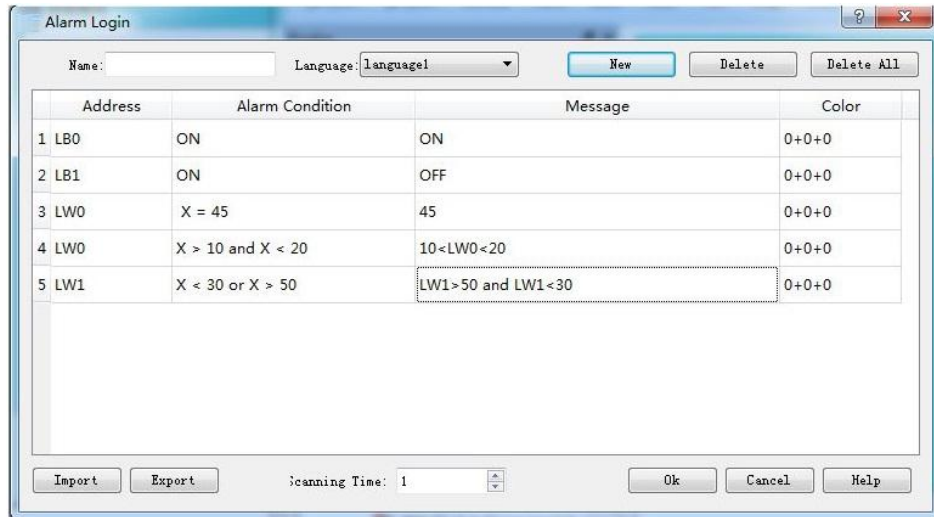

Analog alarm number: at present, SK series HMI can only set up 2 analog alarm

## 9.6.4 Alarm Display Controls



It can add alarm display control after the settings: Alarm Display, Alarm Bar and Historical Alarm Display.

Select  in the toolbar menu to set the alarm bar display parameters in the dialog box, as shown in Figure 7-30:

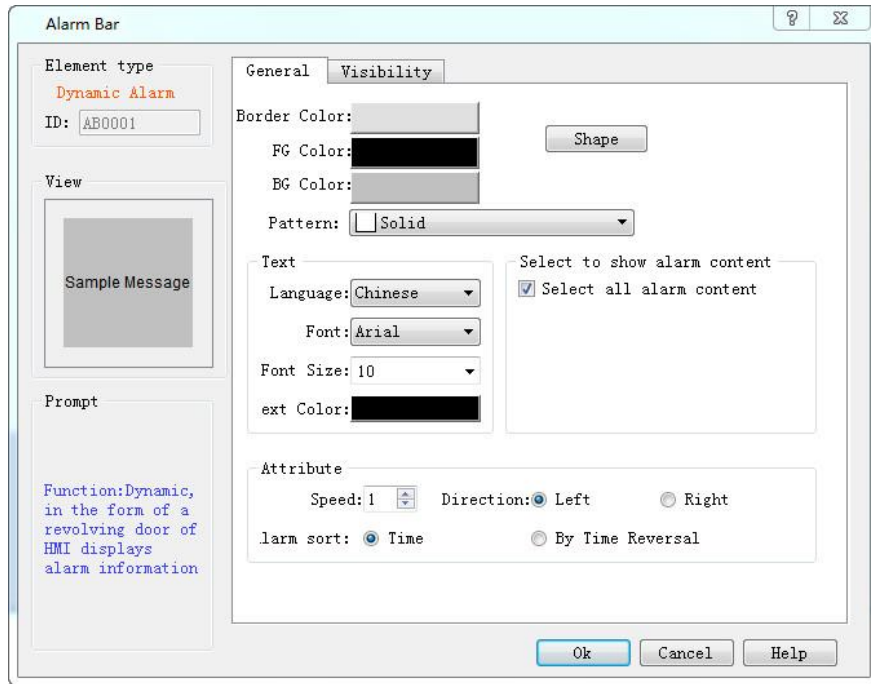

Figure 7-30 Alarm Bar dialog box

- Speed: the movement speed of the alarm information;
- Direction: The alarm bar moves from right to left or left to right;
- Alarm sort: The display order of alarms by chronological order or by traverse chronological order.

Select the alarm control in the toolbar menu to set the alarm display text and parameters in the dialog box, as shown in Figure 7-31:

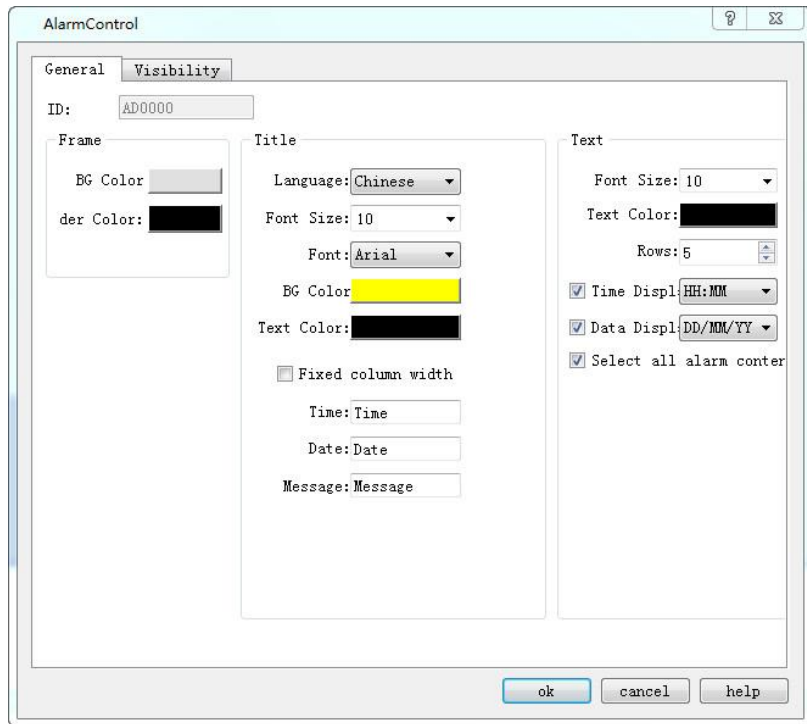
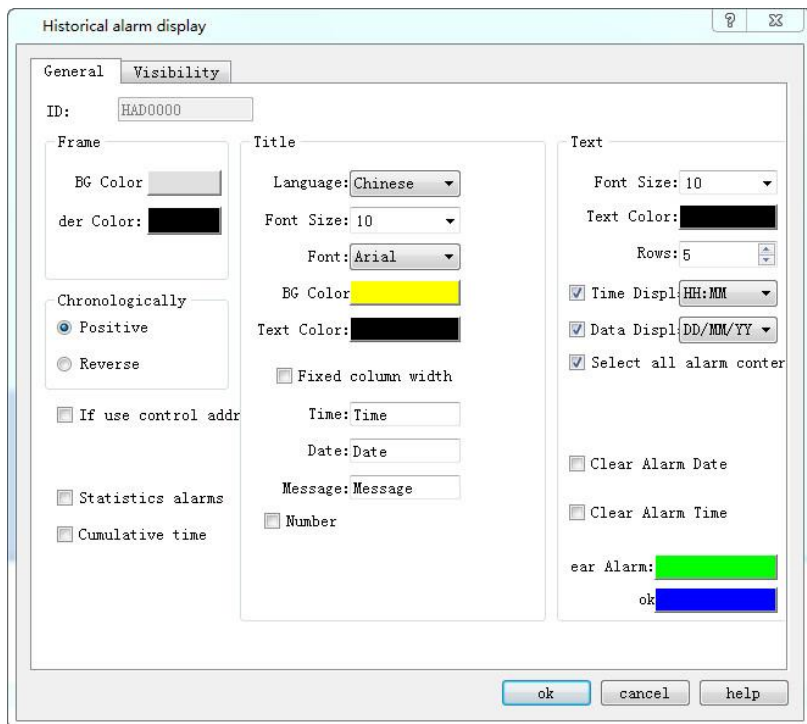

Figure 7-31 Alarm Display dialog box

Select the historical alarm display control in the toolbar menu to set the display content and parameters in the dialog box, as shown below:



Historical Alarm Display dialog box

## 9.7 Recipe



In the field of manufacturing, recipe is used to describe the proportions of materials used to produce a product, and is a set of parameter settings of variables used during production. For example, a basic recipe is necessary for bread making, and this recipe may list the weights or proportions of all materials used to make bread, such as water, flour, sugar, egg, oil, and so on. In addition, it may also list some optional materials such as fruit, nut, chocolate, and so on. These optional materials may be added to the basic recipe to make bread of different flavors. Take iron works for another example. A recipe in an iron works may be a set of machine parameters. For batch processing machines, a recipe may be used to describe different steps of the batch processing.

A machine may make both bread and cakes, including bread of different flavors and cakes of various forms. Here, we call the material proportions of bread as a recipe, and call the different material proportions of different flavors of bread as a file. Obviously, recipe records are contained in recipe files.

SKTOOL provides the function of recipe configuration that is available in the Recipe of the menu bar or in the Project Manager, you can enter the recipe configuration dialog box, add a new set of recipe functions. As shown in Figure 7-32:

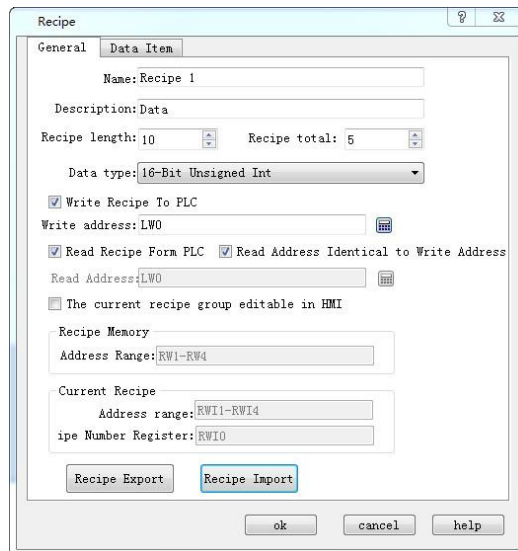

Figure 7-32 Continuous recipe Property Settings Dialog Box

- Name: Name of the current recipe file.
- Description: Description: Name description of the current recipe file;

- Recipe length: Set the length and quantity of the recording address to be read by the current recipe. Addresses of recipe record form are arranged in sequence automatically by the system, and cannot be changed. The maximum length of recipe is 4096.
- Total Number: Number of recipes, up to 512;
- The current recipe group editable in HMI:Enable Edit the recipe in HMI.

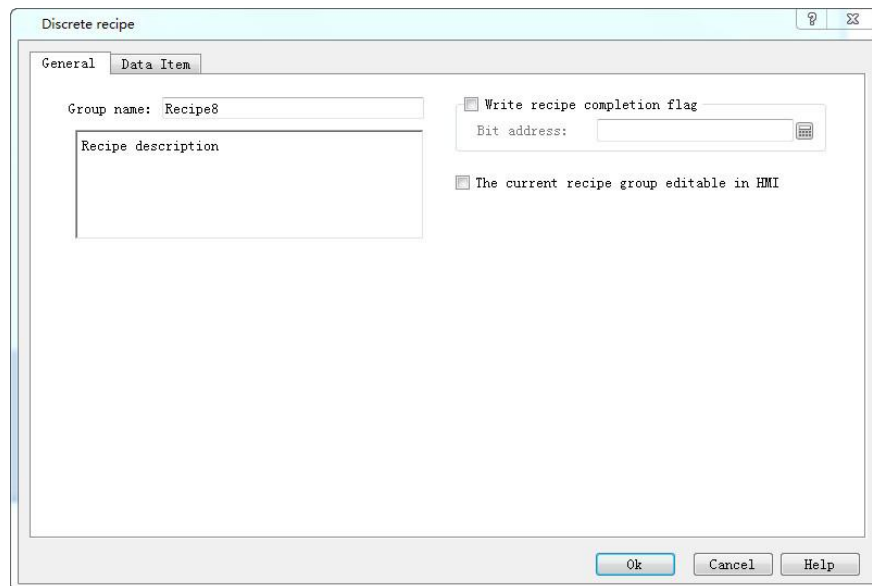

Figure 7-33 Discrete recipe Property Settings Dialog Box

- Group name: Name of the current recipe file.
- Recipe description:Description: Name description of the current recipe file;
- Write recipe completion flag:after current recipe is wrote to PLC,the value of bit address set 1;
- The current recipe group editable in HMI:Enable Edit the recipe in HMI.



Note: Recipe length \* Bytes occupied by data type \* Total number <= 512KB

- Data Type: Data type of the data register;
- Write recipe to PLC: Set related data register address of recipe and PLC;
- Read recipe from PLC: Set related data register address of recipe and PLC;
- Recipe memory: The memory address range of the recipe in the HMI that is automatically generated and cannot be changed;
- Current recipe: The recipe memory address in the HMI and the data register of PLC is automatically generated by order and cannot be changed;

- Recipe Number Register: the recipe is arranged automatically by the order of serial number, and it cannot be changed; it corresponds the order of recipe name in the data item.

The continuous recipe data item, as shown in Figure 7-33:

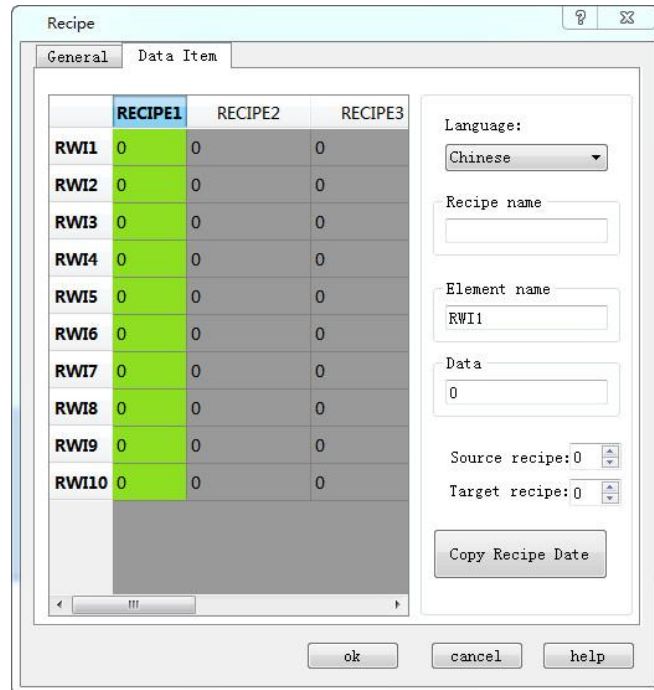

Figure 7-34 Continuous Recipe Data Item Page

- Name: The name of the current recipe;
- Data: Write and display each address value of the current recipe;
- Copy Recipe Data: Copy the data from the source recipe to the destination recipe. Click OK to save the current one and click Cancel to exit the dialog box. Once the recipe configuration has been completed, the interface can be designed to operate the recipe in the HMI.

Application example of Recipe:

1. Create a recipe configuration as described above. The effect is shown in Figure 7-34:

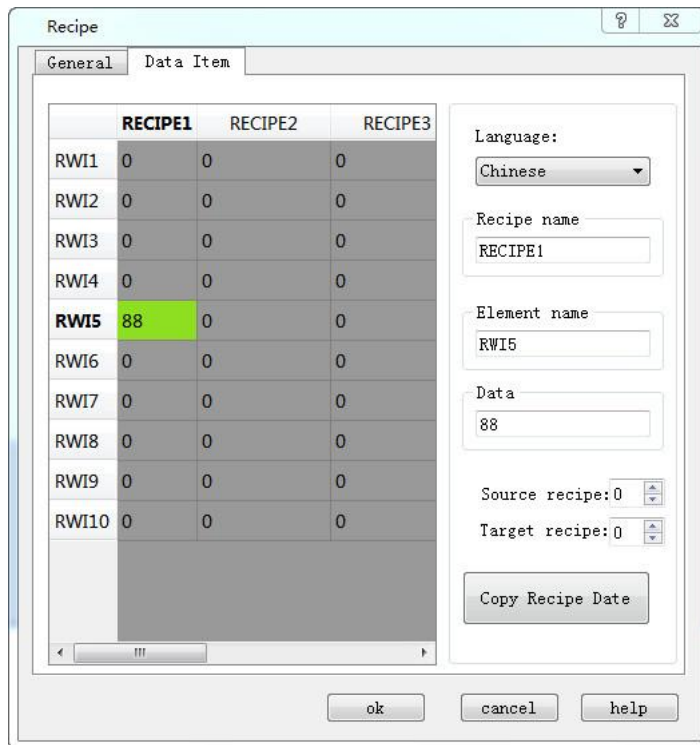



Figure 7-35 Function of continuous recipe data copy

This recipe has a total of 4 sub-recipes, each containing 16 items. The storage addresses are from RWI: 1 to RWI: 16 in the memory of HMI.

2. After the recipe configuration, display the recipe on the screen, modify it or directly download it to the PLC. So we will use the following essential functional controls.

- Recipe display: Click numeric display / input  (refer to "Numerical display / input")  
Select the internal memory address RWI: 0 to create a numerical display and input control on the screen. The input and display value is the recipe serial number. The value 0 of RWI0 means recipe serial number 1; the value 1 means recipe number 2, etc.
- Click the function button : Refer to the "Function button" for operation.

Buttons can be created to write recipe to PLC, read recipe from PLC, save recipe, select the previous recipe and the later one through the function button with relevant function setting.

Application of multiple recipes: SKTOOL provides new function of multi-group recipe, but it supports only ten groups, otherwise a limit message will be prompted as shown in 7-34-2

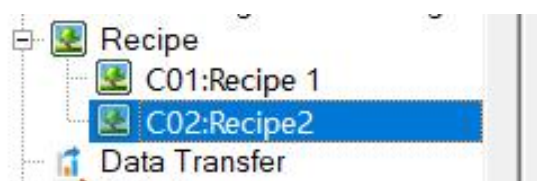



Figure 7-35-1

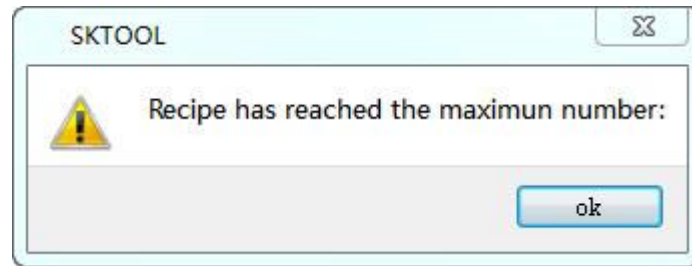

Figure 7-35-2

The LW61141 is employed to enter the recipe group. The original RW10 is also used to input the recipe number. Therefore, it needs to set values of LW61141 and RW10 at the same time when select one. For example: Enter recipe group 0 to LW61141, serial number 2 for RW10; it means selecting the recipe data of Recipe 2 in recipe group 0.

3. According to the above operation, a screen can be created as shown in Figure 7-35:

Assume that all monitor address to be written is D0, the length of the recipe is 16 and the total number is 4.



Figure 7-36 Effect of the Recipe

It is easily available to modify, preserve, read and write recipe through the function buttons and numerical display / input settings. But it should pay attention to the following points:

- Recipe list should be established before use of Recipe functions.
- When writing recipe parameters into the recipe list, pay attention to the data type. 16-bit datum occupies only one word, and 32-bit datum occupies two words. Consistent data type should be chosen. Particularly, pay special attention to use of 32-bit data address. As 32-bit datum occupies two words, prevent address overlapping when entering write-in address and monitored address.

- Address RWIO is for fixed use, and can be used to change recipe number only. If value of RWIO is 0, it indicates the first recipe number, and so on.
- Recipe parameter addresses are continuous.

The discrete recipe data item, as shown in Figure 7-33:

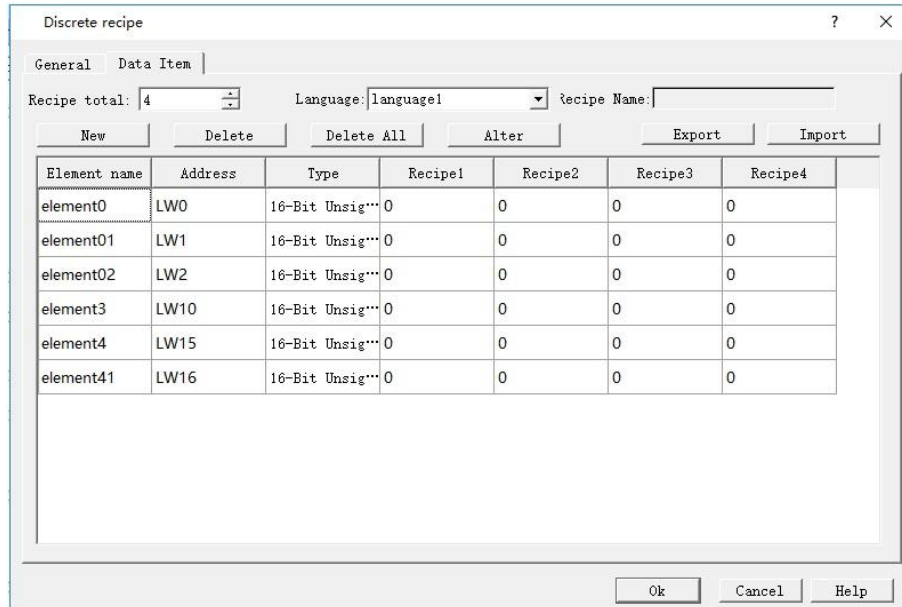

Figure7-41 Discrete recipe data item page

- Recipe total : Number of recipes, up to 128;
- Language: Users can set different languages' Element name and recipe name.
- Recipe name:Modify current recipe name,such as "recipe1","recipe2".
- New:Pop up a "recipe element" dialog,create a element,as shown follow figure.

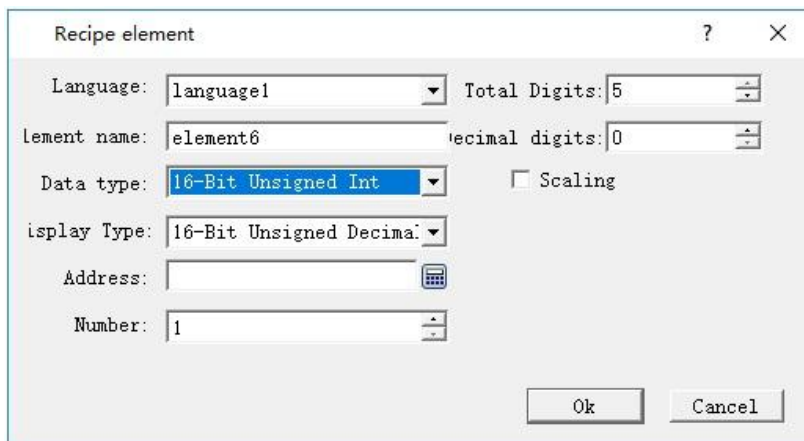

Figure7-42 Discrete recipe new element box

- Delete:delete current recipe element.
- Deleter All:Delete all element in this recipe.
- Alter:Pop up the current element's Recipe element box,modify the information.
- Export:Pop up a save as dialog,save the recipe as a \*.csv file by assign root and name.

- 
- Import::Pop up a open dialog,choose a \*.csv file as current recipe.

## 9.8 Data Transmission

---

Used to transmit data between PLC and HMI or between PLC and PLC. Click "Data Transmission" in the Project Manager to show the current data transmission list.

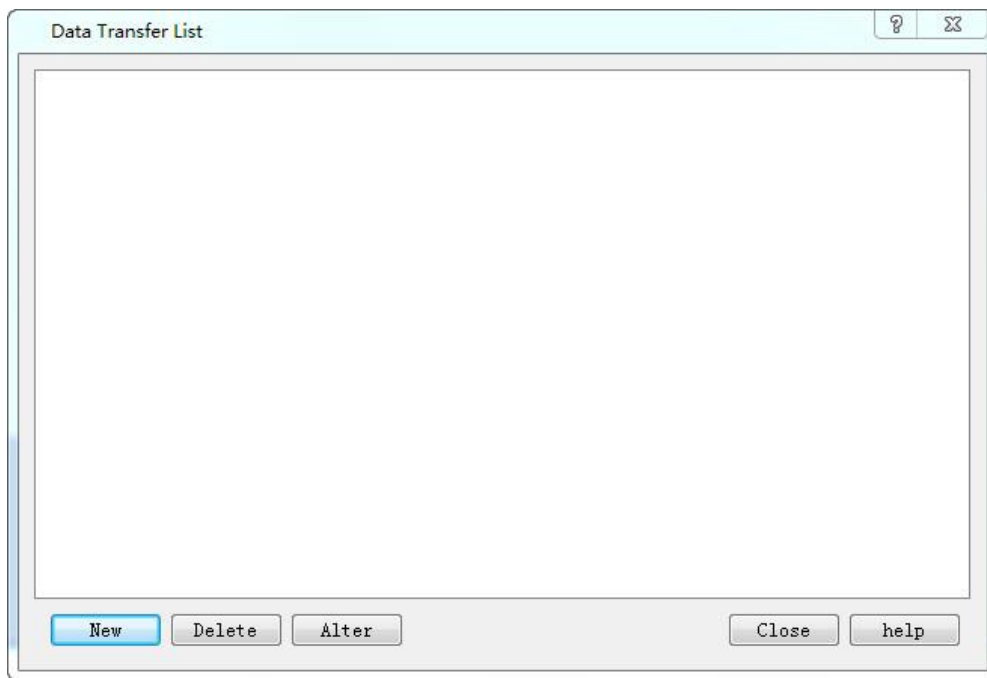

Figure 7-36

The transmission list lists details of all the current transmission items. Users can create, delete and modify them. SKTOOL configuration software supports up to 512 data transmission items.

To create a new one or modify an existing transmission item, it needs to enter the Property Setting page:

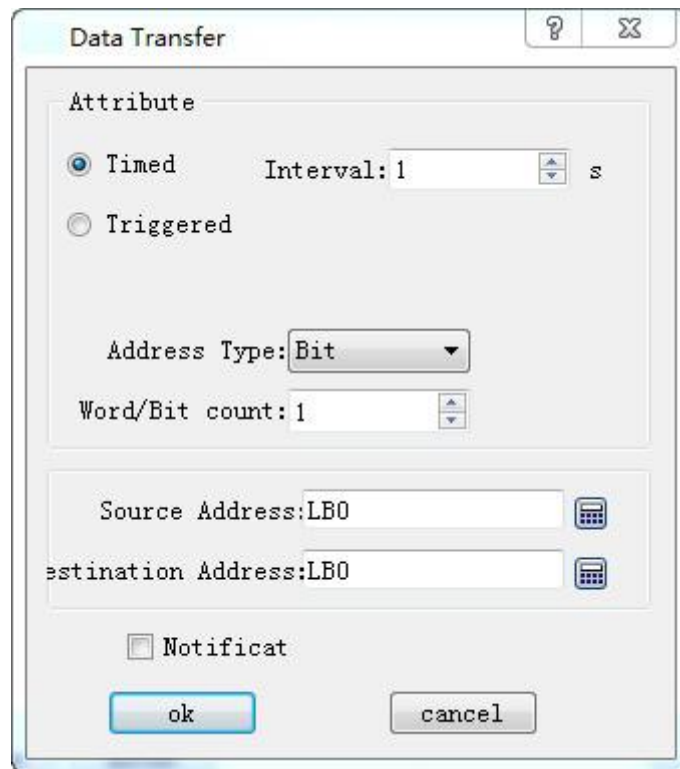

Figure 7-37

### 1. Attribute

Timing / Trige: Select the trigger mode for data transfer.

Timing: Perform data transfer at the set interval.

Triggering: The transmission signal is controlled by specified address. Execute this command when the address value is 1.

Automatic reset: When the value of address trigger is 1, set it automatically to 0.

Address Type: Select the address type to transfer data: Bit / Word / Double Word.

Word / Bit: Input the length of the data to be transferred. The length range is 1~ 64.

### 2. Address

Source Address: The source address of the transmitted data, which must be of the same type as the type of address set in the "Property".

Destination Address: The destination address of the transmitted data, which must be of the same type as the type of address set in the "Property".



Destination address and Source address cannot be on the same PLC.

## 9.9 Global Script



Set a script that has been successfully compiled into a global script, meaning executing this script when the configuration starts running, and it will be executed during the run time without being limited by screens. A maximum of 64 global scripts can be added, and they are executed in the set order.

Click "Global Script " on the menu "Settings", as shown in the dialog box:

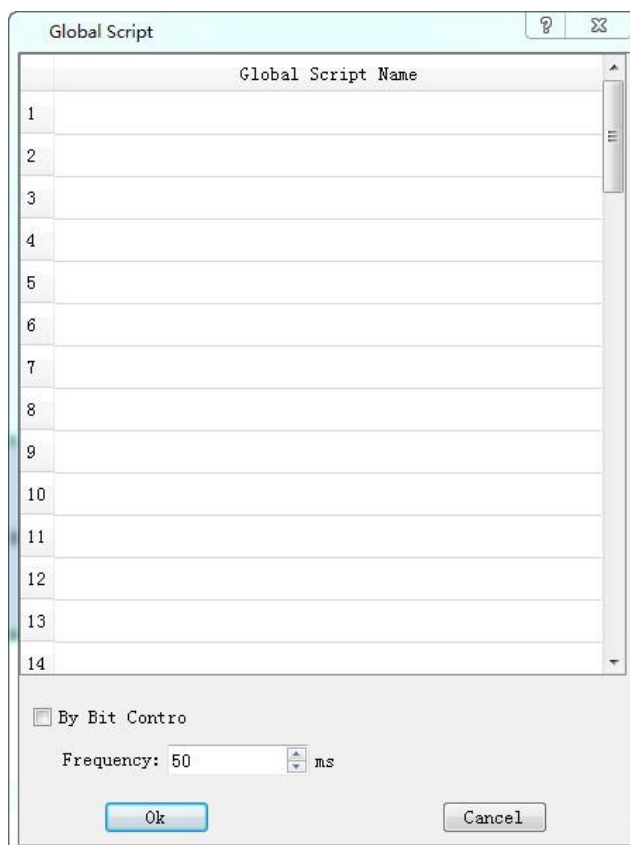

Click the list item to list all the script names that have been compiled successfully, and then decide whether the script is controlled by bit and the execution frequency. The selected script is executed as a global script during configuration run time.

---

## 9.10 Init Script



Set a script that has been successfully compiled into an Init script, meaning executing this script only one time without being limited by screens. A maximum of 64 init scripts can be added, and they are executed in the set order.

Click "Init Script " on the menu "Setting", as shown in the dialog box:



Click the list item to list all the script names that have been compiled successfully. The selected script is executed as a init macro during configuration run time.

## 9.11 Trigger\_Script



Set a script that has been successfully compiled into an trigger script, executing this script when the assigned condition is triggered. The trigger condition include screen/window skip,and address value change.

---

Click "Trigger Script" on the menu "Setting", as shown in the dialog box:

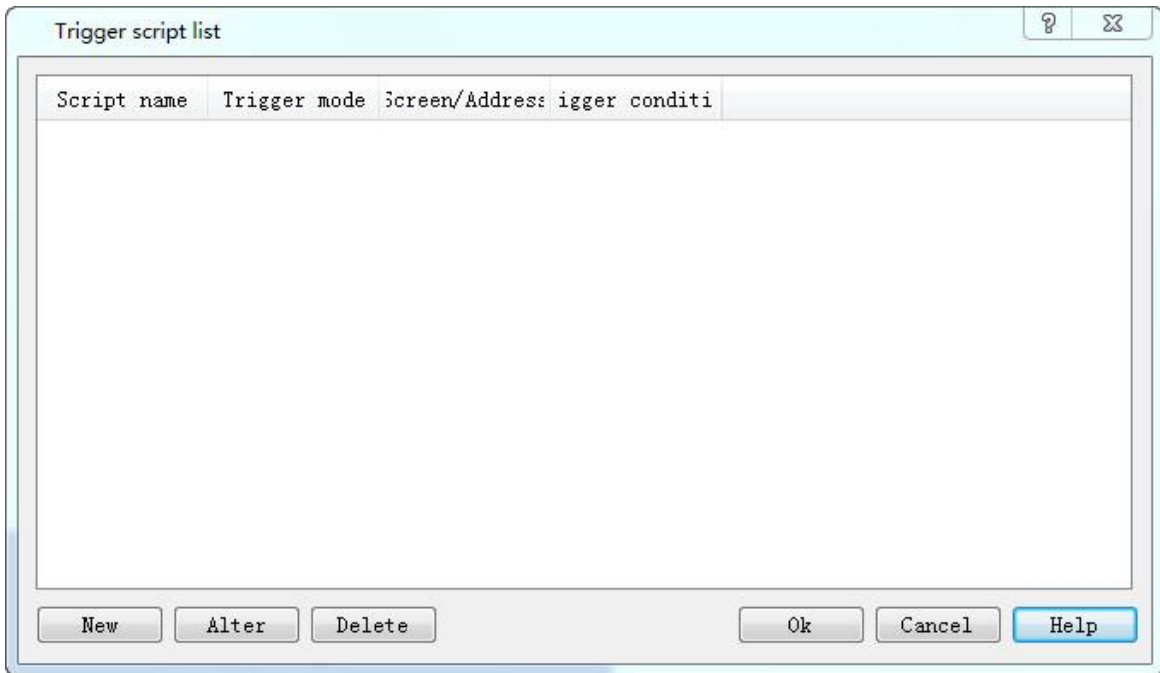

Figure7-45 Trigger Script dialog

Click the "New" button to pop up a new dialog. Then select a script is executed as a trigger script when the condition occur.

The trigger mode include address triggered and screen triggered.

Address Trigger:Set a Bit Address,select a trigger mode,include of OFF->ON,ON->OFF,OFF<->ON,Immediate execute when the status is ON.

Screen Trigger:Set a screen Name as trigger condition,select a trigger mode,include of Open Screen and Close Screen.

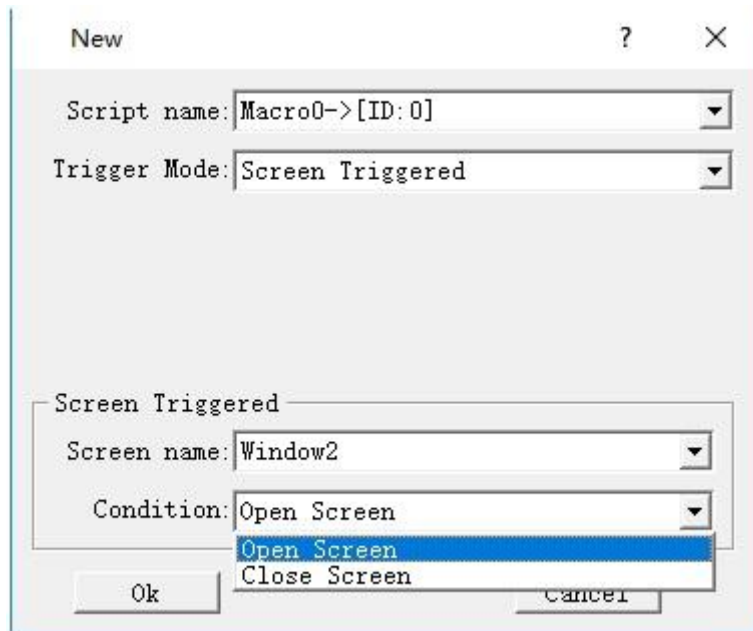
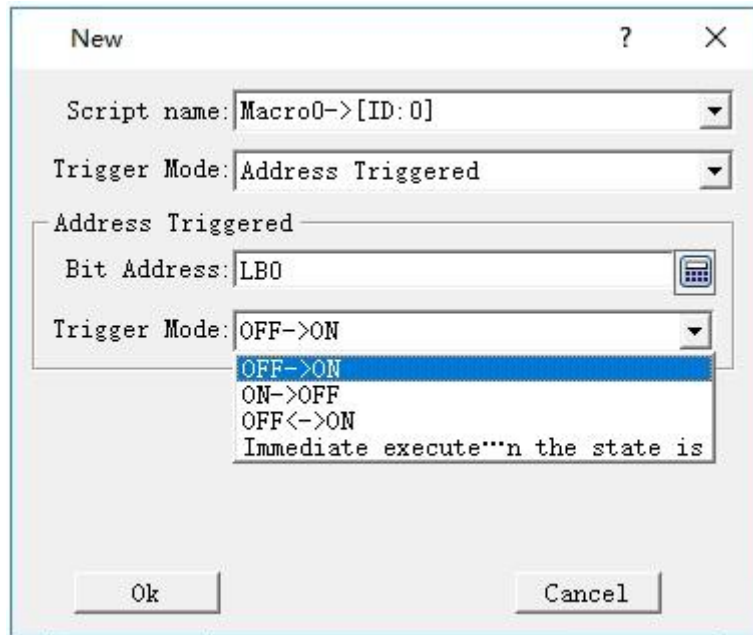

Figure7-46 new trigger script

You can use “Alter”and “Delete”button to operate the scripts,finally create a trigger script list.



| Script name      | Trigger mode    | Screen/Address | Trigger condition                      |
|------------------|-----------------|----------------|--|
| 1 Macro0->[ID:0] | Screen trigger  | Window2        | Open screen                            |
| 2 Macro1->[ID:1] | Address trigger | LB0            | OFF<->ON                               |
| 3 Macro2->[ID:2] | Address trigger | LB1            | Immediate execute When the state is on |
| 4 Macro3->[ID:3] | Screen trigger  | Window3        | Open screen                            |

Figure7-47 trigger script list

## 9.12 Data forwarding

### Function of Data Forwarding:

- 1、 Data Forwarding apply to transfer data between devices connected to two ports of HMI.

Example:

Select Modbus RTU Slave protocol for Port 1; Take HMI as slave station; master station Device 1 read the address of LW0 in HMI.

2. Select Modbus RTU Master protocol for Port 2; HMI reads the address of 4x11 of Slave station

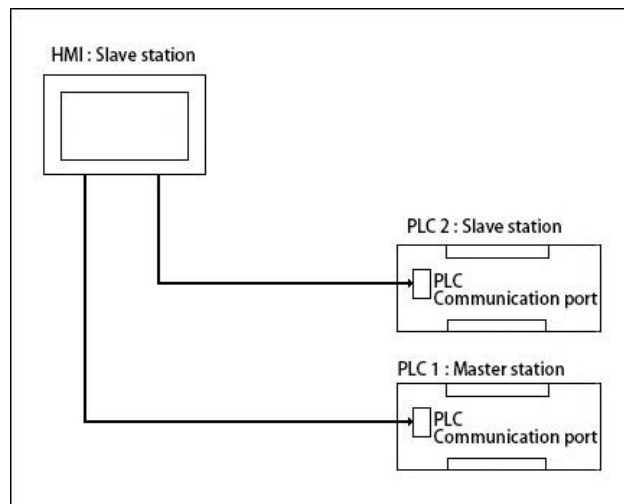

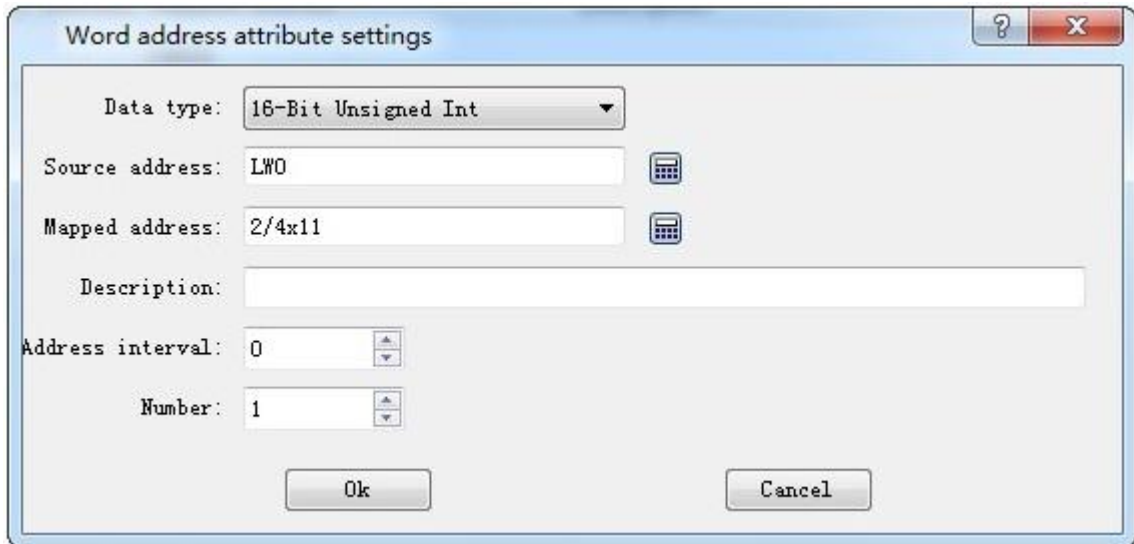

### 9.13 Schedule Table

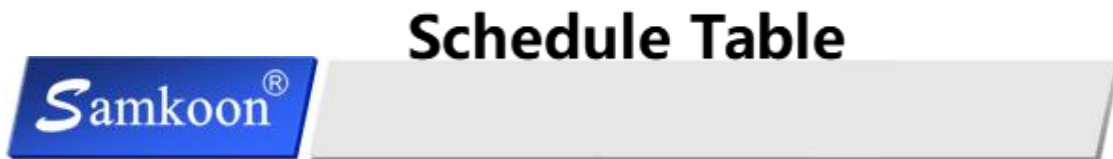

User can project some events according to the setting of schedule table. For example, a factory starts machines at 8:00 am, and closes machines at 18:00pm on weekday.

Click "Schedule Table" on "Standard List", it will pop up a schedule table dialog, as shown follow.

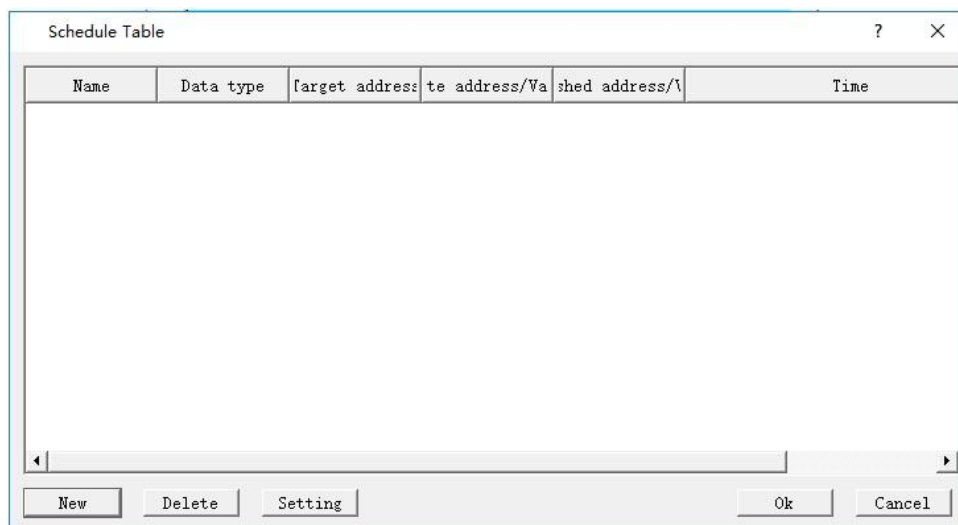

Figure 7-49 Schedule table dialog

Click "New" button, pop up a new dialog, as shown follow. The General page is first display.

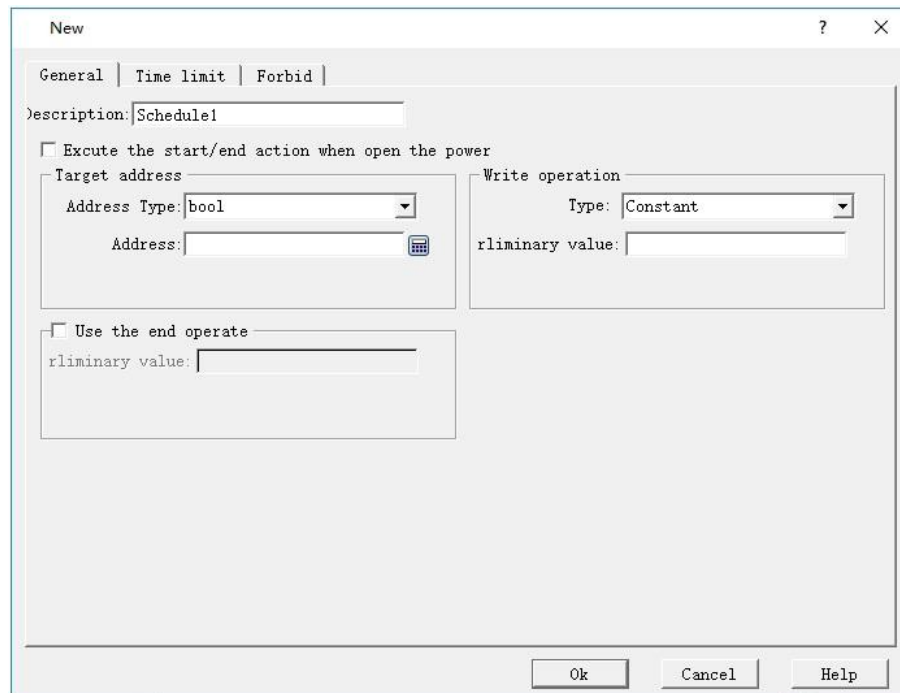

Figure 7-50 New schedule table dialog

- **Description:**  
Input text here in order to convenient for users to understand this schedule table's function.
- **Execute the start/end action when open the power:**  
If the power (HMI) open time is after the start time, Execute the start/end action.
- **Target address:**  
Input the target address type and address, the value of address will be wrote when the start/end time occurs.
- **Write operation:**  
Type include "Constant" and "Address". Below "Constant" type corresponds to Value that be wrote to target address. Below "Address" type corresponds to a address edit, the value of address will be wrote to target address value when start/end time occurs.
- **Use the end operate:**  
If this section is selection, the value of write operation will be wrote in target address when end time occurs.

After setting General, Click "Time limit" page, as shown follow.

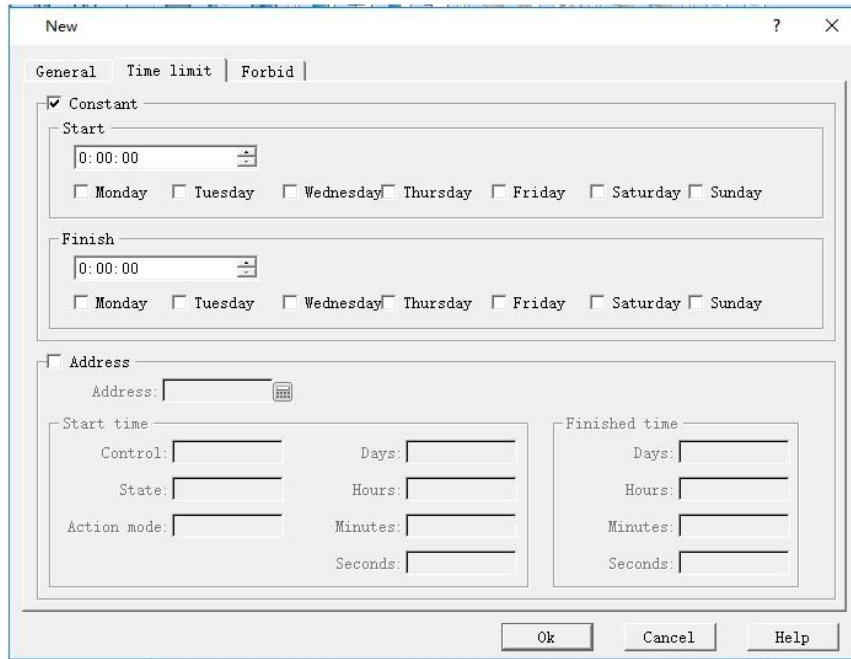

Figure 7-51 Time limit page

- constant: Check the Start/Finish time, when the tomes occur, it will operate the relevant write-in.
- Address: Using a piece of address to control the schedule table's start and end time, as shown follow.

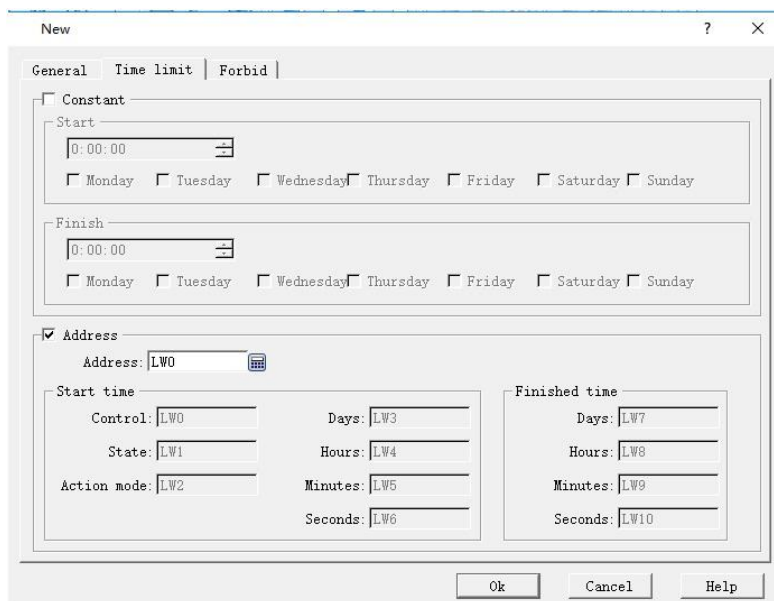

Figure 7-52 Setting address control

---

For example ,the address set to LW0, LW0~LW10 are used to schedule address.

LW0:Control address, when LW0 == 1, the schedule time is loaded on HMI.Schedule element starts work.After Loaded on,LW0 was reset to 0;

LW1:Schedule state, when schedule time is loaded(LW0==0),LW1 would be set to 1。

LW2:Action mode, when LW2 is set to 1, if current time is after the start time,operate the write action。 If LW2 is 0,when current time equals the start/end time,it will operate start/end operation.

LW3:the value indicates the day of start time, it's value equal to  $2^{(\text{number of week})}$ ,LW3 = (0,1,4,8,16,32,64)

LW4~LW6:the start time's hours,minute,seconds.

LW7:the value indicates the day of finished time, it's value equal to  $2^{(\text{number of week})}$ ,LW3 = (0,1,4,8,16,32,64)

LW8~LW10:the finished time's hours,minute,seconds.

Analogous, when LWn is set to control address, LWn~LWn+10 are used to schedule address, just like above。

**Tips:**If checked Address,Don't foget to set the control address to 1 in order to loadthe schedule after set the start/finished time.Otherwise,the schedule wouldn't work.

Fobid page,as shown follow:

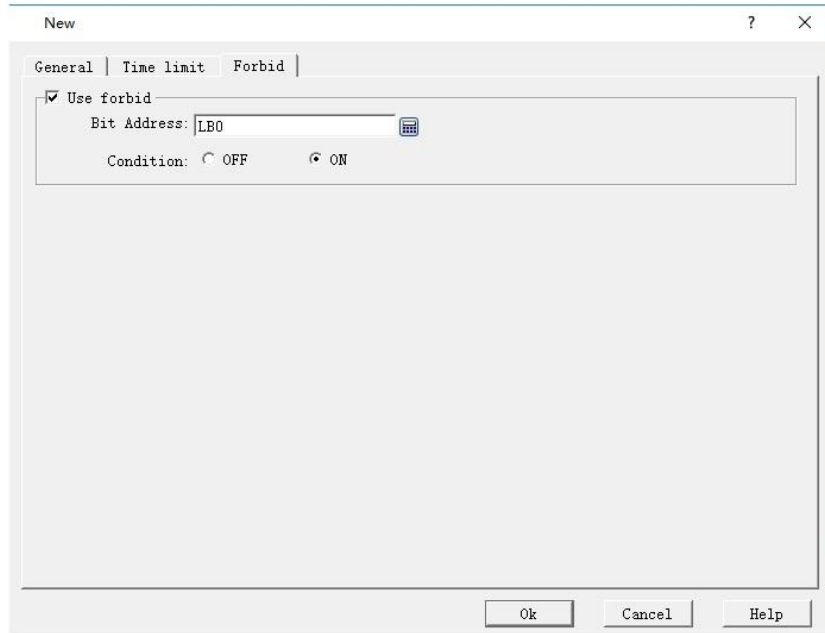

Figure 7-53 Forbid page

If check “use forbid”,when the bit address suit the condition(0 or 1),schedule can work.

After setting new dialog parameter,click “ok”,create a element of schedule table,as shown follow.

The image shows a dialog box titled 'Schedule Table' containing a table with the following data:

|   | Name      | Data type       | target address | te address/Va | shed address/\ | Time  |
|---|-----------|-----------------|----------------|---------------|----------------|-------|
| 1 | Schedule1 | bool            | LB0            | 0             | 1              | [TUE] |
| 2 | Schedule2 | 16-Bit Unsig... | LW0            | 100           | 200            | LW100 |

At the bottom of the dialog box are five buttons: 'New', 'Delete', 'Setting', 'Ok', and 'Cancel'.

Figure 7-50 Created schedule table

---

## 10. Reserved Registers of SKTOOL System



SKTOOL reserves some registers for special use, and users must refer to the related instructions when using these registers, including LB (Local Memory Bit); LW (Local Memory Register) and RWI (Formula Index).

For example:

LB: LB0-LB65535 and LB50000-LB51999 belong to the area of power failure protection;

LW: LW0-LW65535 and LW50000-LW51993 belong to the area of power failure protection. And LW51994~LW51999 are used by interior, not external;

RWI: RWI0~RWI65535.

### Contents:

- LB
- LW
- RWI

### 10.1 LB



| address     | instruction        | Notes   | read and write properties |
|-------------|--------------------|---|---------------------------|
| 60000-60099 | Initial setting ON | These bits can be initialized to ON at system startup | R/W                       |

|       |                              |  |     |
|-------|------------------------------|--|-----|
| 60100 | Recipe download              | Triggering this bit can write the data in the current RWI to the device, and reset it after completion               | R/W |
| 60101 | recipe upload                | Triggering this bit can read the recipe from the device to the RWI register area, reset after completion             | R/W |
| 60102 | Recipe save                  | Triggering this bit can write the recipe from RWI to FLASH, reset after completion                                   | R/W |
| 60103 | Recipe Download Instructions | When the recipe is being written to the device, this bit is ON, and it is OFF after downloading                      | R   |
| 60104 | Recipe upload instructions   | When the recipe is reading the device, this bit is ON, and it is OFF after downloading                               | R   |
| 60105 | Restart the HMI              | Triggering this bit restarts the system  | R   |
| 60106 | Backlight Control            | Control this bit to ON to turn off the LCD backlight, OFF to turn on the LCD backlight                               | R/W |
| 60107 | COM1 communication status    | When ON, the communication is normal or there is no communication, and when OFF, the communication fails abnormally. | R   |
| 60108 | COM2 communication status    | When ON, the communication is normal or there is no communication, and when OFF, the communication fails             | R   |



|       |  |   |     |
|-------|--|---|-----|
|       |  | abnormally.   |     |
| 60186 | COM3 communication status                          | When ON, the communication is normal or there is no communication, and when OFF, the communication fails abnormally.            | R   |
| 60109 | COM1 communication parameter modification storage  | Triggering this bit can write the modified communication parameters into the FLASH storage area, and turns OFF after completion | R/W |
| 60110 | COM2 communication parameter modification storage  | Triggering this bit can write the modified communication parameters into the FLASH storage area, and turns OFF after completion | R/W |
| 60187 | COM3 communication parameter modification storage  | Triggering this bit can write the modified communication parameters into the FLASH storage area, and turns OFF after completion | R   |
| 60111 | Confirmation and modification of system parameters | Triggering this bit can write the modified system parameters into the FLASH storage area, and turns OFF after completion        | R/W |
| 60112 | Communication exception window                     | When ON, the exception window is allowed to pop up, and when OFF, the exception window is prohibited from popping up.           | R/W |
| 60113 | mouse control                                      | When ON, the mouse cursor appears, and when OFF, the cursor is disabled (only when using touch)                                 | R/W |

|       |                                       |   |     |
|-------|---------------------------------------|---|-----|
| 60114 | USB connection status                 | When ON, there is a USB device connected, and when OFF, no USB device is connected.                       | R   |
| 60116 | touch sound                           | Whether there is a sound when touched or clicked with the mouse   | R/W |
| 60117 | alarm sound                           | Is there a sound when an alarm occurs?  | R/W |
| 60118 | Clear the historical alarm record     | The number of historical alarm records is cleared (automatic reset)                                       | R/W |
| 60119 | Operation record clear                | The number of operation records is cleared (automatic reset)  | R/W |
| 60120 | Clear historical data records         | Historical data record reset (automatic reset)  | R/W |
| 60121 | Overload recipe                       | Reload the recipe data of the current recipe serial number, this bit is ON, and it is OFF after reloading | R/W |
| 60123 | Save history alarms                   | When ON, save historical alarm records to flash, and automatically OFF after saving                       | R/W |
| 60124 | save historical data                  | When ON, save historical data to flash, and automatically OFF after saving                                | R/W |
| 60127 | Send historical alarm files to U disk | Send historical alarm files to U disk, automatically OFF after sending                                    | R/W |
| 60128 | Send historical data files to U disk  | Send historical data files to U disk, automatically OFF after sending                                     | R/W |

|       |   |   |     |
|-------|---|---|-----|
| 60129 | Send current project to U disk                                  | Send the project file to the U disk, and automatically turn off after sending   | R/W |
| 60133 | The current user is logged in and out                           | When ON, cancels user login and automatically resets after completion   | R/W |
| 60141 | There is a real-time alarm happening                            | When a real-time alarm occurs, this bit is ON   | R   |
| 60142 | The system is in a screen saver state                           | When in the screen saver state, this bit is ON  | R   |
| 60143 | Copy the operation record to the U disk                         | When ON, send the operation record file to the U disk, and automatically OFF after sending  | R/W |
| 60145 | Copy all recipes to U disk                                      | When ON, send the recipe file to the U disk, and automatically OFF after sending  | W   |
| 60147 | USB two-digit barcode scanner scan end mark                     | When ON, triggers   | R/W |
| 60148 | Import historical data from U disk trigger bit                  | When ON, trigger; auto reset. The file name of historical data imported by this function must be hisdata+group number.csv, otherwise this function will be invalid. | R/W |
| 60150 | Export the specified ID recipe to the trigger bit of the U disk | When ON, trigger; automatically reset   | R/W |
| 60152 | Import the  | When ON, trigger;   | R/W |

|       |  |  |     |
|-------|--|--|-----|
|       | specified ID recipe from the U disk to the HMI trigger bit | automatically reset  |     |
| 60154 | Clear the specified ID recipe trigger bit                  | When ON, trigger; automatically reset  | R/W |
| 60155 | Override Recipe Trigger Bit                                | When ON, trigger; automatically reset  | R/W |
| 60156 | Recipe read and save trigger bits                          | When ON, trigger; automatically reset  | R/W |
| 60163 | Export recipes to USB stick by group                       | When ON, trigger; automatically reset  | R/W |
| 60165 | Ethernet communication identification                      | ON: Normal communication<br>OFF: Communication abnormal  | R   |
| 60167 | Scan U disk files  | When ON, trigger; automatic reset, scan the .csv files in the root directory and subdirectories of the U disk, and display them in a pop-up window for import and export of recipe files | R/W |
| 60168 | Export historical data to U disk in groups                 | When ON, trigger; automatically reset, LW60408 sets the export history data group number   | R/W |
| 60169 | Station number disable mode selection                      | ON: Automatic mode<br>OFF: Manual mode (default option)<br>Automatic station number disabling and unlocking:<br>When the touch screen uses the extended mode to                          | R/W |

|       |  |   |     |
|-------|--|---|-----|
|       |  | communicate with multiple devices, a device fails and cannot communicate, the application program automatically disables the station number communication, and there is an automatic reconnection mechanism inside, when the device can communicate normally , automatically unblock, restore communication |     |
| 60173 | Controls whether the VNC function is enabled             | When ON, the VNC function is enabled; when OFF, the VNC function is disabled  | R/W |
| 60176 | Check if a SIM card is inserted                          | When ON, SIM card insertion is detected; when OFF, SIM card insertion is not detected   | R   |
| 60177 | Update HMI SN code information                           | Triggered when ON, update HMI SN code information   | R/W |
| 60178 | TCP communication parameter modification enable flag bit | When using the standard mode to connect an Ethernet device, dynamically modify the IP, port number, station number and other parameters of the connected device, and the setting will take effect. For details, please refer to the 63186~63191 address description of <a href="#">LW</a> .                 | R/W |
| 60179 | Dynamic password key modification enable flag            | Set dynamic password key, set to take effect, automatically reset, key setting address: LW63147   | R/W |

|       |  |  |     |
|-------|--|--|-----|
|       |  | Data type: ASCII Length: 6   |     |
| 60180 | Recipe name change trigger bit   | LW63153 (ASCII input control, length 32), after the formula name is entered, this address will take effect and automatically reset after completion  | R/W |
| 60181 | Dynamic password enable flag   | Set whether the dynamic password function is enabled<br>0; disable dynamic password<br>1: enable dynamic password  | R/W |
| 60182 | Dynamic password expiration time setting flag                            | Set the dynamic password expiration time, year, month, day, hour: LW63141 ~ 63146<br>Data type: 16-bit integer, setting the date set after the completion LB60182, set to take effect automatically reset<br><b>Note: Password protection process does not allow dynamic updating firmware or dial Code 1.3 to modify the system time, the firmware can be updated after entering the super password</b> | R/W |
| 60183 | Data in the power-off hold area is immediately stored as the trigger bit | Q series touch screen by default, the data in the power-off hold area will be automatically stored for 1 minute. By setting this address, the data in the power-off hold area will be stored immediately and automatically reset.  | R/W |

## 10.2 LW



| address     | instruction  | Notes  | read and write properties |
|-------------|--|--|---------------------------|
| 59010~59057 | <p>In the extended mode, the communication of the specified station number is disabled.</p> <p>Corresponding station number 0~255, each address corresponds to 16 station numbers, 59010 means station number 0~15, and so on</p> <p>The X-th bit is 1, allowing the communication with the X station number, and when it is 0, the communication with the X station number is closed.</p> | <p>COM1: 59010~59025</p> <p>COM2: 59026~59041</p> <p>Ethernet: 59042~59057</p> | R/W                       |
| 59058~59105 | <p>The extended mode disables the communication identification of the specified station</p>  | <p>COM1: 59058~59073</p> <p>COM2: 59074~59089</p> <p>Ethernet: 59090~59105</p> | R                         |

|       |   |   |     |
|-------|---|---|-----|
|       | <p>number<br/>Corresponding station number 0~255, each address corresponds to 16 station numbers, 59058 means station number 0~15, and so on</p> <p>The Xth bit is 1, the communication of this station number is disabled, and if it is 0, the communication of this station number is normal.</p> |   |     |
| 60000 | local time seconds  | Bcd code, valid value range 0-59            | R/W |
| 60001 | local time  | Bcd code, valid value range 0-59            | R/W |
| 60002 | local time  | Bcd code, valid value range 0-23            | R/W |
| 60003 | local time day  | Bcd code, valid value range 1-31            | R/W |
| 60004 | local time month  | Bcd code, valid value range 1-12            | R/W |
| 60005 | local time year   | Bcd code, valid value range 0-9999          | R/W |
| 60006 | local time week   | Bcd code, valid value range 1-7             | R   |
| 60007 | system runtime  | The time the system has been running, hours | R   |
| 60008 | system running time   | System elapsed time, minutes                | R   |



|       |  |   |   |
|-------|--|---|---|
| 60009 | System runtime in seconds                        | System elapsed time, seconds  | R |
| 60010 | Current screen window number                     | The serial number of the current screen   | R |
| 60012 | current language                                 | Corresponding language serial number  | R |
| 60013 | Numerical input allowable upper limit value      | When the custom keyboard pops up, the upper limit of the allowed input is displayed in ASCII            | R |
| 60023 | Numerical input allowable lower limit value      | When the custom keyboard pops up, the lower limit of the allowed input is displayed in ASCII            | R |
| 60033 | The input data content displayed on the keyboard | The input data content displayed on the keyboard, the characters input from the keyboard, ASCII display | R |
| 60065 | The current system login user                    | current user serial number  | R |
| 60066 | Current system login user password               | Display the current user's password, 16 characters, ASCII display                                       | R |
| 60074 | The current system login user name               | Display the current user name, 32 characters, ASCII display   | R |
| 60090 | Whether user 1 is enabled                        | 0 - not enabled, 1 - enabled  | R |
| 60091 | Whether user 2 is enabled                        | 0 - not enabled, 1 - enabled  | R |
| 60092 | Whether user 3 is enabled                        | 0 - not enabled, 1 - enabled  | R |
| 60093 | Whether user 4 is enabled                        | 0 - not enabled, 1 - enabled  | R |

|       |                           |                              |   |
|-------|---------------------------|------------------------------|---|
|       | enabled                   | enabled                      |   |
| 60094 | Whether user 5 is enabled | 0 - not enabled, 1 - enabled | R |
| 60095 | Whether user 6 is enabled | 0 - not enabled, 1 - enabled | R |
| 60096 | Whether user 7 is enabled | 0 - not enabled, 1 - enabled | R |
| 60097 | Whether user 8 is enabled | 0 - not enabled, 1 - enabled | R |
| 60098 | User 1 first name         | 32 characters, ASCII display | R |
| 60114 | User 2 first name         | 32 characters, ASCII display | R |
| 60130 | User 3 name               | 32 characters, ASCII display | R |
| 60146 | User 4 first name         | 32 characters, ASCII display | R |
| 60162 | User 5 name               | 32 characters, ASCII display | R |
| 60178 | User 6 name               | 32 characters, ASCII display | R |
| 60194 | User 7 first name         | 32 characters, ASCII display | R |
| 60210 | User 8 first name         | 32 characters, ASCII display | R |
| 60226 | User 1 password           | 16 characters, ASCII display | R |
| 60234 | User 2 password           | 16 characters, ASCII display | R |
| 60242 | User 3 password           | 16 characters, ASCII display | R |
| 60250 | User 4 password           | 16 characters, ASCII display | R |

|       |   |   |     |
|-------|---|---|-----|
| 60258 | User 5 password                             | 16 characters, ASCII display  | R   |
| 60266 | User 6 password                             | 16 characters, ASCII display  | R   |
| 60274 | User 7 password                             | 16 characters, ASCII display  | R   |
| 60282 | User 8 password                             | 16 characters, ASCII display  | R   |
| 60290 | screen saver time                           | Display the screen saver time specified during configuration, the setting range is 0~60     | R/W |
| 60291 | Indicator flashing cycle                    | The blinking period of the indicator light control, the minimum value is 0.1, the unit is s | R/W |
| 60292 | The position of the X when touched          | The position of the X coordinate when touched   | R   |
| 60293 | Y's position when touched                   | The position of the Y coordinate when touched   | R   |
| 60294 | The position of the X when the touch leaves | The position of the X coordinate when the touch leaves                                      | R   |
| 60295 | The position of Y when the touch leaves     | The position of the Y coordinate when the touch leaves                                      | R   |
| 60296 | touch state                                 | 1-touch, 0-release  | R   |
| 60297 | Checkout of COM1                            | Communication parameters, calibration, 0-NONE, 1-EVEN, 2-ODD                                | R/W |
| 60298 | Baud rate of COM1                           | Communication parameters, baud rate, 0-1200, 1-2400, 2-4800, 3-9600, 4-19200,               | R/W |

|       |                                       |   |     |
|-------|---------------------------------------|---|-----|
|       |                                       | 5-38400, 6-57600,<br>7-115200   |     |
| 60299 | stop bit of COM1                      | Communication parameters, stop bits, 0-1stops, 1-2stops                                 | R/W |
| 60300 | Data length of COM1                   | Communication parameters, data length, 0-7bits, 1-8bits                                 | R/W |
| 60301 | HMI address of COM1                   | Communication parameters, HMI address   | R/W |
| 60302 | PLC address of COM1                   | Communication parameters, PLC address   | R/W |
| 60303 | COM1 PLC consecutive address interval | The length of the maximum continuous address that can be read in a single communication | R/W |
| 60304 | COM1 communication time               | Communication delay time  | R/W |
| 60305 | COM1 retries                          | The number of times the system resends when the communication is abnormal               | R/W |
| 60306 | COM1 address mode                     | Address mode, 0-standard mode, 1-extended mode  | R   |
| 60307 | COM1 communication timeout time       | Set the communication timeout time, in ms   | R/W |
| 60308 | COM1 communication current wait time  | The current waiting time of communication, in ms  | R/W |
| 60309 | COM1 HMI location                     | 0-local 1-remote  | R/W |
| 60312 | Checksum of COM2                      | Communication   | R/W |

|       |  |   |     |
|-------|--|---|-----|
|       |  | parameters, calibration,<br>0-NONE, 1-EVEN, 2-ODD   |     |
| 60313 | Baud rate of COM2                          | Communication<br>parameters, baud rate,<br>0-1200, 1-2400, 2-4800,<br>3-9600, 4-19200,<br>5-38400, 6-57600,<br>7-115200 | R/W |
| 60314 | stop bit of COM2                           | Communication<br>parameters, stop bits,<br>0-1stops, 1-2stops   | R/W |
| 60315 | Data length of COM2                        | Communication<br>parameters, data length,<br>0-7bits, 1-8bits   | R/W |
| 60316 | HMI address of<br>COM2                     | Communication<br>parameters, HMI address  | R/W |
| 60317 | PLC address of<br>COM2                     | Communication<br>parameters, PLC address  | R/W |
| 60318 | COM2 PLC<br>continuous address<br>interval | The length of the<br>maximum continuous<br>address that can be read<br>in a single<br>communication                     | R/W |
| 60319 | COM2<br>communication time                 | Communication delay<br>time   | R/W |
| 60320 | COM2 retries                               | The number of times the<br>system resends when the<br>communication is<br>abnormal                                      | R/W |
| 60321 | COM2 address mode                          | Address mode,<br>0-standard mode,<br>1-extended mode  | R   |
| 60322 | COM2<br>communication<br>timeout time      | Set the communication<br>timeout time, in ms  | R/W |

|       |                                      |  |     |
|-------|--------------------------------------|--|-----|
| 60323 | COM2 communication current wait time | The current waiting time of communication, in ms   | R/W |
| 60324 | COM2 HMI location                    | 0-local, 1-remote  | R/W |
| 61270 | Checksum of COM3                     | Communication parameters, calibration, 0-NONE, 1-EVEN, 2-ODD   | R/W |
| 61271 | Baud rate of COM3                    | Communication parameters, baud rate, 0-1200, 1-2400, 2-4800, 3-9600, 4-19200, 5-38400, 6-57600, 7-115200 | R/W |
| 61272 | stop bit of COM3                     | Communication parameters, stop bits, 0-1stops, 1-2stops  | R/W |
| 61273 | Data length of COM3                  | Communication parameters, data length, 0-7bits, 1-8bits/td>  | R/W |
| 61274 | HMI address of COM3                  | Communication parameters, HMI address  | R/W |
| 61275 | PLC address of COM3                  | Communication parameters, PLC address  | R/W |
| 61276 | COM3 PLC continuous address interval | The length of the maximum continuous address that can be read in a single communication                  | R/W |
| 61277 | COM3 communication time              | Communication delay time   | R/W |
| 61278 | COM3 retries                         | The number of times the system resends when the communication is abnormal                                | R/W |
| 61279 | COM3 address mode                    | Address mode, 0-standard mode, 1-extended mode   | R/W |
| 61280 | COM3 communication timeout time      | Set the communication timeout time, in ms  | R/W |
| 61281 | COM3 communication                   | The current waiting time of  | R/W |

|       |  |  |               |
|-------|--|--|---------------|
|       | current wait time  | communication, in ms   |               |
| 61282 | COM3 HMI location  | 0-local, 1-remote  | R             |
| 60327 | Number of historical alarms  | The total number of historical alarms that occurred that were recorded | R/double word |
| 60329 | Number of historical records   | The total number of historical data records recorded                   | R/double word |
| 60333 | keyboard language switch   | 1-Chinese keyboard, 0-English keyboard, for standard keyboard          | R/W           |
| 60334 | CPU usage  | CPU runtime usage of the current system                                | R             |
| 60335 | The current brightness value of the backlight  | The current brightness value of the backlight (140~450)                | R/W           |
| 60337 | Current project creation time year   | Current project file creation time year                                | R             |
| 60338 | Current project creation time month  | Current project file creation time month                               | R             |
| 60339 | Current project creation date and time   | The current project file creation date and time                        | R             |
| 60340 | current user language  | set current language   | W             |
| 60359 | When equal to 1, copy the historical alarms of the specified serial number range to the U disk |  | R/W           |
| 60361 | When equal to 1, copy the historical   |  | R/W           |

|       |  |  |     |
|-------|--|--|-----|
|       | alarms of the specified time range to the U disk   |  |     |
| 60363 | Export historical alarm start sequence number  |  | R/W |
| 60365 | Export historical alarm end sequence number  |  | R/W |
| 60367 | Export history alarm start time  | The length is 6 characters, which are the year, month, day, hour, minute and second. | R/W |
| 60373 | Export historical alarm end time   | The length is 6 characters, which are the year, month, day, hour, minute and second. | R/W |
| 60379 | File name when exporting historical alarms to U disk   | 22 characters long   | R/W |
| 60408 | The current group number control address of the historical data                              | Specify the current group number of historical data                                  | R/W |
| 60409 | When equal to 1, copy the historical data of the specified serial number range to the U disk |  | R/W |
| 60411 | When equal to 1, copy the historical data of the specified time range to the U disk          |  | R/W |
| 60413 | Export historical data   |  | R/W |



|       |  |   |     |
|-------|--|---|-----|
|       | start sequence number                              |   |     |
| 60415 | Export historical data end sequence number         |   | R/W |
| 60417 | Export historical data start time                  | The length is 6 characters, which are the year, month, day, hour, minute and second.  | R/W |
| 60423 | End time of exporting historical data              | The length is 6 characters, which are the year, month, day, hour, minute and second.  | R/W |
| 60429 | File name when exporting historical data to U disk | 24 characters long  | R/W |
| 60441 | Modify User 1 Password Cache                       | 16 characters long, ASCII display   | R/W |
| 60449 | Enable to modify the password of user 1            | When it is 1, the password of user 1 will be changed to the password of the cache area, and it will be reset automatically after setting. | R/W |
| 60451 | Modify User 2 Password Cache                       | 16 characters long, ASCII display   | R/W |
| 60459 | Enable to modify the password of user 2            | When it is 1, the password of user 2 will be changed to the password of the cache area, and it will be reset automatically after setting. | R/W |
| 60461 | Modify User 3                                      | 16 characters long, ASCII   | R/W |

|       |   |   |     |
|-------|---|---|-----|
|       | Password Cache                          | display   |     |
| 60469 | Enable to modify the password of user 3 | When it is 1, the password of user 3 will be changed to the password of the cache area, and it will be reset automatically after setting. | R/W |
| 60471 | Modify User Password Cache              | 4 16 characters long, ASCII display   | R/W |
| 60479 | Enable to modify the password of user 4 | When it is 1, the password of user 4 will be changed to the password of the cache area, and it will be reset automatically after setting. | R/W |
| 60481 | Modify User Password Cache              | 5 16 characters long, ASCII display   | R/W |
| 60489 | Enable to modify the password of user 5 | When it is 1, the password of user 5 will be changed to the password of the cache area, and it will be reset automatically after setting. | R/W |
| 60491 | Modify User Password Cache              | 6 16 characters long, ASCII display   | R/W |
| 60499 | Enable to modify the password of user 6 | When it is 1, the password of user 6 will be changed to the password of the cache area, and it will be reset automatically after setting. | R/W |

|       |   |   |     |
|-------|---|---|-----|
| 60501 | Modify user 7 password cache            | 16 characters long, ASCII display   | R/W |
| 60509 | Enable to modify the password of user 7 | When it is 1, the password of user 7 will be changed to the password of the cache area, and it will be reset automatically after setting. | R/W |
| 60511 | Modify User 8 Password Cache            | 16 characters long, ASCII display   | R/W |
| 60519 | Enable to modify the password of user 8 | When it is 1, the password of user 8 will be changed to the password of the cache area, and it will be reset automatically after setting. | R/W |
| 60520 | HMI model                               | 40 characters   | R   |
| 60540 | bootloader version number               | 40 characters   | R   |
| 60560 | OS version number                       | 40 characters   | R   |
| 60580 | software version number                 | 40 characters   | R   |
| 60600 | Operation record enable                 | When it is 1, the operation record is allowed to be recorded  | R/W |
| 60601 | Number of operation records             | Display the number of current operation records   | R   |
| 60602 | Screen capture enabled                  | When it is 1, enable screen capture and reset automatically after setting   | R/W |
| 60603 | Screenshot storage                      | 0-U disk  | R/W |

|             |  |   |     |
|-------------|--|---|-----|
|             | location   |   |     |
| 60604       | Enable HMI protection                                      | When 1, use HMI protection  | R/W |
| 60605       | Set the total number of password levels for HMI protection | Set the total number of password levels for HMI protection, up to 15 passwords can be set   | R/W |
| 60606-60835 | Setting the lifetime of the HMI protection                 | <p>60606-60628 is the year, month, day, hour, minute, second and expiration prompt screen of the level 1 password and the unlock password (the password length is 16 characters)</p> <p>60629-60651 is the year, month, day, hour, minute, second and expiration prompt screen of the level 2 password, and the unlock password (password length is 16 characters)</p> <p>60652-60674 are the year, month, day, hour, minute, second, and expiration prompt screens for level 3 passwords, as well as the unlock password (password length is 16 characters)</p> <p>60675-60697 is the year, month, day, hour, minute, second and expiration prompt screen of the</p> | R/W |

|  |  |   |  |
|--|--|---|--|
|  |  | <p>4-level password and the unlock password (password length is 16 characters)</p> <p>60698-60720 is the year, month, day, hour, minute, second and expiration prompt screen of the 5-level password and the unlock password (the password length is 16 characters)</p> <p>60721-60743 are the year, month, day, hour, minute, second and expiration prompt screen of the 6-level password and the unlock password (password length is 16 characters)</p> <p>60744-60766 is the year, month, day, hour, minute, second and expiration prompt screen of the 7-level password and the unlock password (the password length is 16 characters)</p> <p>60767-60789 is the year, month, day, hour, minute, second and expiration prompt screen of the 8-level password and the unlock password (the password length is 16 characters)</p> <p>60790-60812 is the year,</p> |  |
|--|--|---|--|

|             |  |  |  |
|-------------|--|--|--|
|             |  | <p>month, day, hour, minute, second and expiration prompt screen of the 9-level password and the unlock password (password length is 16 characters)</p> <p>60813-60835 is the year, month, day, hour, minute, second and expiration prompt screen of the 10-level password and the unlock password (the password length is 16 characters)</p>  |  |
| 63000-63114 | Setting the lifetime of the HMI protection | <p>63000-63022 is the year, month, day, hour, minute, second and expiration prompt screen of the 11-level password and the unlock password (the password length is 16 characters)</p> <p>63023-63045 is the year, month, day, hour, minute, second and expiration prompt screen of the 12-level password and the unlock password (password length is 16 characters)</p> <p>63046-63068 is the year, month, day, hour, minute, second and expiration prompt screen of the 13-level password and</p> |  |

|             |  |  |     |
|-------------|--|--|-----|
|             |  | <p>the unlock password (password length is 16 characters)</p> <p>63069-63091 is the year, month, day, hour, minute, second and expiration prompt screen of the 14-level password and the unlock password (the password length is 16 characters)</p> <p>63092-63114 are the year, month, day, hour, minute, second and expiration prompt screens for the 15-level password and the unlock password (password length is 16 characters)</p> |     |
| 63115~63130 | The highest level password to modify the input address | 63115~63131 The highest level password modification address (password length is 16 characters), after the input is completed, enter 1 in LW63131 to make the currently set password effective  | R/W |
| 63131       | Highest level password enable address                  | 63115~63130 After the highest level password input is completed, enter 1 in this address to make the highest level password effective  | R/W |
| 60836       | Enable store to HMI                                    | When it is 1, the HMI protection setting is  | R/W |

|                |   |   |     |
|----------------|---|---|-----|
|                |   | stored in the HMI, and the setting is automatically reset.  |     |
| 60837          | Initialize HMI protection state   | Reset the HMI protection to the initial state. Unlocked users need to unlock again                                | W   |
| 60997          | USB input function assignment.  | Default is 0, USB keyboard input or USB mouse operation. When it is 1, it is used for scanning gun scanning input | R/W |
| 60998          | USB two-digit barcode scanning end symbol definition 0-ENTER, 1-TAB+ENTER |   | R/W |
| 60999          | USB two-digit barcode scan code length                                    |   | R/W |
| 61000<br>61127 | Two-digit barcode scanning code storage and use                           |   | R/W |
| 61128          | Use of printer parameters   |   | R/W |
| 61138          | Import recipe source recipe ID number                                     |   | R/W |
| 61139          | Import recipe destination recipe ID number                                |   | R/W |
| 61140          | Clear recipe ID number  | -1 when the initial value is displayed using a 16-bit integer; otherwise, 65535                                   | R/W |
| 61141          | Switch the current  |   | R/W |



|             |  |   |     |
|-------------|--|---|-----|
|             | recipe group number when the HMI is running                              |   |     |
| 61143       | Specify the group number when importing and exporting the formula U disk |   | R/W |
| 61216~61247 | HMI SN code information  | ASCII display control, the total number of characters is up to 64, display HMI SN code information                        | R   |
| 61250       | Signal Quality Information   | Display the signal quality of the HMI network connection in the current environment                                       | R   |
| 61251       | Type of network connection   | 1: wifi, 2: China Mobile, 3: China Unicom, 4: China Telecom, 5: unknown   | R   |
| 61259~61269 | IoT Card ICCID Information   | ASCII display control, the total number of characters is up to 20, and the ICCID information of the IoT card is displayed | R   |
| 62020-62039 | Current recipe name  | ASCII display control, unicode encoding, length 20, Display the current recipe name                                       | R   |
| 62040       | User login level selection   | Set the user level that needs to be logged in, here corresponds to the user level checked in the                          | R/W |

|             |   |  |     |
|-------------|---|--|-----|
|             |   | "touch screen parameter setting" ?? "user password setting" option   |     |
| 62041~62056 | User login password input address         | Correctly enter 62040 to set the corresponding password of the user level. The highest authority password can unlock the current user level of all levels (the password length is 16 characters), and complete the user login operation. | R/W |
| 62057       | HMI delay times limit register            | Check the delay option in HMI protection settings, you can modify the number of delays here, the default value is 1  | R/W |
| 63141~63146 | Dynamic Password Expiration Time Settings | Year, month, day, hour, minute, second: LW63141~63146 Data type: 16-bit integer, set LB60182 after setting the date, the setting will take effect and reset automatically  | R/W |
| 63147~63152 | Dynamic password key setting address      | Modify the dynamic password key, set address: LW63147 Data type: ASCII Length: 6, set LB60179 to take effect after setting, and reset automatically  | R/W |
| 63153~63184 | Formula Name Modification                 | ASCII input control, length 32, modified   | W   |

|             |                                       |   |     |
|-------------|---------------------------------------|---|-----|
|             |                                       | LB60180 take effect<br>IP, port number, station number After the setting is completed, set LB60178 to take effect   |     |
| 63186~63189 | IP address of the Ethernet device     | The IP address of the Ethernet device in the standard mode, data type: 16-bit integer<br>IP, port number, station number After the setting is completed, set LB60178 to take effect | R/W |
| 63190       | Station number of the Ethernet device | The station number of the Ethernet device in standard mode, data type: 16-bit integer<br>IP, port number, and station number are set to take effect after setting LB60178           | R/W |
| 63191       | Port number of the Ethernet device    | The port number of the Ethernet device in standard mode, data type: 16-bit integer<br>IP, port number, station number After the setting is completed, set LB60178 to take effect    | R/W |

### 10.3 RWI



---

| address | instruction            | Notes  |
|---------|------------------------|--|
| RWI0    | Recipe number register | Displays the recipe specified by the recipe number                                   |
| RWI1    | Recipe memory address  | Specifying the recipe number can display the data corresponding to the recipe in RWI |

---

# 11. Connection among multiple screens and machines

---

This chapter introduces multipoint connection of Samkoon HMI series touch screen that is “one machine with multiple screens” connection, “one screen with multiple machines” connection, and the very useful function penetration connection.

## Contents

- [“One machine with multiple screens” connection](#)
- [“One screen with multiple machines” connection](#)
- [Penetration connection](#)
- [Modbus TCP/IP](#)

## 11.1 “One machine with multiple screens” connection



Samkoon HMI series touch screen allows “one machine with multiple screens” connection for PLC via MODBUS protocol. All touch screens are connected one by one, and the first screen is connected with PLC. All touch screens may be set as Slave Station, and PLC set as Master Station. Double click “COM1 connection” on the project manager, and then a communication port attribute-setting box will pop up. In Equipment Service item of General option in this box, choose Modbus RTU, and choose Modbus RTU Slave on the right; alternatively, set the first touch screen connected with the PLC as the Master Station, and set the PLC and other screens as the Slave Station. In this case, when setting the communication port attributes of the first screen, choose Modbus RTU in Equipment Service item of General option, choose Modbus RTU Master on the right, change the mode to Extended Mode in the Parameter option, and allocate addresses of touch screens. Thus, the touch screens set as Slave Station may communicate with PLC through the first touch screen. In both of these two arrangements, only Master Station can communicate with

Slave Station, and no communication among Slave Stations can be achieved.

When the PLC is set as Master Station and all touch screens are set as Slave Station:

1. The communication port of the PLC connected is RS232; connection methods and system settings are as shown in Figure 8-1, 8-2 and 8-3:

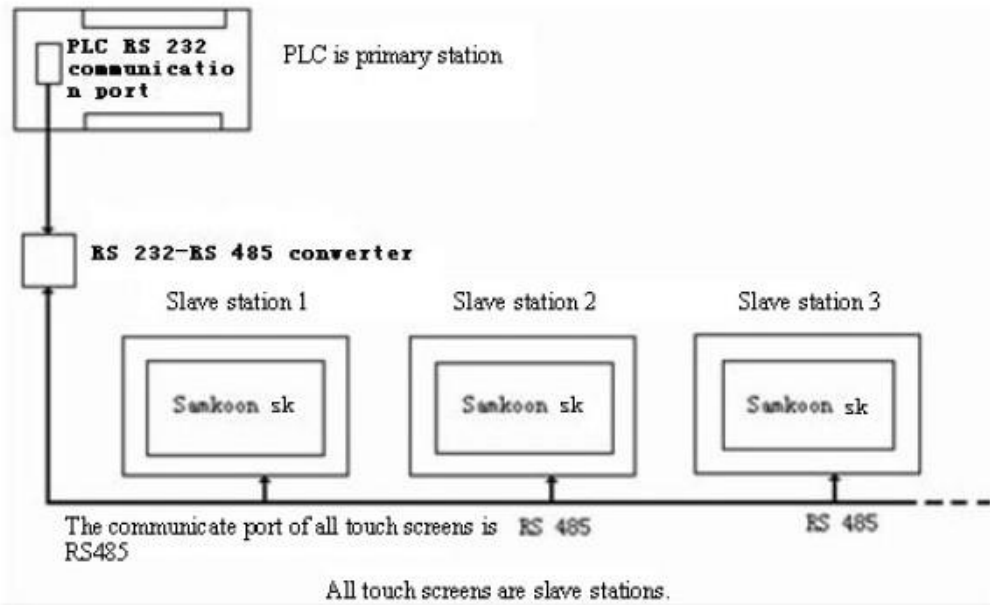

Figure 8-1 Sketch map of “One machine with multiple machines” when PLC(RS232) is Master station

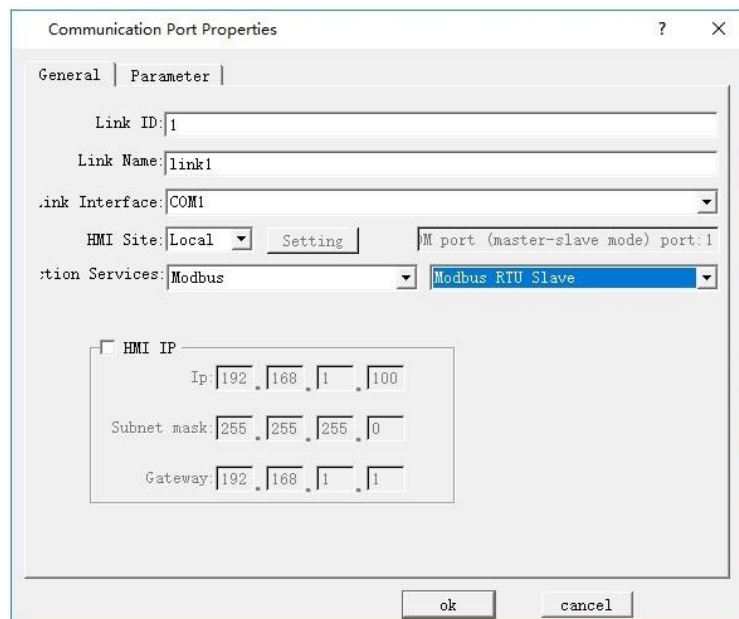

Figure 8-2 Choose MODBUS protocol, and set it as Slave Station

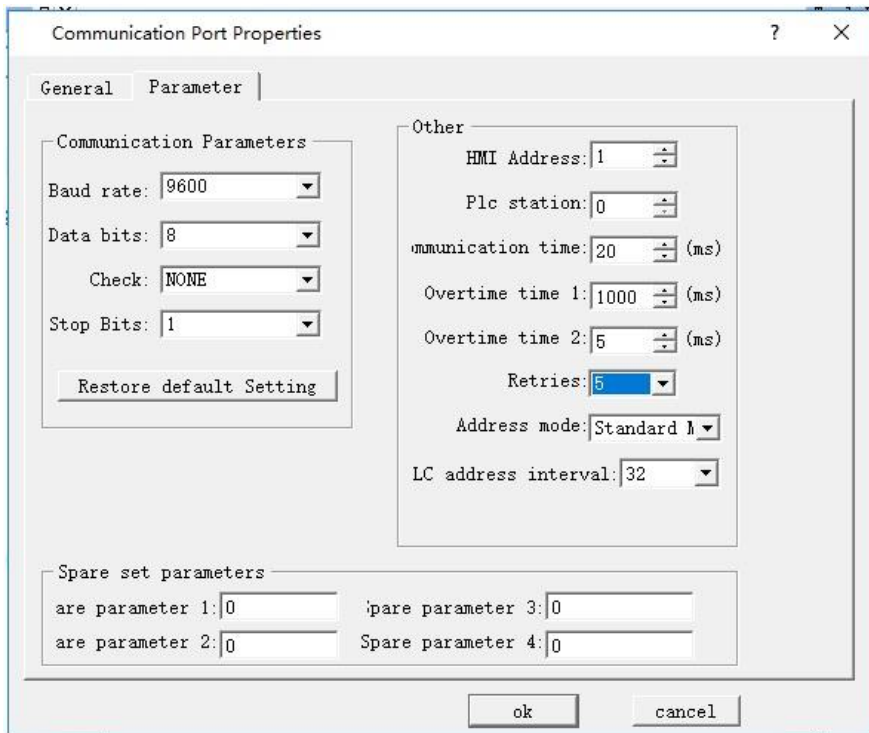

Figure 8-3 Allocation station address of HMI

2. The communication port of the PLC connected is RS485, connection method is as shown in Figure 8-4:

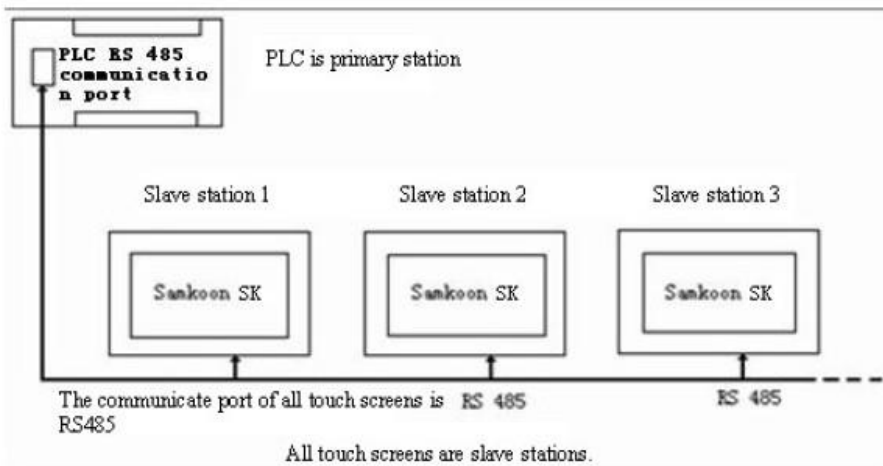

Figure 8-4 Sketch map of “One machine with multiple machines” when PLC(RS485) is Master station

When the communication port of PLC is RS485, as all touch screens are Slave Station, the system settings are the same as those when the communication port is RS232. Refer to Figure 8-2 and Figure 8-3.

When all HMI series screens are set as Slave Station, up to 255 screens may be connected. However, if many touch screens are connected, the response will be slow.

When the first touch screen is set as Master Station, and the PLC and all other screens are set as Slave Station:

1.The communication port of the PLC connected is RS232; connection methods and system settings are as shown in Figure 8-5, 8-6 and 8-7:

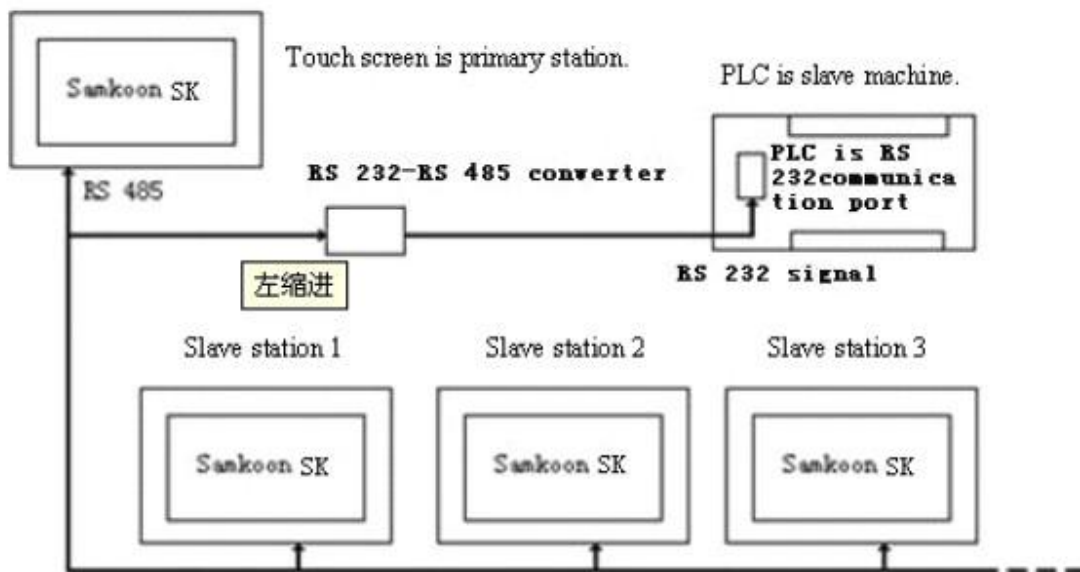

Following touch screens are slave stations with same communication port RS 485.

Figure 8-5 Sketch map of “One machine with multiple machines” when PLC (RS232) is Slave station



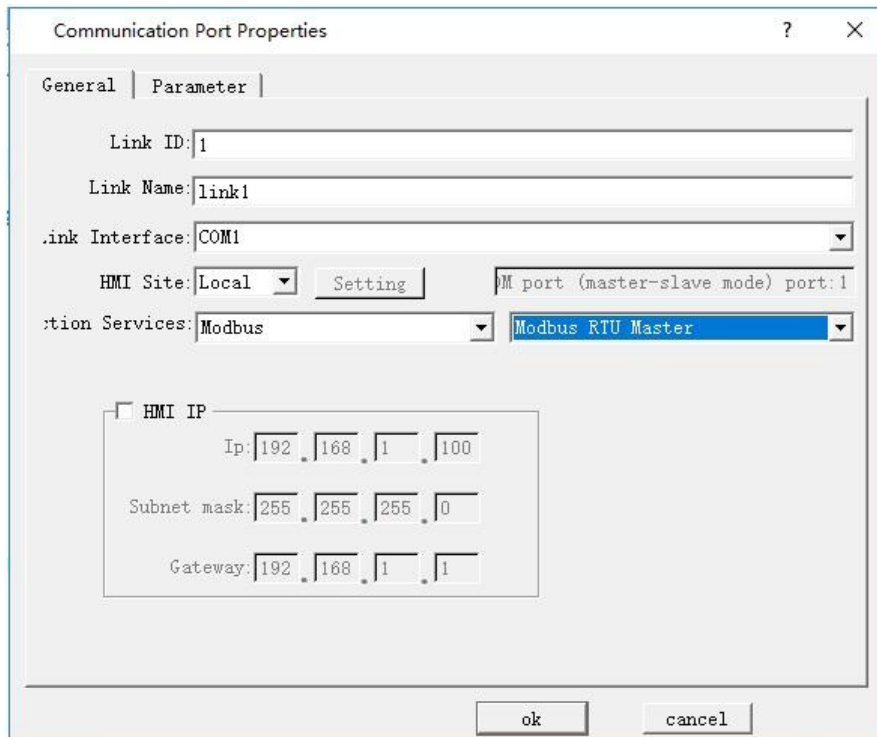

Figure 8-6 Choose MODBUS protocol for the first screen and set it as Master Station

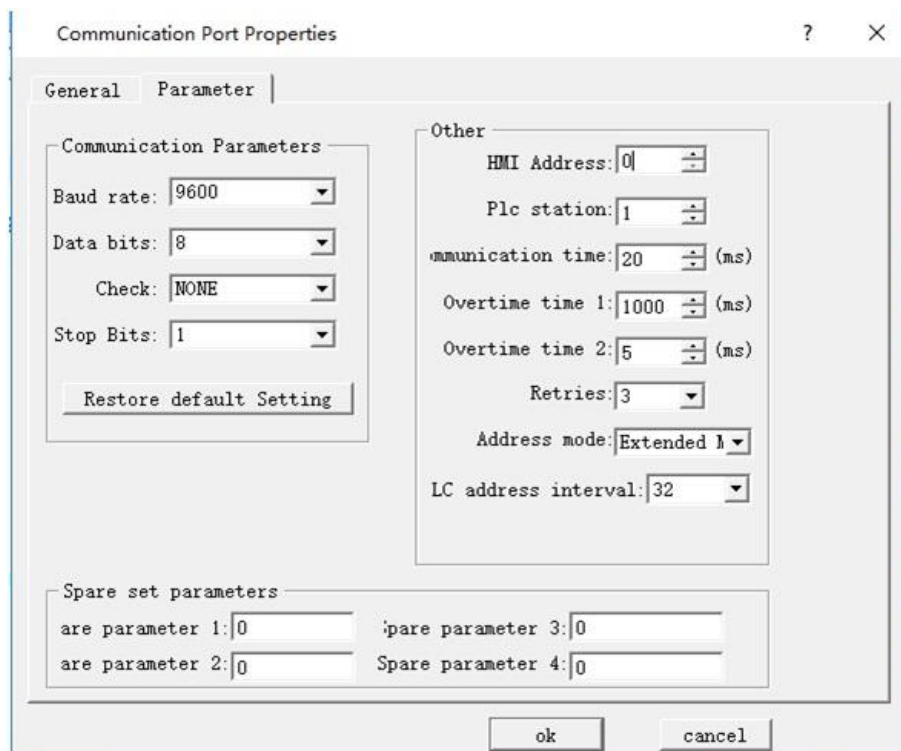

Figure 8-7 Extended are required when the first touch screen is set as Master Station

System setting of the touch screens set as slave station is similar as those shown in Figure 8-2 and

---

Figure 8-3.



Note: As RS232 cannot support multi-drop connection, when the PLC in the “one machine with multiple screens” connection does not support RS485 port, a communication adapter is required to convert RS485 signal to RS232 signal.

Note: When HMI series touch screen is set as master station in the “one machine with multiple screens” connection, multiple protocols must be set for the address mode of the touch screen used as master station.

When set Modbus as Master station, it can add up to 255 Slave stations in principle; however, the more slave stations are set, the slower communication speed will be.

## 11.2 “One screen with multiple machines” connection



HMI series allows not only “one machine with multiple screens” connection but also “one screen with multiple machines” connection for PLC via MODBUS protocol. In “one screen with multiple machines” connection, one touch screen may be used to directly operate the register address of several PLCs connected with it, so long as the PLCs support MODBUS protocol. At the time of system setting, choose Modbus RTU in Equipment Service item of General option and choose Modbus RTU Master on the right, so that the touch screen is set as Master Station and all PLCs are set as Slave Screens. Then, the touch screen may operate the register address of the PLCs. The register names of the PLCs correspond to the register names in MODBUS protocol.

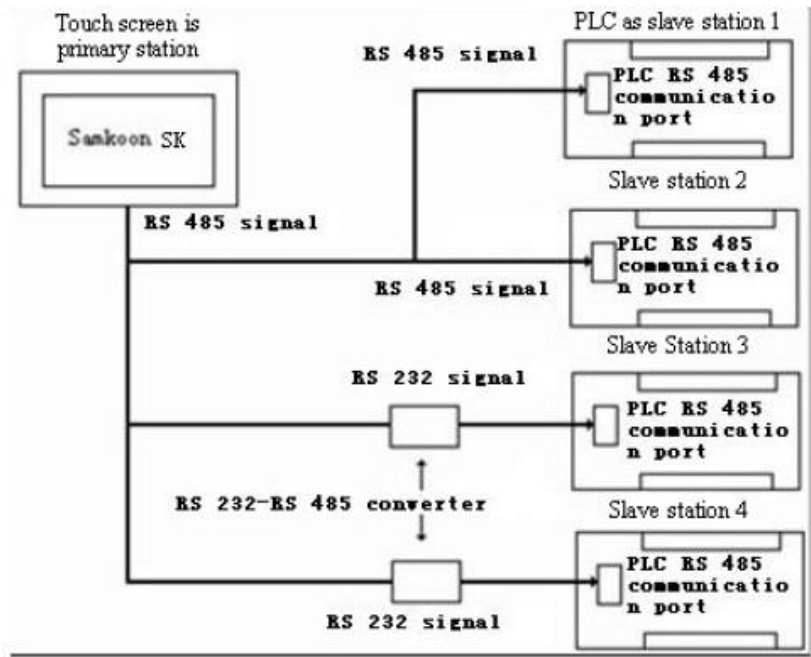

Figure 8-8 “One screen with multiple machines” connection

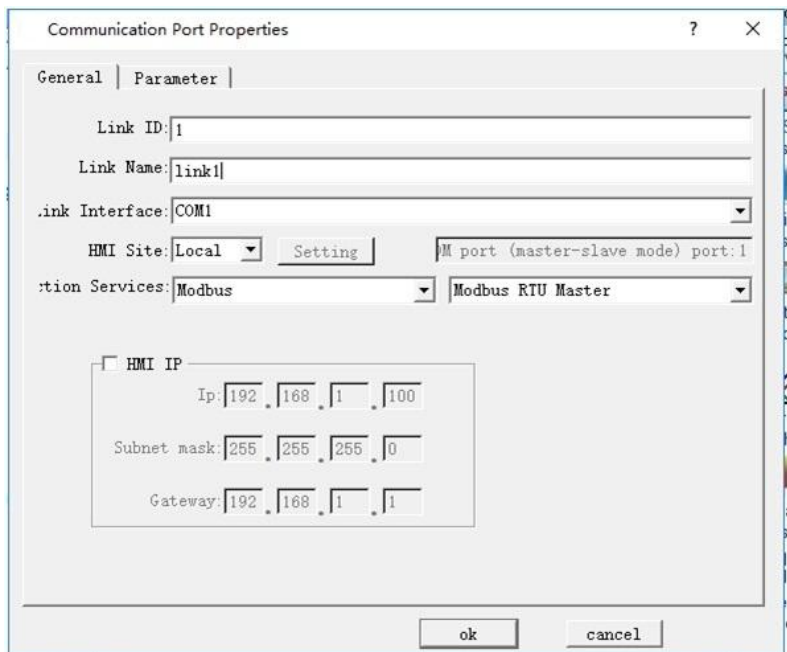

Figure 8-9 Set the touch screen as Master Station

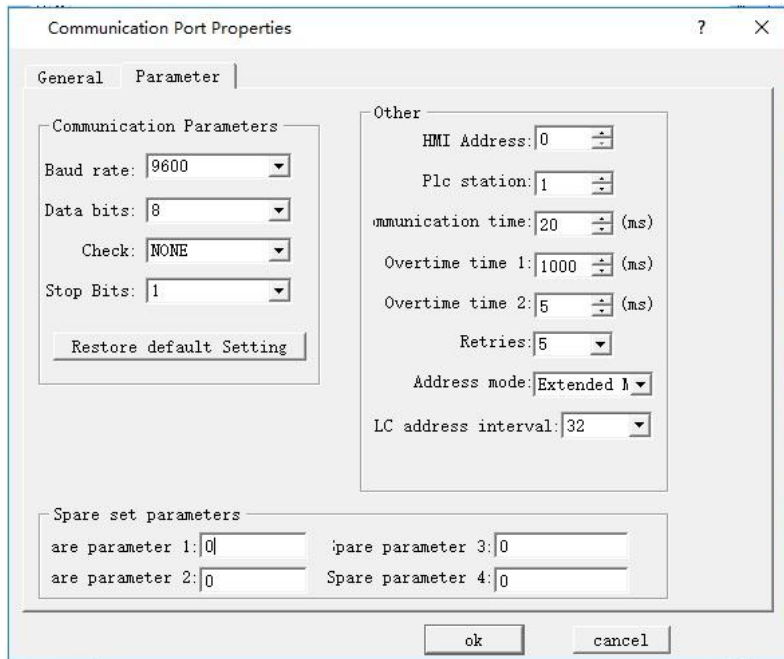

Figure 8-10 Extended Mode are required when the touch screen is set as Master Station

After above setting, the PLC addresses in the communication port attributes become ineffective. When user clicks a control to input address, an address input box as shown in Figure 8-11 will pop up. There is a dropdown menu on the right of the register name, and the protocol chosen from the dropdown menu is the Slave Station address of the PLC.

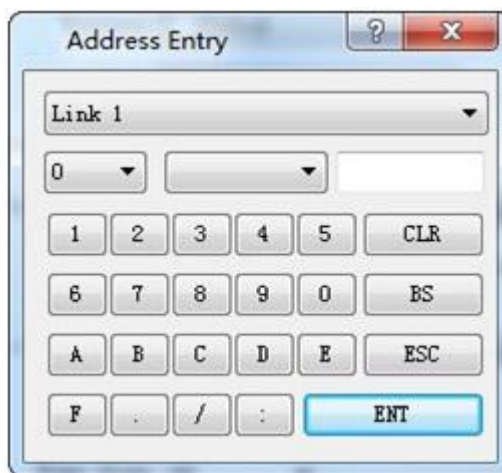

Figure 8-11 Address input box



---

#### **Instruction of extended mode stations enabling communication to control address:**

The address correspondence relation occupied by the control station number is 16 words corresponding to a serial port, that is, the maximum number of control enabling stations is 256, with LW59000 as the base address

COM1 corresponds to 59010~59025, LW59010 to station number 0~15, LW59011 to station number 16~31, and so on

COM2 corresponds to: 59026~59041, LW59026 corresponds to station number 0~15, LW59027 corresponds to station number 16~31, and so on

Ethernet correspondence: 59026~59041, LW59026 corresponds to station number 0~15, LW59027 corresponds to station number 16~31, and so on

The default is all on when HMI is open, you can use macro controlling every bit to start or stop connect station number.



Note: As RS232 cannot support multi-drop connection, when the PLC in the “one screen with multiple machines” connection does not support RS485 port, a communication adapter is required to convert RS485 signal to RS232 signal.

### **11.3 Penetration connection**



HMI touch screen allows a special connection manner, in which a remote HMI can monitor or control PLC or other devices via the serial port of another HMI connected with the PLC or device. In this case, there are two or more control terminals to operate the device connected. Penetration connection is a very useful function of HMI.

Before use penetration connection, the following terms should be understood:

- Local HMI: The HMI connected with the PLC or other device.

- Remote HMI: The HMI connected with the local machine that controls the devices connected through penetration.

To realize penetration connection, the local HMI must have two serial ports. The sketch map of penetration connection is shown in Figure 8-12 and Figure 8-13:

Penetration connection involving two screens:

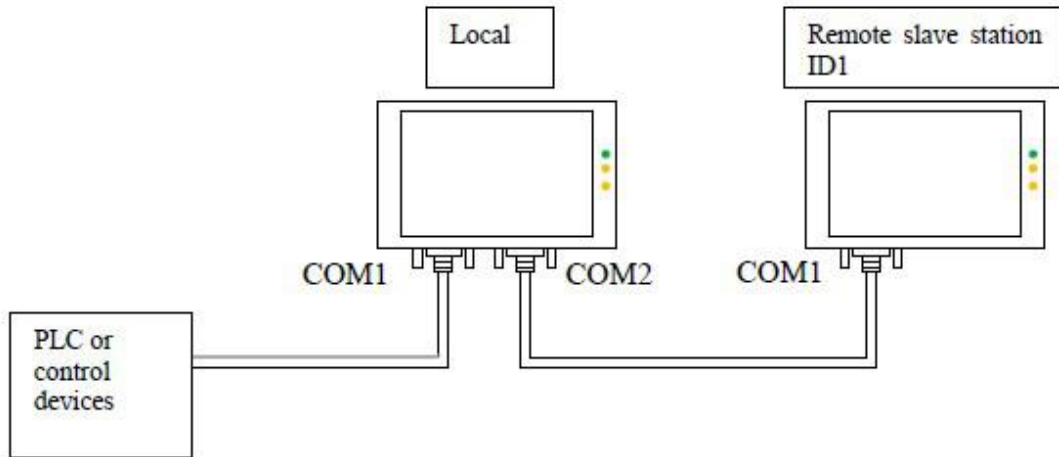

Figure 8-12 Sketch map of penetration connection involving two screens

Penetration connection involving multiple screens:

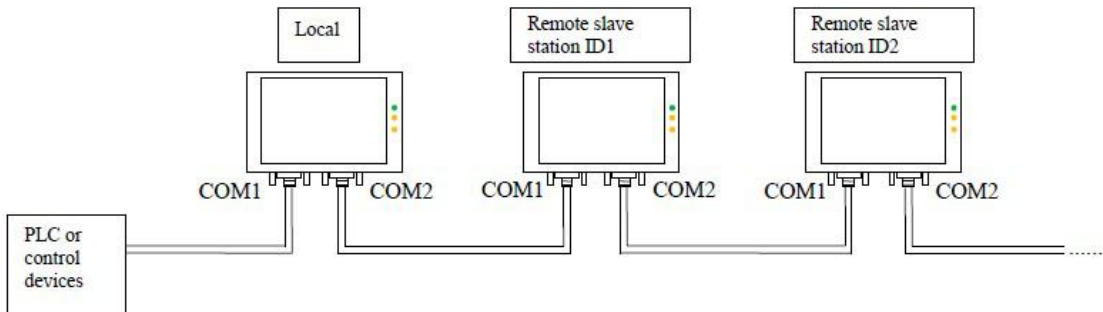

Figure 8-13 Sketch map of penetration connection involving multiple screens

Local HMI: Software setting:

Double click the connection established, and then a communication port attribute-setting box will pop up. Choose COM1 for connection port. Taking MITSUBISHI penetration for example, the COM1 of the local HMI is connected with MITSUBISHI FX2N PLC. The communication parameters set in Communication Parameter should be consistent with the PLC or other devices connected. See Figure 8-14 and Figure 8-15:

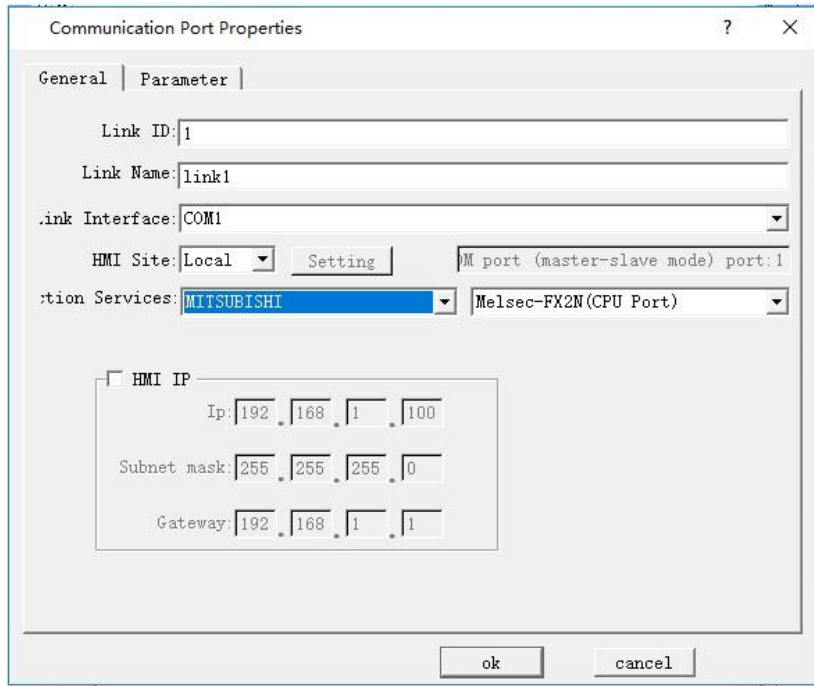

Figure 8-14 General page of local HMI communication port attribute setting

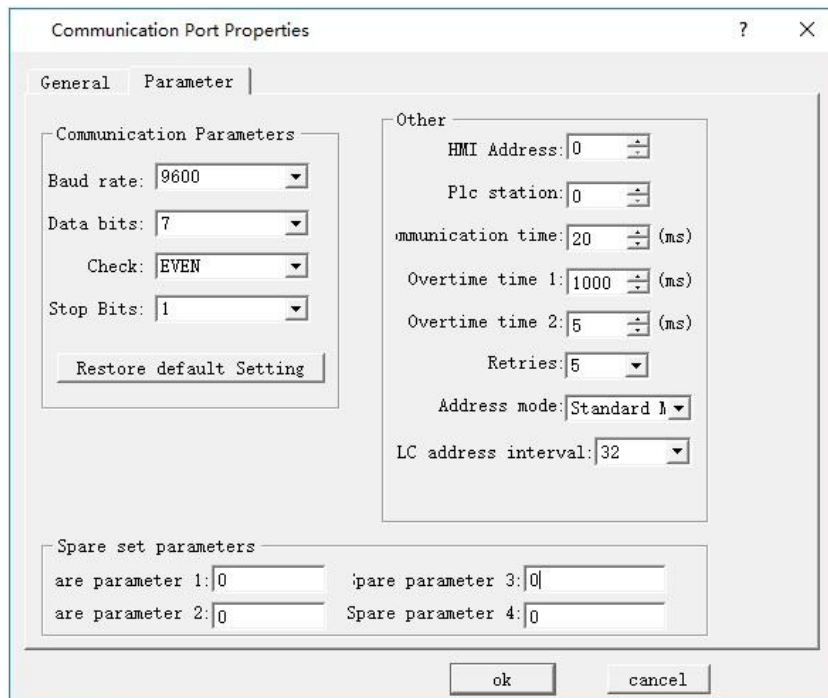

Figure 8-15: COM1 setting page of local HMI communication port attribute setting

Create a new connection, choose COM2 for the connection port, add no protocol in Connection, set attributes as follows, and set the same serial port attributes as serial port 1. The recommended parameters are 9600, 8, None, 1. Choose Connect Slave Screen Port for penetration attribute, and set the number of screens according to actual condition. See Figure 8-16 and Figure 8-17.

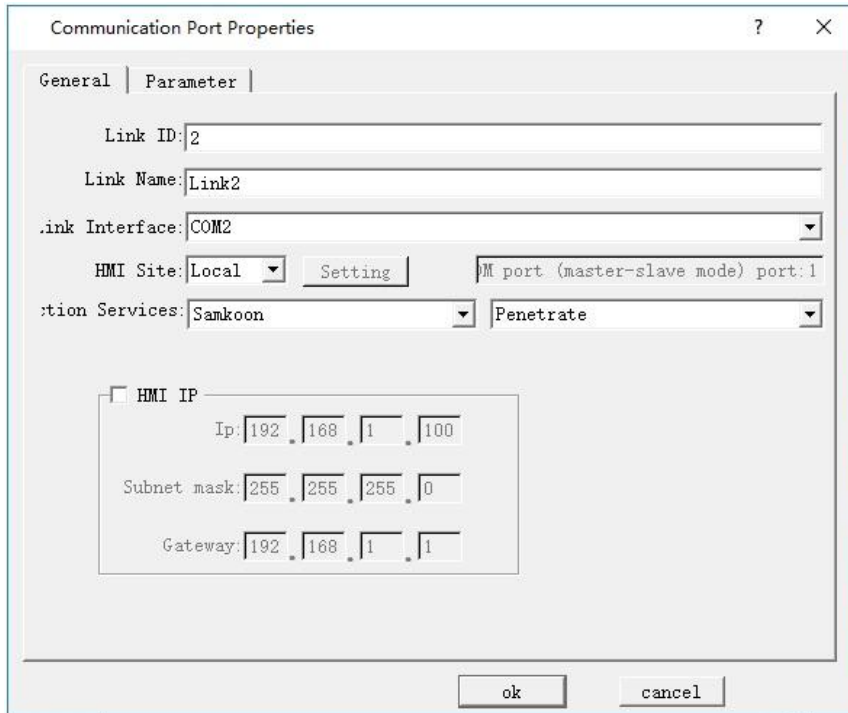

Figure 8-16 General page of local HMI communication port attribute setting

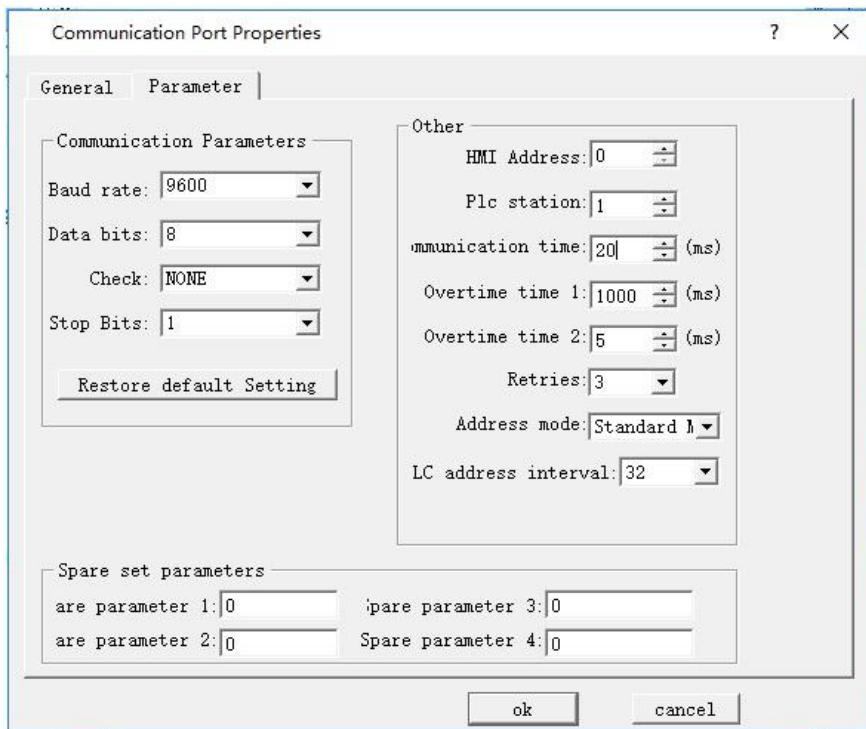

Figure 8-17 Parameter setting page of local HMI communication port attribute setting

Choose default values for other parameters. At this moment, the parameter setting for local HMI is completed.



Remote HMI: Software setting:

Double click the connection established, and then a communication port attribute-setting box will pop up. Choose COM1 for connection port, choose Remote for HMI Site, and set the same communication parameters as those in the COM2 parameter setting page of local HMI communication port attribute setting (as shown in Figure 6 above), as shown in Figure 8-18 and Figure 8-19.

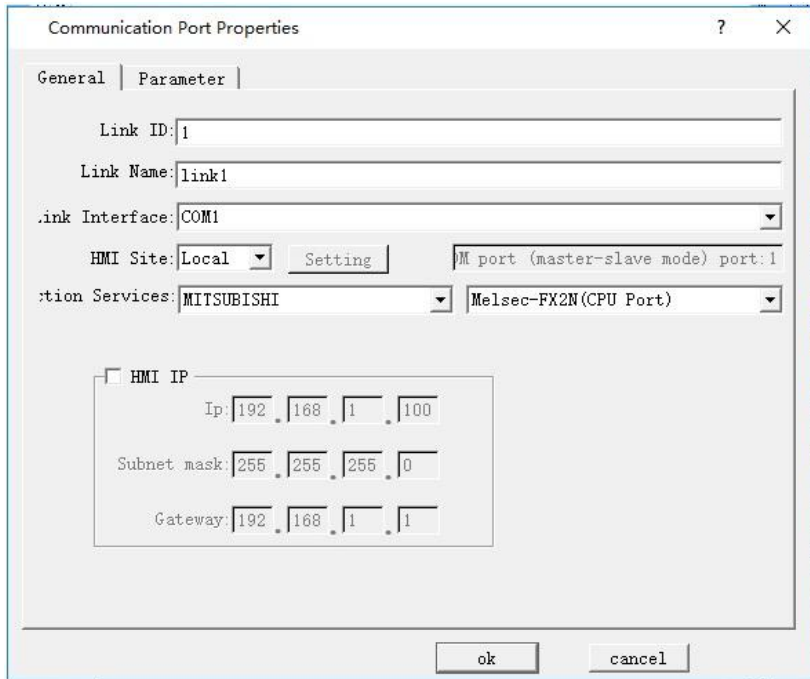

Figure 8-18 General page of remote HMI communication port attribute setting

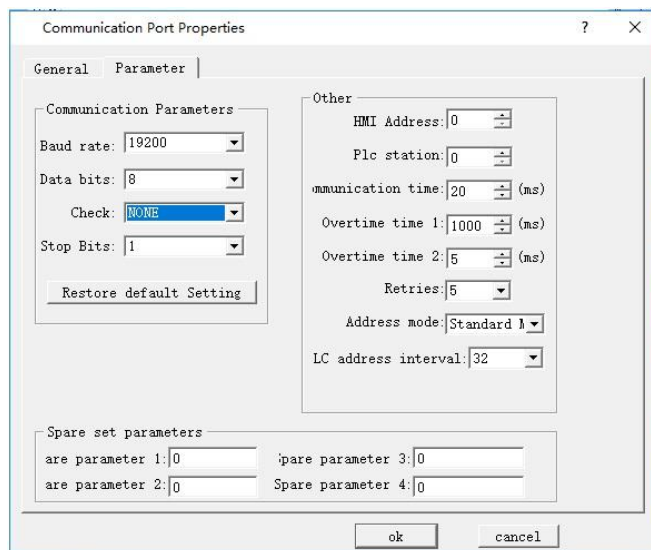

Figure 8-19 Parameter setting page of remote HMI communication port attribute setting

---

Choose default values for other parameters. At this moment, the parameter setting for remote HMI is completed.



Note: The above settings are software setting for penetration involving two screens.

Note: In penetration connection involving multiple screens, COM setting in remote HMI is the same as COM setting in local HMI.

Note: As all communication data are exchanged with PLC through COM1 of local HMI, the communication rate will be low in the case of penetration connection involving multiple screens.

## 11.4 Modbus TCP/IP



It is available to execute remote communication and control to HMI through the MODBUS TCP.

**Settings** when set HMI as Master station:

Double click "Connection 1" after creating a project, as shown below:

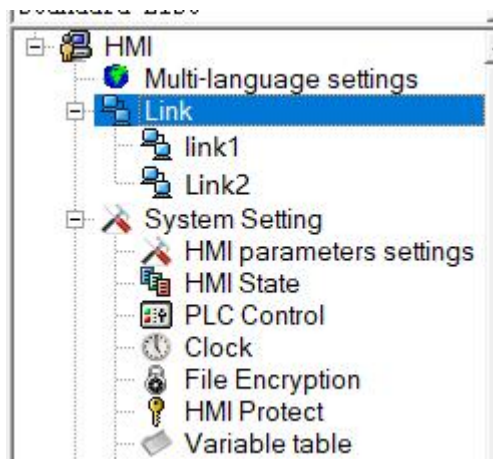

The "Communication Port Properties" dialog box is displayed (shown below).

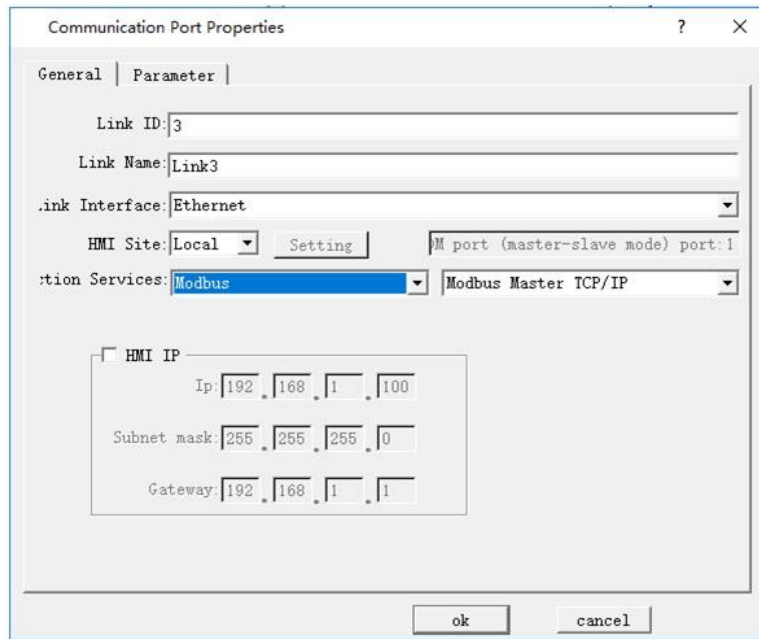

Click "Parameter" in the pop-up "Port Properties" dialog box, enter the following dialog box to set the IP address and the port number (IP address and port are those of monitoring device). Choose standard address mode; Click "OK" to complete the settings.

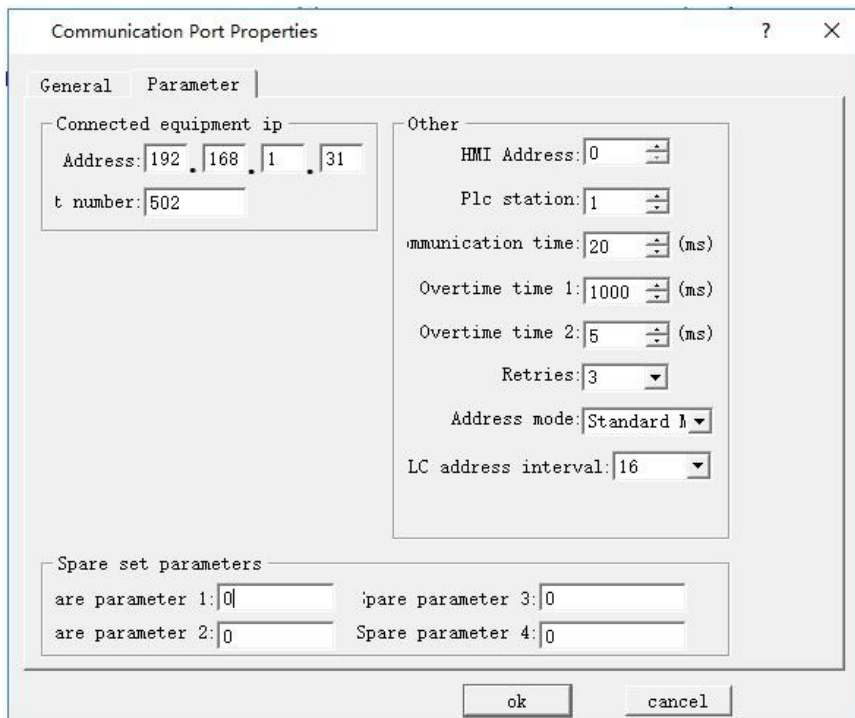

If select "Extended Mode" for Address Mode, settings of IP address and port number here are invalid, while they can be set via the function button "Slave devices IP config" in the configuration.

During the configuration runtime, click the button to pop up the window for inputting the station

number; input the station number, and then enter into the interface for setting the slave IP and port number, as shown in the following figure:

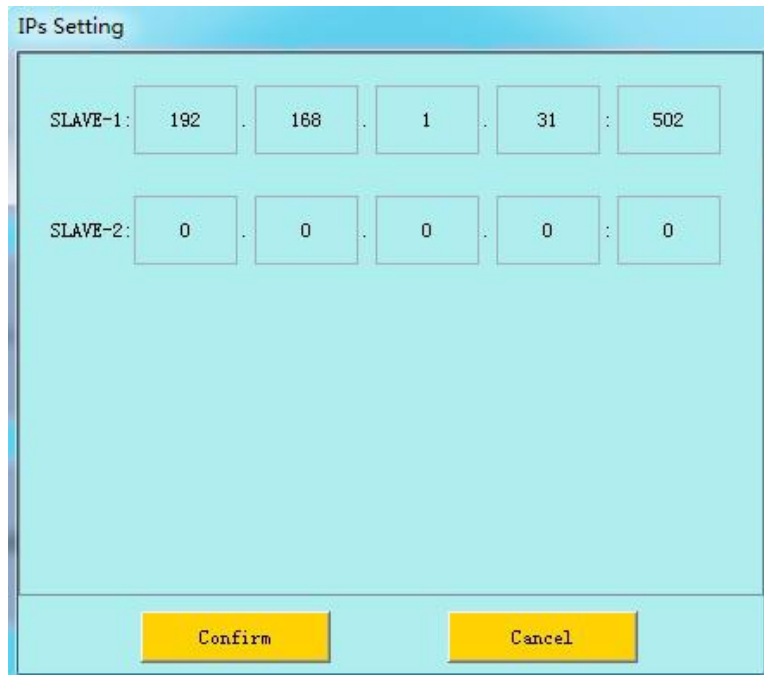

After the above settings, download the project into HMI; connect the master and slave station directly or through a router in order to perform operations of monitoring and control.

**Settings of slave station:**

**1. Set the IP**

First, use DIAL switches 1, 3 to set the IP address of HMI; in the pop-up IP setting interface, enter the IP address. In this example, set the IP address of slave station to 192.168.1.31. 2.

**2. Establish connections**

After creating the project, double click "Connection 1" in the following picture, as shown below:

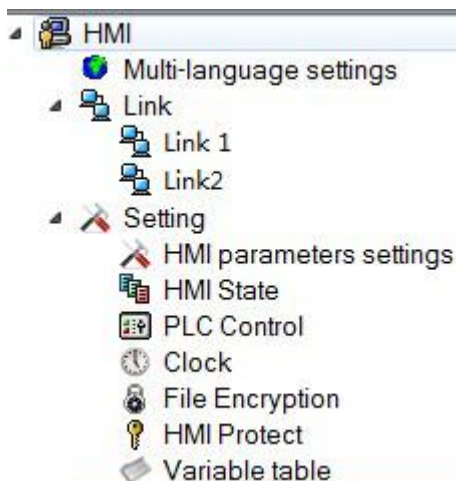

The "Communication Port Properties" dialog box is displayed (shown below).

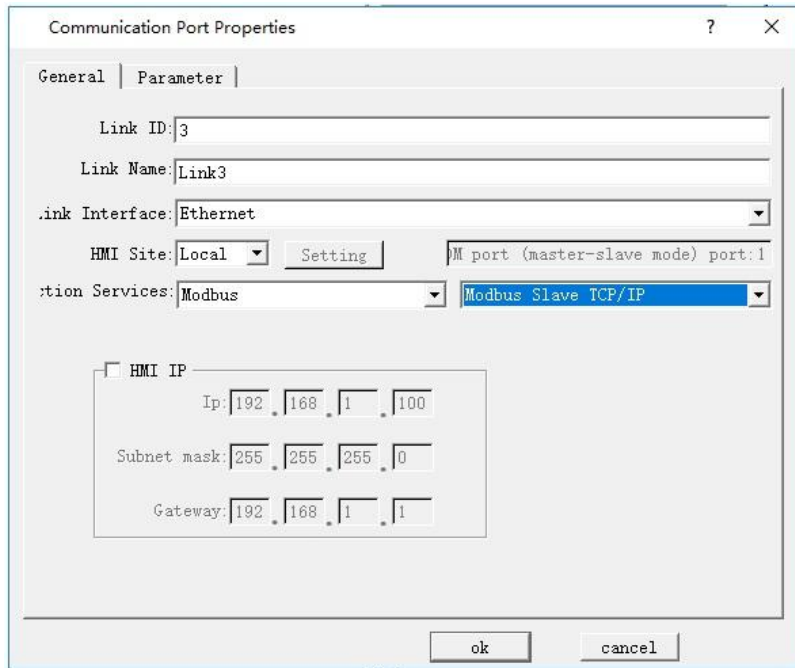

In the dialog box shown above, execute the following settings:

\* Connection Port: "Ethernet" (as shown).

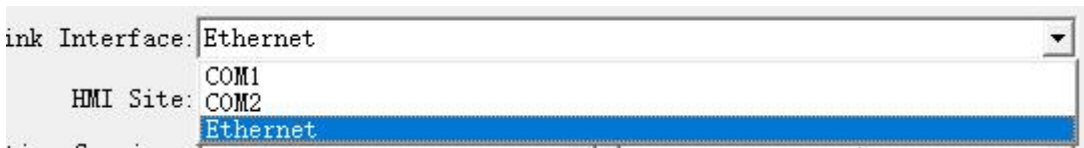

\* HMI Site: Select "Local" (as shown).



\* Connection Service: Select "Modbus" - "Modbus Slave TCP / IP" (as shown).



Click "Parameter" in the pop-up "Port Properties" dialog box, enter the following dialog box to set the IP address (IP address of the slave station) and the port number. Click "OK" to complete the settings.

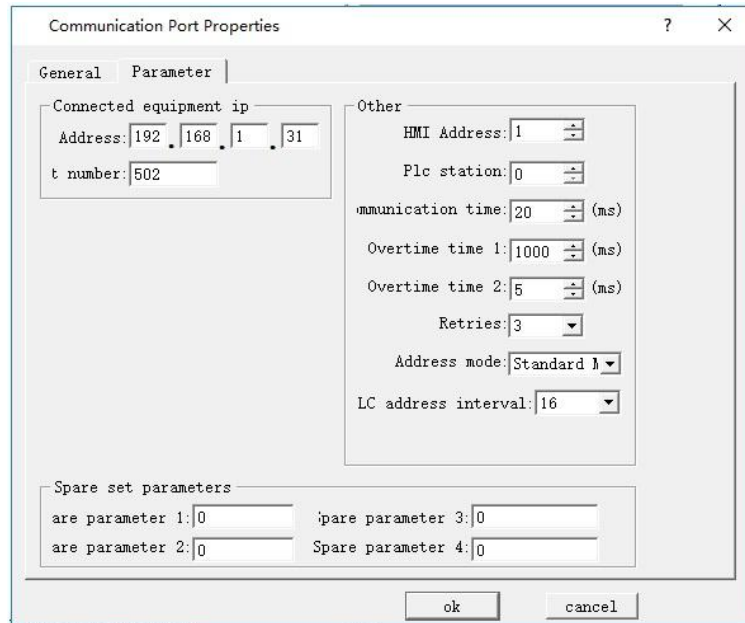

Download the project into HMI; connect the master and slave station directly or through a router in order to perform operations of monitoring and control.



Address is the internal address when HMI is set as slave station.

---

## 12. Device driver



---

This chapter details connected devices compatible with the SK series HMI of Shenzhen Samkoon Technology Co., Ltd.

It is important for the configuration to set I / O of device driver. SK series HMI can communicate with PLC, MCU, inverter and other industrial equipment, including the vast majority of PLCs: SAMKOON, MITSUBISHI, OMRON, SIEMENS, ALLEN-BRADLEY Rockwell, MATSUSHITA, DELTA, FATEK, etc. Or it can also monitor and control certain industrial control equipment via specific protocol, such as MODBUS RTU / ASCII, HOSTLINK and some other custom protocols.

I / O driver of each PLC or device is made into a file, so it only needs to select the corresponding PLC or device when creating a configuration project without the necessity for engineers to perform other complex programming operation. SKTOOL is the configuration software of SK series HMI, which can realize functions of all kinds of registers or relays of most PLCs or devices through simple and convenient configuration operations. There are three operation modes: read only, write only, read and write, meeting various requirements of industrial control.

To facilitate connections to different devices, Shenzhen Samkoon Technology Co., Ltd launches the service of developing device-driven according to the needs of users, simply with need of an appropriate protocol document of corresponding communication device. Users can contact Shenzhen Samkoon Technology Co., Ltd. via the contact information provided at the end of this manual.

PLCs supported by SK Series HMI:

| Manufacturer<br>(Brand)      | Model                | Communication<br>Protocol  | Connection<br>Mode                 |
|------------------------------|----------------------|----------------------------|------------------------------------|
| Samkoon                      | FGs series           | User-defined<br>protocol   | Direct connection<br>(Serial port) |
| Advantech<br>Distributed I/O | ADAM-4017, ADAM-4060 | Proprietary<br>protocol of | Direct connection<br>(Serial port) |

|  |                   |   |                                    |
|--|-------------------|---|------------------------------------|
|  |                   | Advantech                                 |                                    |
| <a href="#">AIBUS</a>                              | AI series         | AIBUS protocol                            | Direct connection<br>(Serial port) |
| <a href="#">Allen-Bradley</a>                      | MicroLogix series | DF1 protocol                              | Direct connection<br>(Serial port) |
| Altec Electronics                                  | AL series         | Proprietary<br>protocol of Altec          | Direct connection<br>(Serial port) |
| <a href="#">Can_communication</a>                  | Can               | Can                                       | Direct connection<br>(Serial port) |
| <a href="#">Delta Corporation</a>                  | DVP series        | Proprietary<br>protocol of Delta          | Direct connection<br>(Serial port) |
| <a href="#">Emerson Network<br/>Power</a>          | EC series         | Proprietary<br>protocol of<br>Emerson     | Direct connection<br>(Serial port) |
| <a href="#">Fatek Automation<br/>Corporation</a>   | FB series         | Proprietary<br>protocol of Fatek          | Direct connection<br>(Serial port) |
| <a href="#">Fuji Electric<br/>Corporation</a>      | NB series         | Proprietary<br>protocol of Fuji           | Direct connection<br>(Serial port) |
| <a href="#">GE Corporation</a>                     | GE SNP-X/CCM      | Proprietary<br>protocol of GE             | Direct connection<br>(Serial port) |
| <a href="#">Haiwell Technology<br/>Corporation</a> | E/S/H series      | Proprietary<br>protocol of<br>Corporation | Direct connection<br>(Serial port) |
| <a href="#">Hitachi Industrial</a>                 | E/EH series       | Proprietary<br>protocol of Hitachi        | Direct connection<br>(Serial port) |
| <a href="#">HollySys Group</a>                     | LM series         | Proprietary<br>protocol of HollySys       | Direct connection<br>(Serial port) |
| <a href="#">IDEC Corporation</a>                   | FC4A/FC5A series  | Proprietary<br>protocol of IDEC           | Direct connection<br>(Serial port) |



|                                       |   |  |  |
|---------------------------------------|---|--|--|
| Inovance<br>Technology<br>Corporation | H1u/H2u series                                    | Proprietary<br>protocol of<br>Inovance   | Direct connection<br>(Serial port)             |
| JiaChuang<br>Technology               | JiaChuang   | Proprietary<br>protocol of<br>JiaChuang  | Direct connection<br>(Serial port)             |
| KDN Automation<br>Corporation         | K3 series   | Proprietary<br>protocol of KDN           | Direct connection<br>(Serial port)             |
| Keyence<br>Corporation                | KV-1000/700 KV-L20(R),<br>KV-10/16/24/40 KV-P16   | Proprietary<br>protocol of<br>Keyence    | Direct connection<br>(Serial port)             |
| Koyo Electronics                      | SN series   | Proprietary<br>protocol of KoYo          | Direct connection<br>(Serial port)             |
| Kstar Technology                      | Kstar Equipment                                   | Proprietary<br>protocol of Kstar         | Direct connection<br>(Serial port)             |
| Letrun Technology                     | LC series   | Proprietary<br>protocol of Letrun        | Direct connection<br>(Serial port)             |
| LG Industrial<br>Systems              | Master-K series                                   | Proprietary<br>protocol of LG            | Direct connection<br>(Serial port)             |
| Matsushita                            | FP series   | Proprietary<br>protocol of<br>Matsushita | Direct connection<br>(Serial port)             |
| Mitsubishi                            | Melsec-FX/FX2N/FX3U/FX3G,<br>Melsec-Q_C24N series | Proprietary<br>protocol of<br>Mitsubishi | Direct connection<br>(Serial port)             |
| Modbus                                | RTU/ASCII Equipment, RTU<br>TCP/IP Equipment      | Modbus Protocol                          | Direct connection<br>(Serial<br>port/Ethernet) |
| Modicon                               | NEZA/TWIDO/M218 series                            | Modbus Protocol                          | Direct connection                              |

|                               |                                   |                                    |                                 |
|-------------------------------|-----------------------------------|------------------------------------|---------------------------------|
| Corporation                   |                                   |                                    | (Serial port)                   |
| Nanda Auto Technology         | NA-200/NA-400 series              | Proprietary protocol of Nanda Auto | Direct connection (Serial port) |
| Omron                         | C/CPM series, CS/CJ series        | Proprietary protocol of Omron      | Direct connection (Serial port) |
|                               |                                   |                                    |                                 |
| SEARI                         | VP series                         | Proprietary protocol of SEARI      | Direct connection (Serial port) |
| Shimaden                      | MR13                              | Proprietary protocol of Shimaden   | Direct connection (Serial port) |
| Siemens                       | S7-200(PPI), S7-300(MPI), S7-1200 | Proprietary protocol of Siemens    | Direct connection (Serial port) |
| TaiAn Technology              | TP03 series                       | Proprietary protocol of TaiAn      | Direct connection (Serial port) |
| TaiLing Electric              | DX series                         | Proprietary protocol of TaiLing    | Direct connection (Serial port) |
| Techwayson Technology         | V series                          | Proprietary protocol of Techwayson | Direct connection (Serial port) |
| Vigor Electric Corporation    | V/VH/VB/M series                  | Proprietary protocol of Vigor      | Direct connection (Serial port) |
| Xinje Electronic              | XC/XCM series                     | Proprietary protocol of XinJe      | Direct connection (Serial port) |
| Yokogawa Electric Corporation | FA-M3 series                      | Proprietary protocol of Yokogawa   | Direct connection (Serial port) |
| ZhengHang                     | A4/A5 series                      | Proprietary                        | Direct connection               |

|             |  |                          |               |
|-------------|--|--------------------------|---------------|
| Electronics |  | protocol of<br>ZhengHang | (Serial port) |
|-------------|--|--------------------------|---------------|

■ Pin definitions of SK series HMI COM1/COM2

SK HMI employs nine-pin plug so that it should be nine-pin receptacle for the connection cable. Pin definitions are shown below:

| SK HMI COM1/COM2 |     |
|------------------|-----|
| 1                |     |
| 2                | RX  |
| 3                | TX  |
| 4                | KZ  |
| 5                | GND |
| 6                | RX- |
| 7                | RX+ |
| 8                | TX- |
| 9                | TX+ |

■ RX: RS232 Receiver of communication

■ TX: RS232 Sender of communication

■ KZ: Control port

■ GND: Ground terminal

■ RX-: RS422 Communication receiving-

■ RX+: RS422 Communication receiving +

- TX-: RS422 Communication transporting -/RS485 Communication B
- TX+: RS422 Communication transporting +/RS485 Communication A

#### Note

- Terminals of 2/3/5 in case of RS232 communication ;
- Terminals of 6/7/8/9 in case of RS422 communication;
- Terminals of 8/9 in case of RS485 communication.

## 12.1 Samkoon device driver

The device driver is used for SK series HMI to read and write the data or state of Samkoon FGs series PLC. The serial communication connection is established through the serial port of the HMI and the serial port of Samkoon FGs series PLC, so as to operate Samkoon device. Prior to use of the driver, please carefully read this chapter and the related technical specifications of the Samkoon device.

How to establish connection with Siemens S7-200/300 series PLC

### 1. Hardware connection

Connecting cable:

RS232

| SK HMI COM1/COM2 |     | Samkoon FGs series |     |
|------------------|-----|--------------------|-----|
| 2                | RX  | 5                  | TX  |
| 3                | TX  | 4                  | RX  |
| 5                | GND | 3                  | GND |
|                  |     |                    |     |

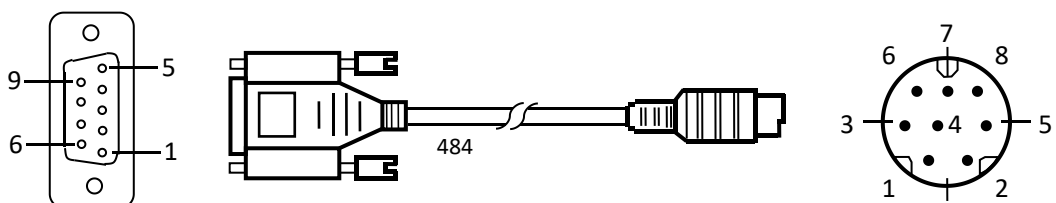

Terminal of SK series HMI is DB9F; that of Delta DVP series PLC is MD8M.

RS485

| SK HMI COM1/COM2 |     | Samkoon FGs series |
|------------------|-----|--------------------|
| 8                | TX- | B                  |
| 9                | TX+ | A                  |

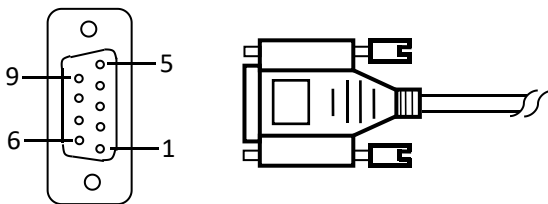

Terminal of SK HMI is DB9F, and that of Samkoon series PLC is two-wire terminal.

## 2. Software settings

Select Samkoon in connection device service.

Select the corresponding item in connection device service according to the connected PLC model or supported protocol.

Ensure that the communication parameters in touch screen connection parameters and PLC station number are consistent with the PLC connected.

For settings of the PLC, refer to the technical documents of the Samkoon series PLC.

Default connection parameters of SK series HMI

| Setting item            | Default parameter value | Setting scope                      |
|-------------------------|-------------------------|------------------------------------|
| PLC type                | FGs Series (RTU)        | FGs Series (RTU)/SamFGS            |
| Communication port type | RS232                   | RS232/ RS485                       |
| Baud rate               | 9600                    | 4800/9600/19200/38400/57600/115200 |
| Data bit length         | 8                       | 8                                  |

|                    |      |               |
|--------------------|------|---------------|
| Parity bit         | NONE | EVEN/ODD/NONE |
| Stop bit length    | 1    | 1/2           |
| PLC station number | 1    | 0~255         |
| HMI station number | 0    | 0~255         |

| Supporting function | Whether it is supported |
|---------------------|-------------------------|
| Off-line simulation | yes                     |
| On-line simulation  | yes                     |
| Extended mode       | yes                     |

### 3. Operational register and address range

FGs Series (RTU)/SamFGS

| Register name | Address format | Input range        | Remarks   |
|---------------|----------------|--------------------|---|
| X             | ooo            | 0~127<br>1000~2777 | Bit: input connection point, read only<br>1000~2777(Extension module) |
| Y             | ooo            | 0~127<br>1000~2777 | Bit: output connection point<br>1000~2777(Extension module)           |
| M             | dddd           | 0~8191             | Bit: internal relay   |
| T             | ddd            | 0~255              | Bit: timer status   |
| C             | ddd            | 0~255              | Bit: counter status   |
| S             | ddd            | 0~999              | Bit: stepping relay   |

|      |      |         |                                       |
|------|------|---------|---------------------------------------|
| D    | dddd | 0~8191  | Word: temporary data storage          |
| TV   | ddd  | 0~255   | Word: current value of timer          |
| CV   | ddd  | 0~199   | Word: current value of counter        |
| V    | d    | 0~7     | Word: indexed addressing register     |
| Z    | d    | 0~7     | Word: indexed addressing register     |
| AI   |      | 0~31    | Word: analog input                    |
|      | dd   | 100~379 | 100~379(Extension module)             |
| AO   |      | 0~31    | Word: analog output                   |
|      | dd   | 100~379 | 100~379(Extension module)             |
| 32CV | ddd  | 200~255 | Double Word: current value of counter |

Note:

d represents decimal system, input range is 0-9;

o represents octal system, input range is 0-7;

Word in the remarks: represents the register can only be used as word;

Double-word in the remarks: represents that the data type of the register in configuration must be 32-bit;

Bit in the remarks: represents the register can only be used as bit;

Read only in the remarks represents that the register can only be read but not be written;

The names of the registers supported by different equipment model may be different, and the scopes may also be different.

For detailed name and scope, please consult related technical document of the connected device

## 12.2 AIBUS device driver

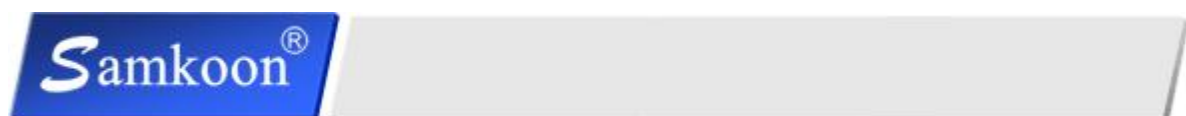

The device driver is used for SK series HMI to read and write the data or state of AIBUS device via AIBUS protocols. The serial communication connection is established through the serial port of the HMI and the serial port of AIBUS device, so as to operate AIBUS device. Prior to use of the driver, please carefully read this chapter and the related technical specifications of the AIBUS device.

### 1. Hardware connection

Connecting cable:

RS232 (serial port RS232 protocol)

| SK HMI COM1/COM2 |     | AIBUS device      |     |
|------------------|-----|-------------------|-----|
| 2                | RX  | User-defined pins | TX  |
| 3                | TX  | User-defined pins | RX  |
| 5                | GND | User-defined pins | GND |

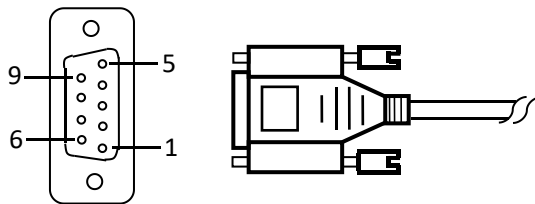

HMI series touch screen port is a 9P trapezoidal female connector. Definitions of AIBUS device pins depend on particular AIBUS device.

### RS422 (Serial port RS422 protocol)

| SK HMI COM1/COM2 |     | AIBUS device      |     |
|------------------|-----|-------------------|-----|
| 6                | RX- | User-defined pins | TX- |
| 7                | RX+ | User-defined pins | TX+ |
| 8                | TX- | User-defined pins | RX- |
| 9                | TX+ | User-defined pins | RX+ |

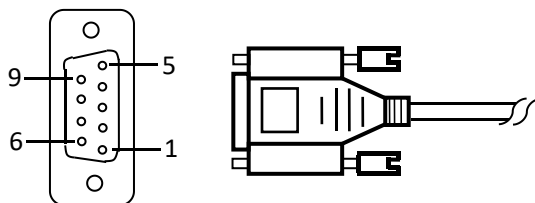

HMI series touch screen port is a 9P trapezoidal female connector. Definitions of AIBUS device pins depend on particular AIBUS device.

### RS485 (Serial port RS485 protocol)

| HMI series touch screen COM1/COM2 |    | AIBUS device      |   |
|-----------------------------------|----|-------------------|---|
| 8                                 | D- | User-defined pins | B |
| 9                                 | D+ | User-defined pins | A |

HMI series touch screen port is a 9P trapezoidal female connector. Definitions of AIBUS device



pins depend on particular AIBUS device.

## 2. Software settings

Select AIBUS Protocol in connection device service.

Select the corresponding item in connection device service according to the connected PLC model or supported protocol.

Ensure that the communication parameters in touch screen connection parameters and PLC station number are consistent with the AIBUS device.

For settings of the AIBUS device, refer to the technical documents of the AIBUS device.

Default connection parameters of HMI series touch screen

| Setting item            | Default parameter value | Setting scope                                |
|-------------------------|-------------------------|--|
| PLC type                | AIBUS Protocol          | AIBUS Protocol                               |
| Communication port type | RS232                   | RS232/RS422/RS485                            |
| Baud rate               | 9600                    | 1200/2400/4800/9600/19200/38400/57600/115200 |
| Data bit length         | 8                       | 7/8  |
| Parity bit              | NONE                    | EVEN/ODD/NONE                                |
| Stop bit length         | 1                       | 1/2  |
| PLC station number      | 1                       | 1~255  |
| HMI station number      | 0                       | 0~255  |

| Supporting function | Whether it is supported |
|---------------------|-------------------------|
| Off-line simulation | Yes                     |
| On-line simulation  | Yes                     |
| Extended mode       | Yes                     |

## 3. Operational register and address range

| Register name | Address format | Input range | Remarks              |
|---------------|----------------|-------------|----------------------|
| Parameter     | ddd            | 0~255       | Word: parameter item |
| PV            | d              | 0           | Word: Output value   |
| SV            | d              | 0           | Word: Set value      |
| MV            | d              | 0           | Word: State value    |
| Status        | d              | 0           | Word: State value    |

Note:

- d represents decimal system, input range is 0-9;
- "Word" in the remarks: represents that the register can only be used as word;
- The names of the registers supported by different equipment model may be different, and the scopes may also be different.

For detailed name and scope, please consult related technical document of the connected device.

## 12.3 Allen-Bradley device driver

The device driver is used for SK series HMI to read and write the data or state of AIBUS device via AIBUS protocols. The serial communication connection is established through the serial port of the HMI and the serial port of AIBUS device, so as to operate AIBUS device. Prior to use of the driver, please carefully read this chapter and the related technical specifications of the AIBUS device.

### How to establish connection with AIBUS device

#### 1. Hardware connection

Connecting cable:

RS232 (serial port RS232 protocol)

| SK HMI COM1/COM2 |     | AIBUS device      |     |
|------------------|-----|-------------------|-----|
| 2                | RX  | User-defined pins | TX  |
| 3                | TX  | User-defined pins | RX  |
| 5                | GND | User-defined pins | GND |

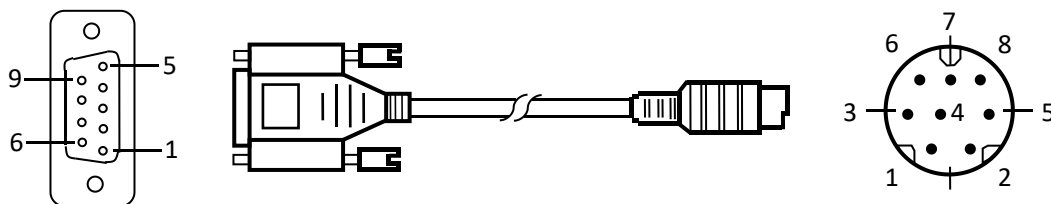

ControlLogix/CompactLogix:

| SK HMI COM1/COM2 |     | Allen-Bradley (AB) |     |
|------------------|-----|--------------------|-----|
| 2                | RX  | 3                  | TX  |
| 3                | TX  | 2                  | RX  |
| 5                | GND | 5                  | GND |

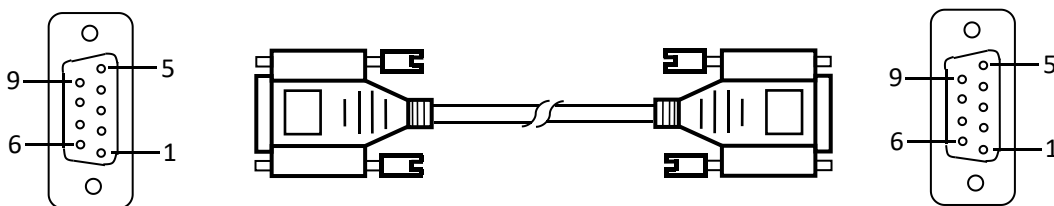

SK HMI port is DB9F, and AB device port is MD8M.

## 2. Software settings

Select Allen-Bradley in connection device service.

Select the corresponding item in connection device service according to the connected PLC model or supported protocol.

Ensure that the communication parameters in touch screen connection parameters and PLC station number are consistent with the PLC connected.

For settings of the PLC connected device, refer to the technical documents of the Allen-Bradley PLC.

Default connection parameters of SK HMI

| Setting item            | Default parameter value | Setting scope                                |
|-------------------------|-------------------------|--|
| PLC type                | MicroLogix DF1_CRC      | MicroLogix DF1_CRC/MicroLogix DF1_BCC        |
| Communication port type | RS232                   | RS232/RS422/RS485                            |
| Baud rate               | 19200                   | 1200/2400/4800/9600/19200/38400/57600/115200 |
| Data bit length         | 8                       | 7/8  |
| Parity bit              | NONE                    | EVEN/ODD/NONE                                |
| Stop bit length         | 1                       | 1/2  |
| PLC station number      | 1                       | 1~31   |
| HMI station number      | 0                       | 0~255  |
| Check                   | CRC                     | BCC  |

| Supporting function | Whether it is supported |
|---------------------|-------------------------|
| Off-line simulation | Yes                     |
| On-line simulation  | Yes                     |
| Extended mode       | No                      |

## 3. Operational register and address range

SLC

series/MicroLogix:

| Register name | Address format | Input range           | Remarks                        |
|---------------|----------------|-----------------------|--------------------------------|
| I             | 1:ddd/o        | 1:0/0~1:255/15        | Bit: input shadow register     |
| O             | 0:ddd/o        | 0:0/0~0:255/15        | Bit: output shadow register    |
| B             | ddd:ddd/o      | 3:0/0~255:255/15      | Bit: bit memory                |
| S_Bit         | 2:ddd/o        | 2:0/0~2:255/15        | Bit: System state bit          |
| N_Bit         | ddd:ddd/o      | 7:0、10:0/0~255:255/15 | Bit: Bit of data register word |

|       |            |                  |                                |
|-------|------------|------------------|--------------------------------|
| S     | 2:ddd      | 2:0~2:255        | Word: System state word        |
| ST    | ddd:ddd.dd | 0:0.0~255:255.40 | Word: System state word        |
| N     | ddd:ddd    | 7:0、10:0~255:255 | Word: Data register            |
| F     | ddd:ddd    | 8:0~255:255      | Word: Floating number register |
| T_ACC | ddd:ddd    | 4:0~255:255      | Word: Timer ACC value          |
| T_PRE | ddd:ddd    | 4:0~255:255      | Word: Timer PRE value          |
| C_ACC | ddd:ddd    | 5:0~255:255      | Word: Counter ACC value        |
| C_PRE | ddd:ddd    | 5:0~255:255      | Word: Counter PRE value        |

ControlLogix/CompactLogix:

| Register name | Address format | Input range      | Remarks                        |
|---------------|----------------|------------------|--------------------------------|
| B-Bit         | ddd:ddd/dd     | 3~225:0~255/0~15 | Bit: Bit of data register word |
| N_Bit         | ddd:ddd/dd     | 7~225:0~255/0~15 | Bit: Bit of data register word |
| N_Bit         | ddd:ddd/o      | 7:0/0~255:255/7  | Bit: Bit of data register word |
| S             | 2:ddd          | 2:0~2:255        | Word: System state word        |
| N             | ddd:ddd        | 7:0~255:255      | Word: Data register            |
| F             | ddd:ddd        | 8:0~255:255      | Word: Floating number register |

CompactLogix\_L16ER\_TCP (Port number:44818)

| Register name | Address format | Input range | Remarks                                |
|---------------|----------------|-------------|--|
| B             | d<br>dd.ddd    | 0.0~255.255 | Bit: bool type address                 |
| I             | D<br>dd.ddd    | 0.0~255.255 | Word: 16 int int register              |
| F             | d<br>dd.ddd    | 0.0~255.99  | Double word: : 32 float float register |

MicroLogix DF1\_TCP

(Port number:44818)

| Register name | Address format | Input range | Remarks |
|---------------|----------------|-------------|---------|
|---------------|----------------|-------------|---------|

|              | <b>m<br/>a<br/>t</b> |                  |   |
|--------------|----------------------|------------------|---|
| <b>I</b>     | d<br>dd.dd<br>d/dd   | 0.0/0~255.255/15 | Bit: input image register,<br>read - only             |
| <b>O</b>     | d<br>dd.dd<br>d/dd   | 0.0/0~255.255/15 | Bit: output image register                            |
| <b>B</b>     | d<br>dd.dd<br>d/dd   | 0.0/0~255.255/15 | Bit: bit storage                                      |
| <b>T</b>     | d<br>dd.dd<br>d      | 0.0~255.255      | Bit: timer state                                      |
| <b>C</b>     | d<br>dd.dd<br>d      | 0.0~255.255      | Bit: counter state                                    |
| <b>S_Bit</b> | d<br>dd.dd<br>d/dd   | 0.0/0~255.255/15 | Bit: the bit of the system<br>register                |
| <b>N_Bit</b> | d<br>dd.dd<br>d/dd   | 0.0/0~255.255/15 | Bits: bits of a data register                         |
| <b>S</b>     | d<br>dd.dd<br>d      | 0.0~255.255      | Word: system register                                 |
| <b>N</b>     | d<br>dd.dd<br>d      | 0.0~255.255      | Word: 16-bit integer register                         |
| <b>F</b>     | d<br>dd.dd<br>d      | 0.0~255.255      | Double word: 32-bit floating<br>point number register |
| <b>TV</b>    | d<br>dd.dd<br>d      | 0.0~255.255      | Word: current value of timer                          |
| <b>CV</b>    | d<br>dd.dd<br>d      | 0.0~255.255      | Word: counter current value                           |
| <b>TS</b>    | ddd.d<br>d<br>d      | 0.0~255.255      | Word: timer setting value                             |

|    |                 |             |                         |
|----|-----------------|-------------|-------------------------|
| CS | d<br>dd.dd<br>d | 0.0~255.255 | Word: counter set value |
|----|-----------------|-------------|-------------------------|

#### 4. Instruction of connection between SK HMI and ControlLogix and CompactLogix series PLC of Alleb-Bradley Company

Open RSLinx and set corresponding PLC communication drivers

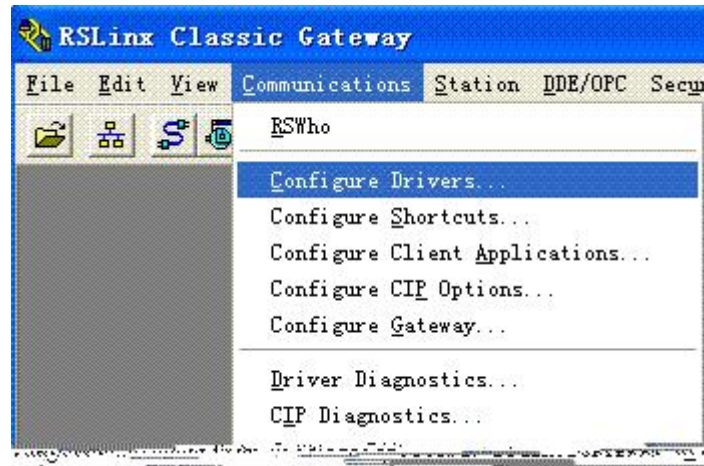

Create a driver; select serial port connection and RS-232 DF1 devices

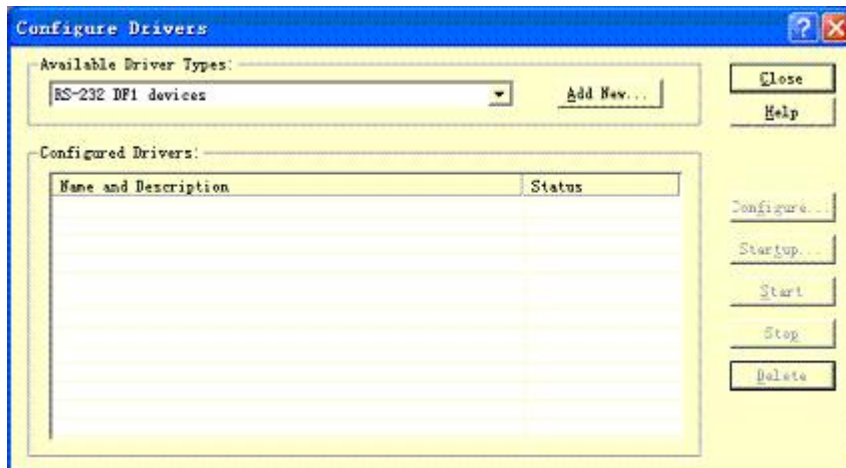

After the settings, the PLC device is available in RSLinx if there is a cable connecting PC and PLC

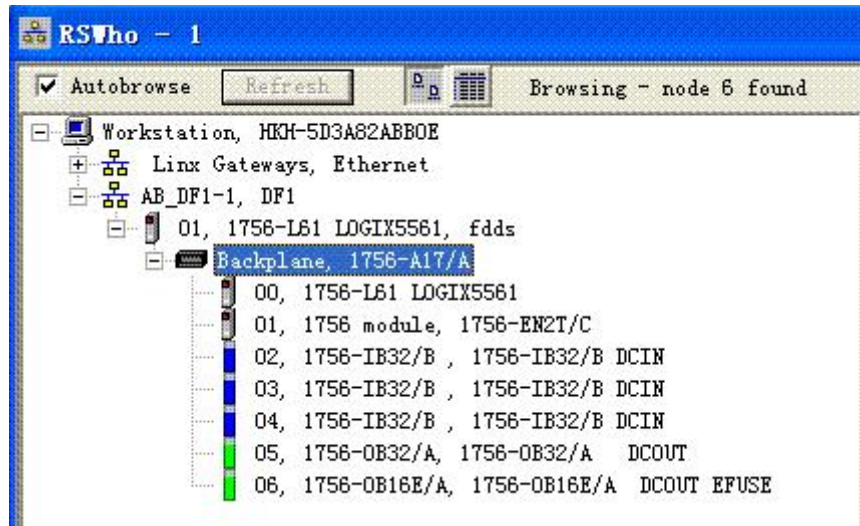

Open PLC programming software RSLogix 5000; create your project and new tags

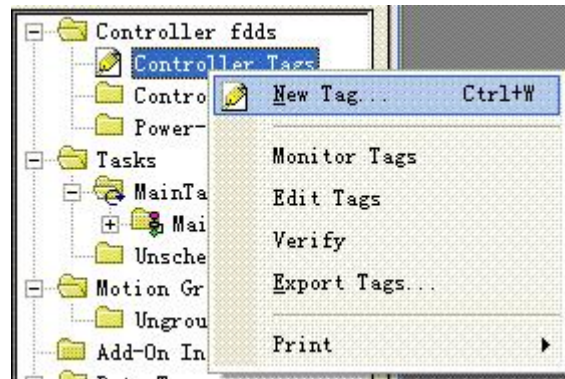

Create tags: B003, N007 and F008

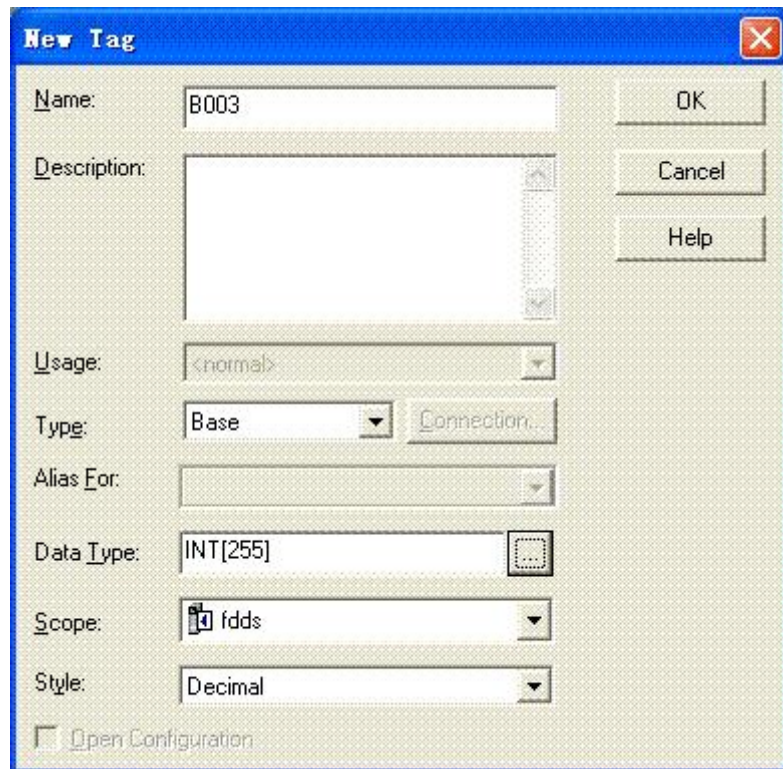

Tag list after creation:

| Scope: fdds |           |          |           |         |  |  |
|-------------|-----------|----------|-----------|---------|--|--|
| Name        | Alias For | Base Tag | Data Type | Style   |  |  |
| + B003      |           |          | INT[255]  | Decimal |  |  |
| + F008      |           |          | REAL[255] | Float   |  |  |
| + N007      |           |          | INT[255]  | Decimal |  |  |
|             |           |          |           |         |  |  |

Build address mapping

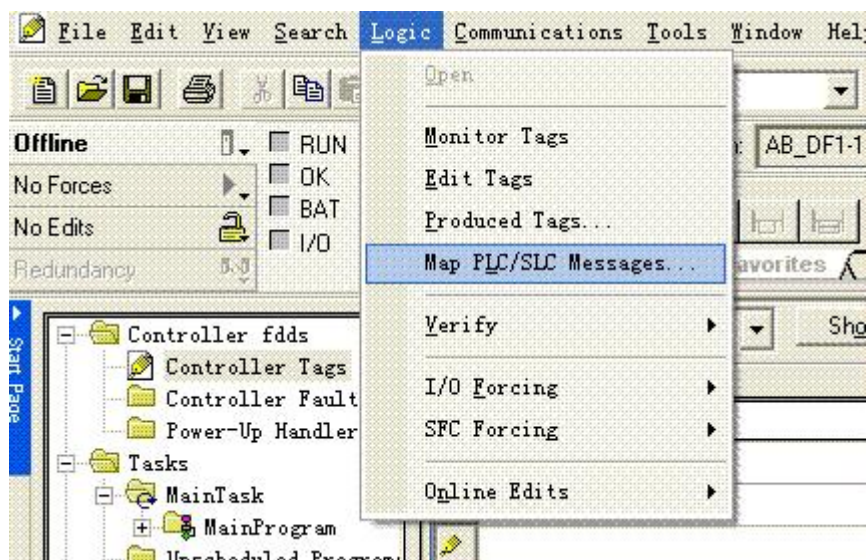



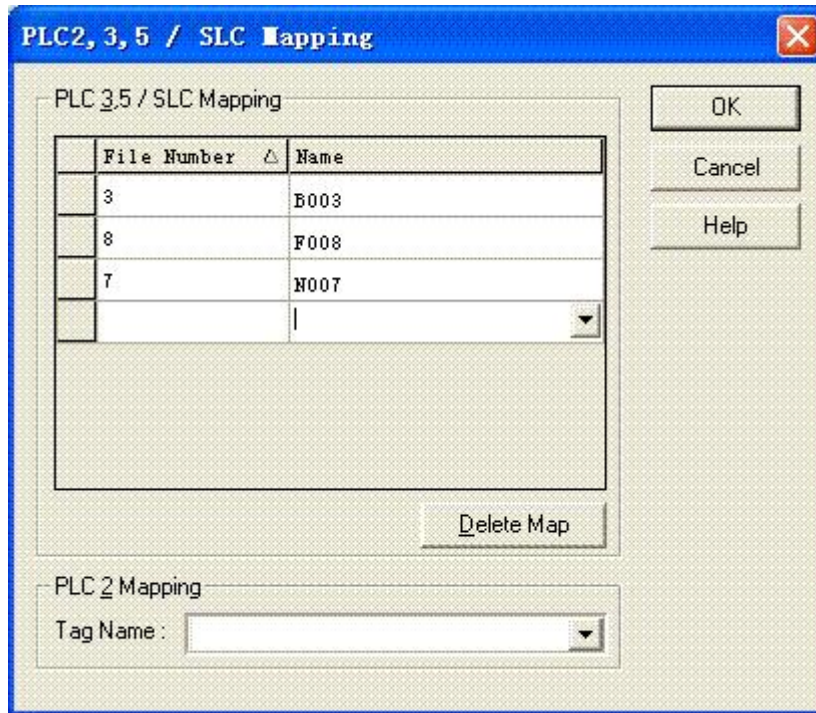

### Set PLC parameters

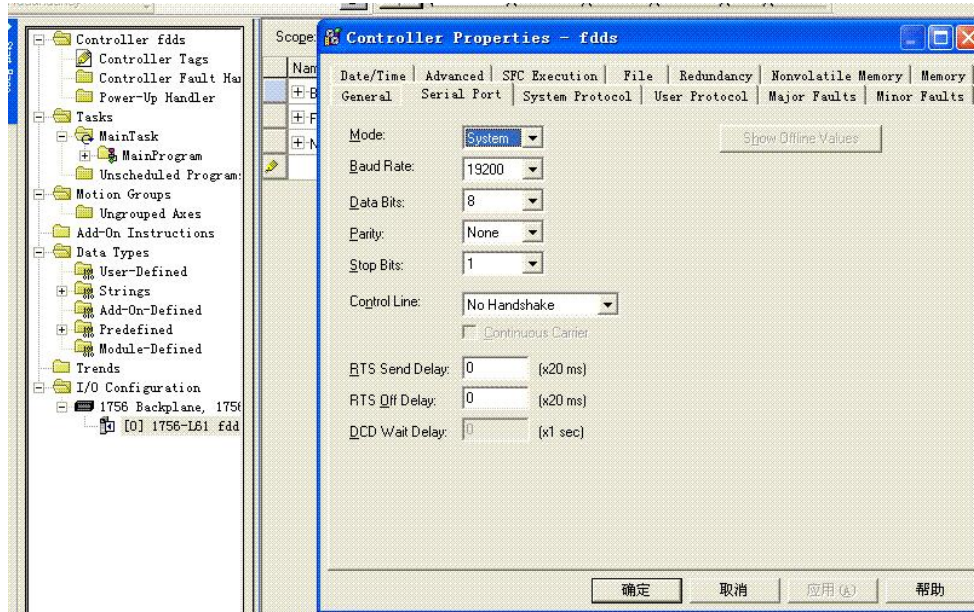

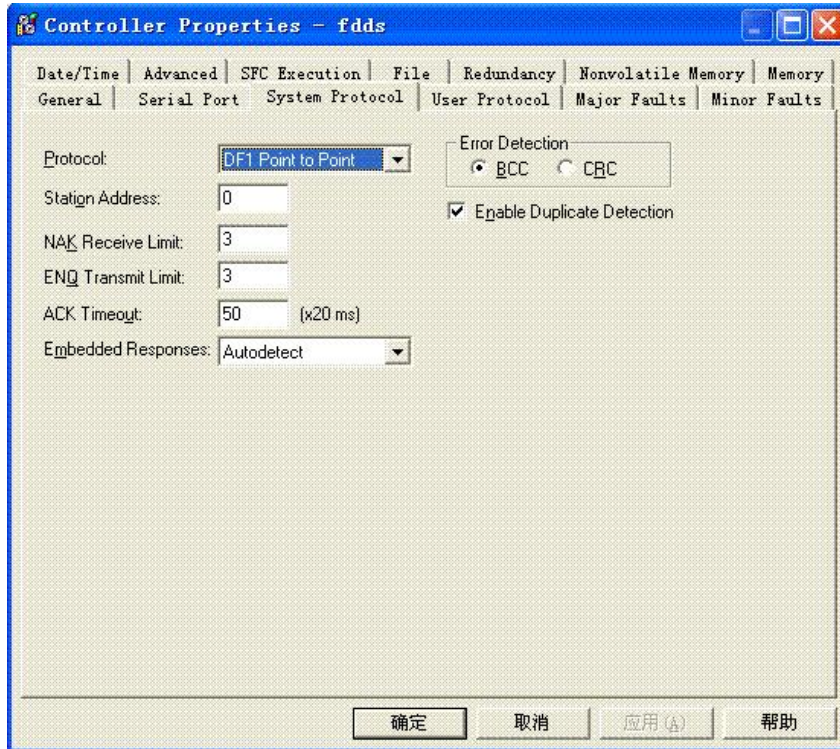

- d represents decimal system, input range is 0-9;
  - o represents octal system, input range is 0-7;
  - Bit in the remarks: represents the register can only used as bit;
  - Word in the remarks: represents the register can only used as word;
  - Read only in the remarks represents that the register can only be read but not be written;
  - The names of the registers supported by different equipment model may be different, and the scopes may also be different.
- For detailed name and scope, please consult related technical document of the connected device

#### Connect 1769 series CompactLogix series PLC

PLC new address label

Address tag correspondence

| The register | label type | array size |
|--------------|------------|------------|
| B            | bool       | 255        |
| I            | int        | 255        |
| F            | real       | 100        |

The label format must be 3 characters, such as B003,I004, and F005

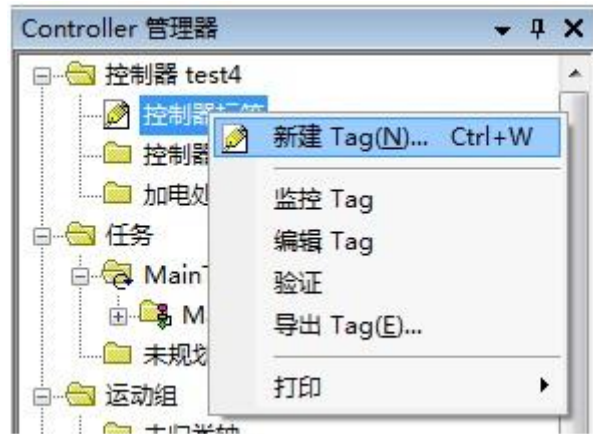

Connect the 1766 series MicroLogix DF1\_TCP

Except I/O register cannot be set to size, other register array size is set to 256, The first file number in the address input format is the file number. For example, the file number of F8 is 8, the file number of I1 is 1, and so on.

## 12.4 CAN Device Driver



This device driver is used to communicate with SK series touch screen and CAN device.

---

Before using this driver, please read this chapter and related technical instructions carefully.

How to establish a connection with a CAN device

## 1. Hardware connection

connecting cables:

| SK series touch screen COM1/COM2 |      | CAN               |      |
|----------------------------------|------|-------------------|------|
| 1                                | CANL | Pin customization | CANL |
| 4                                | CANH | Pin customization | CANH |
| 5                                | GND  | Pin customization | GND  |

## 2. Software settings

The function of CANBus is realized by calling the script system function

onCanxStart(PortID): start the CAN device

onCanxstop(PortID): close the CAN device

setBitrate (Bitrate , PortID): set the CAN communication rate

onCanxstop( CanID, CanMask, PortID ): set CAN ID filtering

recvData ( data, Len, PortID, &CanId ): Receive CAN data

sendData ( data, Len, PortID, CanId, CanType ): send CAN data

For details, please refer to "[CAN Communication Function](#)"

## 3. Case

Initialization function, it is recommended to use the initialization function to power on and initialize once

```
#include "MacroInit.h"

void Macro_main(IN *p)
{
    MacroInit
    //ToDo

    int com = 1; // 0:COM2 1:COM1
    int baudRate = 10*1000; // baud rate
    int id = 0; // Set filter ID
    int mask = 0; // Set filter mask
```

```

onCanxstop(com); // Close CAN
setBaudrate(baudRate, com); // Set the baud rate
onCanxStart(com); // Open CAN
// addFilter(id, mask, com); // Set filtering, enable filtering, CAN filtering rule references the last
CAN filtering calculation method
}

```

Read data function, it is recommended to use the global macro loop to execute

```

#include "MacroInit.h"

void Macro_main(IN *p)
{
    MacroInit
    //ToDo

    int com = 1; // 0:COM2 1:COM1
    char buf[8] = {0}; // Receive data cache
    int len = 0; // Receive data length
    int canId = 0; // Receive data ID
    int i = 0;

    len = reciveData(buf, 8, com, &canId); // Receive CAN data

    if(0 < len)
    {
        *((unsigned int *)&LocalWord[50030]) = canId; // Display receiving CAN ID to LW50030
        // 32-bit integer type
        LocalWord[50032] = len; // Display receiving data length to LW50032 16-bit integer type
        for(i=0; i< 8; ++i) // Display 8 addresses starting from LW50040
        {
            LocalWord[50040+i] = buf[i] & 0xff;
        }
    }
}

```

Write data function, trigger execution as needed

```

#include "MacroInit.h"

void Macro_main(IN *p)
{
    MacroInit
    //ToDo
}

```

```

int com = 1; // 0:COM2 1:COM1
char buf[8] = {1, 2, 3, 4, 5, 6, 7, 8}; // Set the send data is 1 2 3 4 5 6 7 8
int canId = 0x02; // Set the send data ID
int mondel = 0x0; // Standard frame:0 Extension frame:0x80000000 Remote frame:0x40000000
Remote extension frame:0xC0000000
int i = 0;

sendData(buf, 8, mondel, canId, com); // send data
}

```

## 12.5 Delta device driver

The device driver is used for SK series HMI to read and write the data or state of Delta DVP series PLC register. The serial communication connection is established through the serial port of HMI and the serial port of Delta DVP series PLC, so as to operate Delta DVP series PLC. Prior to use of the driver, one shall carefully read related technical specifications of the chapter and Delta DVP series PLC.

How to establish connection with Delta DVP series PLC

### 1. Hardware connection

Connecting cable:  
RS232 (serial port RS232 protocol)

| SK HMI | COM1/COM2 | Delta DVP series |     |
|--------|-----------|------------------|-----|
| 2      | RX        | 5                | TX  |
| 3      | TX        | 4                | RX  |
| 5      | GND       | 8                | GND |

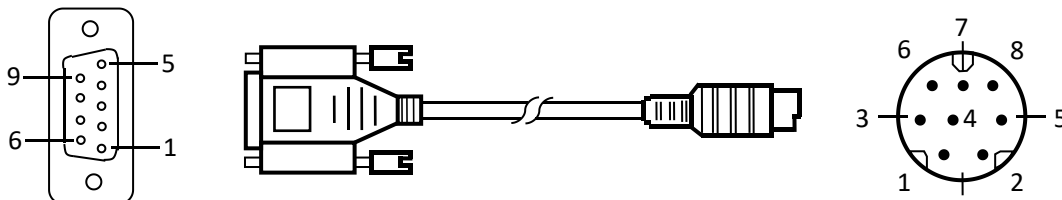

Terminal of SK series HMI is DB9F; that of Delta DVP series PLC is MD8M.

RS485 (serial port RS485 protocol)

| SK HMI | COM1/COM2 | Delta DVP series |
|--------|-----------|------------------|
| 8      | TX-       | B                |

|   |     |   |
|---|-----|---|
| 9 | TX+ | A |
|---|-----|---|

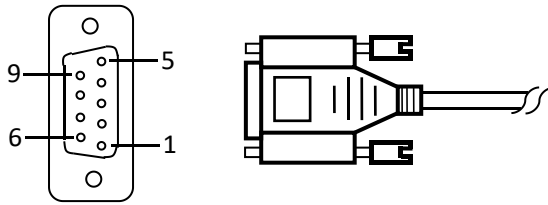

Terminal of SK HMI is DB9F, and that of Delta DVP series PLC is two-wire terminal.

## 2. Software settings

Select Delta Corporation in connection device service.

Select the corresponding item in connection device service according to the connected PLC model or supported protocol.

Ensure that the communication parameters in touch screen connection parameters and PLC station number are consistent with the PLC connected.

For settings of the PLC, refer to the technical documents of the Delta DVP series PLC.

### Default connection parameters of SK series HMI

| Setting item            | Default parameter value | Setting scope                                |
|-------------------------|-------------------------|--|
| PLC type                | Delta DVP Series        | Delta DVP Series                             |
| Communication port type | RS232                   | RS232/RS422/RS485                            |
| Baud rate               | 19200                   | 1200/2400/4800/9600/19200/38400/57600/115200 |
| Data bit length         | 8                       | 7/8  |
| Parity bit              | NONE                    | EVEN/ODD/NONE                                |
| Stop bit length         | 1                       | 1/2  |
| PLC station number      | 1                       | 0~255  |
| HMI station number      | 0                       | 0~255  |

| Supporting function | Whether it is supported |
|---------------------|-------------------------|
| Off-line simulation | Yes                     |
| On-line simulation  | Yes                     |
| Extended mode       | Yes                     |

---

### 3. Operational register and address range

| Register name | Address format | Input range | Remarks                                       |
|---------------|----------------|-------------|---|
| X             | ooo            | 0~377       | Bit: input connection point, read only        |
| Y             | ooo            | 0~377       | Bit: output connection point                  |
| M             | dddd           | 0~4095      | Bit: auxiliary relay                          |
| S             | dddd           | 0~1023      | Bit: internal relay                           |
| T             | ddd            | 0~255       | Bit: timer status                             |
| C             | ddd            | 0~255       | Bit: counter status                           |
| D             | dddd           | 0~9999      | Word: temporary data storage                  |
| TV            | ddd            | 0~255       | Word: current value of timer                  |
| CV            | ddd            | 0~199       | Word: current value of counter                |
| CV32          | ddd            | 200~255     | Double words: current value of 32-bit counter |

---

**Note:**

d represents decimal system, input range is 0-9;

o represents octal system, input range is 0-7;

Bit in the remarks: represents the register can only used as bit;

Word in the remarks: represents the register can only used as word;

Double-word in the remarks: represents that the data type of the register in configuration must be 32-bit;

Read only in the remarks represents that the register can only be read but not be written;

The names of the registers supported by different equipment model may be different, and the scopes may also be different.

For detailed name and scope, please consult related technical document of the connected device.

---

## 12.6 Emerson device driver

The device driver is used for SK series HMI to read and write the data or state of Emerson EC series PLC register. The serial communication connection is established through the serial port of HMI and the serial port of Emerson EC series PLC, so as to operate Emerson EC series PLC. Prior to use of the driver, one shall carefully read related technical specifications of the chapter and Emerson EC series PLC.



## How to establish connection with Emerson EC series PLC

### 1. Hardware connection

Connecting cable:  
RS232

| SK series HMI COM1/COM2 |     | Emerson EC |     |
|-------------------------|-----|------------|-----|
| 2                       | RX  | 5          | TX  |
| 3                       | TX  | 4          | RX  |
| 5                       | GND | 3          | GND |

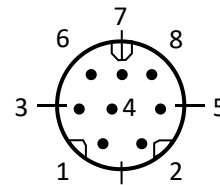
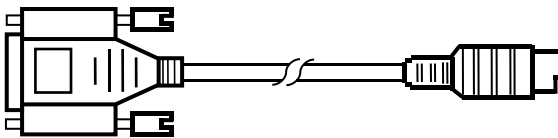

Terminal of HMI is DB9F, and that of Emerson EC series PLC is MD8M.

### 2. Software settings

Select Emerson Network Power in connection device service.

Select the corresponding item in connection device service according to the connected PLC model or supported protocol.

Ensure that the communication parameters in touch screen connection parameters and PLC station number are consistent with the PLC connected.

For settings of the PLC connected, refer to the technical documents of the Emerson EC series PLC.

Default connection parameters of HMI series touch screen

| Setting item            | Default parameter value | Setting scope                                |
|-------------------------|-------------------------|--|
| PLC type                | EC Series (RTU)         | EC Series (RTU)                              |
| Communication port type | RS232                   | RS232/RS422/RS485                            |
| Baud rate               | 9600                    | 1200/2400/4800/9600/19200/38400/57600/115200 |
| Data bit length         | 7                       | 7/8  |
| Parity bit              | EVEN                    | EVEN/ODD/NONE                                |
| Stop bit length         | 1                       | 1/2  |

|                    |   |       |
|--------------------|---|-------|
| PLC station number | 1 | 0~255 |
| HMI station number | 0 | 0~255 |

| Supporting function | Whether it is supported |
|---------------------|-------------------------|
| Off-line simulation | Yes                     |
| On-line simulation  | Yes                     |
| Extended mode       | Yes                     |

### 3. Operational register and address range

| Register name | Address format | Input range | Remarks                                     |
|---------------|----------------|-------------|---|
| X             | ooo            | 0~377       | Bit: input connection point, read only      |
| Y             | ooo            | 0~377       | Bit: output connection point                |
| M             | dddd           | 0~7999      | Bit: internal relay                         |
| SM            | ddd            | 0~255       | Bit: special internal relay                 |
| S             | ddd            | 0~999       | Bit: Stepping relay                         |
| T             | ddd            | 0~255       | Bit: timer status                           |
| C             | ddd            | 0~255       | Bit: counter status                         |
| D             | dddd           | 0~7999      | Word: temporary data storage                |
| SD            | ddd            | 0~255       | Word: special temporary data storage        |
| TV            | ddd            | 0~255       | Word: current value of timer                |
| CV            | ddd            | 0~255       | Word: current value of counter              |
| Z             | dd             | 0~15        | Word: indexed addressing register           |
| D_Double      | dddd           | 0~7999      | Double word: temporary data storage         |
| CV_Double     | ddd            | 200~255     | Double word: current value of counter       |
| SD_Double     | ddd            | 0~255       | Double word: special temporary data storage |

#### Note:

d represents decimal system, input range is 0-9;

o represents octal system, input range is 0-7;

Bit in the remarks: represents the register can only be used as bit;

Word in the remarks: represents the register can only be used as word;

Double-word in the remarks: represents that the data type of the register in configuration must be 32-bit;

Read only in the remarks represents that the register can only be read but not be written;

The names of the registers supported by different equipment model may be different, and the scopes may also be different.

For detailed name and scope, please consult related technical document of the connected device.

## 12.7 Fatek device driver

The device driver is used for SK series HMI to read and write the data or state of Fatek FB series PLC register. The serial communication connection is established through the serial port on the touch screen and the serial port of Fatek FB series PLC, so as to operate Fatek FB series PLC. Prior to use of the driver, one shall carefully read related technical specifications of the chapter and Fatek FB series PLC.

### How to establish connection with Fatek device

#### 1. Hardware connection

Connecting cable:

RS232 (serial port RS232 protocol)

| SK HMI COM1/COM2 |     | Fatek FB series |     |
|------------------|-----|-----------------|-----|
| 2                | RX  | 1               | TX  |
| 3                | TX  | 2               | RX  |
| 5                | GND | 4               | GND |

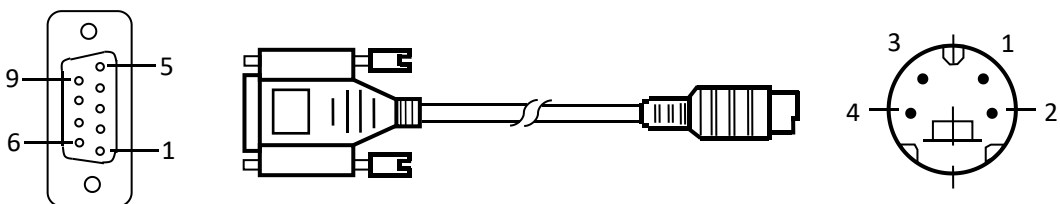

Terminal of SK series HMI is DB9F, and that of Fatek FB series PLC is MD4M.

#### 2. Software

settings

Select Fatek Automation Corp. in connection device service.

Select the corresponding item in connection device service according to the connected PLC model or supported protocol.

Ensure that the communication parameters in touch screen connection parameters and PLC station number are consistent with the PLC connected.

For settings of the PLC connected, refer to the technical documents of the Fatek FB series PLC.

Default connection parameters of HMI series touch screen

| Setting item            | Default parameter value | Setting scope                               |
|-------------------------|-------------------------|---|
| PLC type                | Fatek FB Series         | Fatek FB Series                             |
| Communication port type | RS232                   | RS232                                       |
| Baud rate               | 9600<br>0               | 1200/2400/4800/9600/19200/38400/57600/15200 |
| Data bit length         | 7                       | 7/8   |
| Parity bit              | EVEN<br>N               | EVEN/ODD/NONE                               |
| Stop bit length         | 1                       | 1/2   |
| PLC station number      | 1                       | 0~255                                       |
| HMI station number      | 0                       | 0~255                                       |

| Supporting function | Whether it is supported |
|---------------------|-------------------------|
|---------------------|-------------------------|

|                            |     |
|----------------------------|-----|
| <b>Off-line simulation</b> | Yes |
| <b>On-line simulation</b>  | Yes |
| <b>Extended mode</b>       | Yes |

### 3. Operational register and address range

| Register name | Address format | Input range | Remarks                                      |
|---------------|----------------|-------------|--|
| X             | dddd           | 0~9999      | Bit: input connection point, read only       |
| Y             | dddd           | 0~9999      | Bit: output relay                            |
| M             | dddd           | 0~9999      | Bit: internal relay                          |
| S             | dddd           | 0~9999      | Bit: stepping relay                          |
| T             | dddd           | 0~9999      | Bit: timer status                            |
| C             | dddd           | 0~9999      | Bit: counter status                          |
| R             | dddd           | 0~9999      | Word: data register                          |
| D             | dddd           | 0~9999      | Word: data register                          |
| TR            | dddd           | 0~9999      | Word: current value of timer                 |
| CR            | dddd           | 0~9999      | Word: current value of counter               |
| F             | dddd           | 0~9999      | Word: file register                          |
| DRC           | ddd            | 200~255     | Double word: current value of 32-bit counter |

Note:

d represents decimal system, input range is 0-9;

o represents octal system, input range is 0-7;

Bit in the remarks: represents the register can only be used as bit;

---

Word in the remarks: represents the register can only be used as word;

Double-word in the remarks: represents that the data type of the register in configuration must be 32-bit;

Read only in the remarks represents that the register can only be read but not be written;

The names of the registers supported by different equipment model may be different, and the scopes may also be different.

For detailed name and scope, please consult related technical document of the connected device

---

## 12.8 Fuji device driver

---

The device driver is used for SK series HMI to read and write the data or state of Fuji NB series PLC register. The serial communication connection is established through the HMI serial port and the serial port of Fuji NB series PLC, so as to operate Fuji NB series PLC. Prior to use of the driver, one shall carefully read related technical specifications of the chapter and Fuji NB series PLC.

### How to establish connection with Fuji device

#### 1. Hardware connection

Connecting cable:  
RS422 (serial port RS422 protocol)

| SK HMI COM1/COM2 |     | Fuji NB series |     |
|------------------|-----|----------------|-----|
| 6                | RX- | 4              | TX- |
| 7                | RX+ | 3              | TX+ |
| 8                | TX- | 6              | RX- |
| 9                | TX+ | 5              | RX+ |

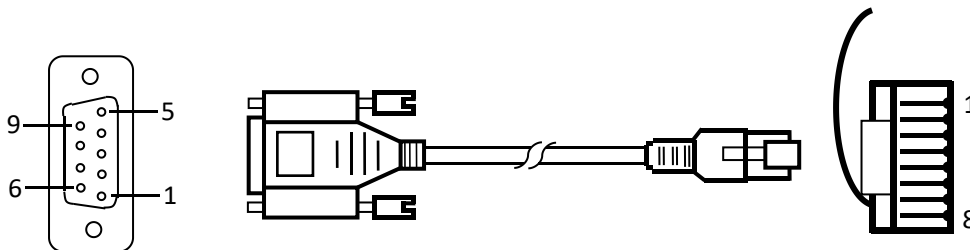

Terminal of SK HMI is DB9F, and that of Fuji NB series PLC is RJ45.

#### 2. Software settings

Select Fuji Electric Corporation in connection device service.

Select the corresponding item in connection device service according to the connected PLC model or supported protocol.

Ensure that the communication parameters in touch screen connection parameters and PLC station number are consistent with the PLC connected.

For settings of the PLC connected, refer to the technical documents of the Fuji NB series PLC.

Default connection parameters of SK HMI

| Setting item            | Default parameter value | Setting scope                                |
|-------------------------|-------------------------|--|
| PLC type                | Fuji NB Series          | Fuji NB Series                               |
| Communication port type | RS422                   | RS422  |
| Baud rate               | 19200                   | 1200/2400/4800/9600/19200/38400/57600/115200 |
| Data bit length         | 8                       | 7/8  |
| Parity bit              | ODD                     | EVEN/ODD/NONE                                |
| Stop bit length         | 1                       | 1/2  |
| PLC station number      | 0                       | 0~255  |
| HMI station number      | 0                       | 0~255  |

| Supporting function | Whether it is supported |
|---------------------|-------------------------|
| Off-line simulation | Yes                     |
| On-line simulation  | Yes                     |
| Extended mode       | Yes                     |

**3. Operational register and address range**

| Register name | Address format | Input range | Remarks                                |
|---------------|----------------|-------------|--|
| X             | hhh            | 0~7ff       | Bit: input connection point, read only |
| Y             | hhh            | 0~7ff       | Bit: output connection point           |
| M             | hhhh           | 0~7fff      | Bit: internal relay                    |
| SM            | hhhh           | 8000~81ff   | Bit: internal relay                    |
| L             | hhh            | 0~5ff       | Bit: Lockout relay                     |
| S             | hh             | 0~ff        | Bit: Stepping relay                    |
| T             | hhh            | 0~1ff       | Bit: Status of timer                   |
| C             | hh             | 0~ff        | Bit: Status of counter                 |
| D             | hhhh           | 0~7fff      | Word: Temporary data storage           |
| SD            | hhhh           | 8000~80ff   | Word: Temporary data storage           |
| TV            | hhh            | 0~1ff       | Word: Current value of timer           |

|    |    |      |                                |
|----|----|------|--------------------------------|
| CV | hh | 0~ff | Word: Current value of counter |
|----|----|------|--------------------------------|

Note:

h represents hexadecimal system, input range is 0-9, a-f;

Bit in the remarks: represents the register can only be used as bit;

Word in the remarks: represents the register can only be used as word;

Read only in the remarks represents that the register can only be read but not be written;

The names of the registers supported by different equipment model may be different, and the scopes may also be different.

For detailed name and scope, please consult related technical document of the connected device.

## 12.9 GE device driver

The device driver is used for SK series HMI to read and write the data or state of GE Fanuc series PLC register. The serial communication connection is established through the HMI serial port that of GE Fanuc series PLC, so as to operate GE Fanuc series PLC. Prior to use of the driver, one shall carefully read related technical specifications of the chapter and GE Fanuc series PLC.

### 1. Hardware connection

Connecting cable:

RS232 (serial port RS232 protocol)

| SK HMI COM1/COM2 |     | GE Fanuc series |     |
|------------------|-----|-----------------|-----|
| 2                | RX  | 4               | TX  |
| 3                | TX  | 3               | RX  |
| 5                | GND | 8               | GND |

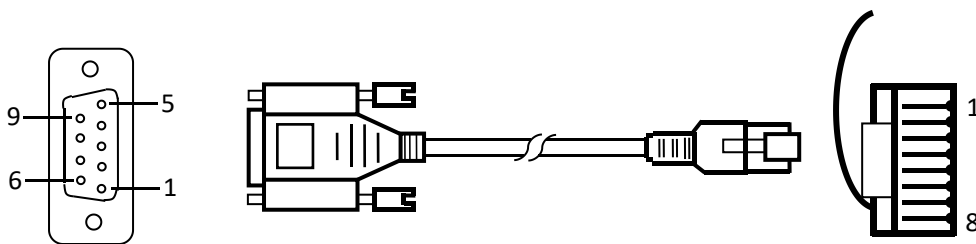

Terminal of SK HMI is DB9F, and that of GE Fanuc series PLC is RJ45.



## 2. Software settings

Select GE Corporation in connection device service.

Select the corresponding item in connection device service according to the connected PLC model or supported protocol.

Ensure that the communication parameters in touch screen connection parameters and PLC station number are consistent with the PLC connected.

For settings of the PLC connected, refer to the technical documents of the GE Fanuc series PLC.

Default connection parameters of SK HMI

| Setting item            | Default parameter value | Setting scope                                |
|-------------------------|-------------------------|--|
| PLC type                | GE Fanuc SNP-X          | GE Fanuc SNP-X/ GE Fanuc CCM                 |
| Communication port type | RS232                   | RS232/RS422/RS485                            |
| Baud rate               | 19200                   | 1200/2400/4800/9600/19200/38400/57600/115200 |
| Data bit length         | 8                       | 7/8  |
| Parity bit              | ODD                     | EVEN/ODD/NONE                                |
| Stop bit length         | 1                       | 1/2  |
| PLC station number      | 0                       | 0~255  |
| HMI station number      | 0                       | 0~255  |

| Supporting function | Whether it is supported |
|---------------------|-------------------------|
| Off-line simulation | Yes                     |
| On-line simulation  | Yes                     |
| Extended mode       | No                      |

---

### 3. Operational register and address range

| Register name | Address format | Input range | Remarks                    |
|---------------|----------------|-------------|----------------------------|
| %I            | dddd           | 1~10000     | Bit: Discrete Input        |
| %Q            | dddd           | 1~10000     | Bit: Discrete Output       |
| %M            | dddd           | 1~10000     | Bit: Internal Use          |
| %S            | ddd            | 1~128       | Bit: System Use, Read only |
| %SA           | ddd            | 1~128       | Bit: System Use, Read only |
| %SB           | ddd            | 1~128       | Bit: System Use, Read only |
| %SC           | ddd            | 1~128       | Bit: System Use, Read only |
| %T            | ddd            | 1~256       | Bit: Temporary Status      |
| %G            | dddd           | 1~7680      | Bit: Genius? Global        |
| %AI           | dddd           | 1~10000     | Word: Analog Input         |
| %AQ           | dddd           | 1~10000     | Word: Analog Output        |
| %R            | dddd           | 1~32640     | Word: Register memory      |

---

#### Note:

d represents decimal system, input range is 0-9;

o represents octal system, input range is 0-7;

Bit in the remarks: represents the register can only be used as bit;

Word in the remarks: represents the register can only be used as word;

Read only in the remarks represents that the register can only be read but not be written;

The names of the registers supported by different equipment model may be different, and the scopes may also be different.

For detailed name and scope, please consult related technical document of the connected device.

---

## 12.10 HaiWell device driver

The device driver is used for SK series HMI to read and write the data or state of Haiwell E/S/H series PLC register. The serial communication connection is established through the serial port on the touch screen and the serial port of Haiwell E/S/H series PLC, so as to operate Haiwell E/S/H series PLC. Prior to use of the driver, one shall carefully read related technical specifications of the chapter and Haiwell E/S/H series PLC.

How to establish connection with HAIWELL device

### 1. Hardware connection

Connecting cable:

RS232 (serial port RS232 protocol)

| SK HMI COM1/COM2 |     | HaiWell E/S/H series |     |
|------------------|-----|----------------------|-----|
| 2                | RX  | 2                    | TX  |
| 3                | TX  | 1                    | RX  |
| 5                | GND | 3                    | GND |

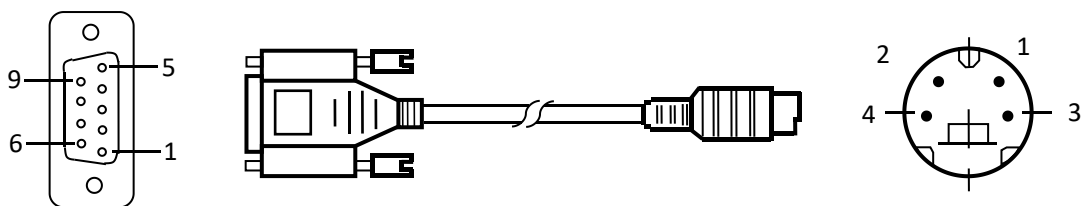

Terminal of SK series HMI is DB9F, and that of Haiwell E/S/H series PLC is MD4M.

### 2. Software settings

Select Haiwell Technology Corp. in connection device service.

Select the corresponding item in connection device service according to the connected PLC model or supported protocol.

Ensure that the communication parameters in touch screen connection parameters and PLC station number are consistent with the PLC connected.

For settings of the PLC connected, refer to the technical documents of the Haiwell E/S/H series PLC.

Default connection parameters of HMI series touch screen

| Setting item            | Default parameter value | Setting scope                                |
|-------------------------|-------------------------|--|
| Communication port type | RS232                   | RS232/RS422/RS485                            |
| Baud rate               | 19200                   | 1200/2400/4800/9600/19200/38400/57600/115200 |
| Data bit length         | 8                       | 7/8  |
| Parity bit              | NONE                    | EVEN/ODD/NONE                                |
| Stop bit length         | 2                       | 1/2  |
| PLC station number      | 1                       | 1~31   |
| HMI station number      | 0                       | 0~255  |
| Supporting function     | Whether it is supported |  |
| Off-line simulation     | Yes                     |  |
| On-line simulation      | Yes                     |  |
| Extended mode           | Yes                     |  |

### 3. Operational register and address range

| Register name | Address format | Input range | Remarks                     |
|---------------|----------------|-------------|-----------------------------|
| X             | ddd            | 0~1023      | Bit: External switch input  |
| Y             | ddd            | 0~1023      | Bit: External switch output |
| M             | ddd            | 0~12287     | Bit: Internal relay         |

|       |     |                 |                                       |
|-------|-----|-----------------|---------------------------------------|
| SM    | ddd | 0~215           | Bit: System status                    |
| S     | ddd | 0~2047          | Bit: Step status                      |
| T     | ddd | 0~1023          | Bit: Timer status                     |
| C     | ddd | 0~255           | Bit: Counter status                   |
| AI    | ddd | 0~255           | Word: Analog input register           |
| AQ    | ddd | 0~255           | Word: Analog output register          |
| V     | ddd | 0~14847         | Word: Internal register               |
| TCV   | ddd | 0~1023          | Word: current value of Timer          |
| CCV   | ddd | 0~47,<br>80~255 | Word: Current value of counter        |
| SV    | ddd | 0~154           | Word: System register                 |
| CCV32 | ddd | 0~31            | Double word: Current value of counter |

**Note:**

d represents decimal system, input range is 0-9;

Bit in the remarks: represents the register can only be used as bit;

Word in the remarks: represents the register can only be used as word;

Read only in the remarks represents that the register can only be read but not be written;

The names of the registers supported by different equipment model may be different, and the scopes may also be different.

For detailed name and scope, please consult related technical document of the connected device.

## 12.11 Hitachi device driver

The device driver is used for SK series HMI to read and write the data or state of Hitachi E/EH series PLC register. The serial communication connection is established through the HMI serial port and that of Hitachi E/EH series PLC, so as to operate Hitachi E/EH series PLC. Prior to use of the driver, one shall carefully read related technical specifications of the chapter and Hitachi E/EH series PLC.

### 1. Hardware connection

Connecting cable:

RS232 (serial port RS232 protocol)

| SK HMI COM1/COM2 |     | Hitachi E/EH series  |     |
|------------------|-----|----------------------|-----|
| 2                | RX  | 5                    | SD  |
| 3                | TX  | 6                    | RD  |
| 5                | GND | 1                    | SG  |
|                  |     | 4                    | PHL |
|                  |     | 7                    | DR  |
|                  |     | 4-7<br>Short circuit |     |

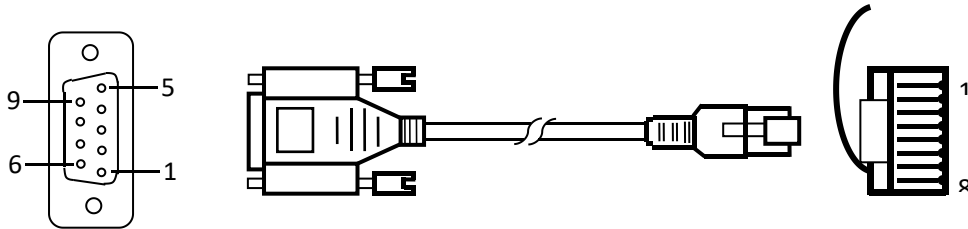

Terminal of SK HMI is DB9F, and that of AB device is RJ45.

## 2. Software settings

Select Hitachi Industrial in connection device service.

Select the corresponding item in connection device service according to the connected PLC model or supported protocol.

Ensure that the communication parameters in touch screen connection parameters and PLC station number are consistent with the PLC connected.

For settings of the PLC connected, refer to the technical documents of the Hitachi E/EH series PLC.

Default connection parameters of SK HMI

| Setting item            | Default parameter value | Setting scope                                |
|-------------------------|-------------------------|--|
| PLC type                | Hitachi E/EH Series     | Hitachi E/EH Series                          |
| Communication port type | RS232                   | RS232/RS422/RS485                            |
| Baud rate               | 19200                   | 1200/2400/4800/9600/19200/38400/57600/115200 |

|                    |      |               |
|--------------------|------|---------------|
| Data bit length    | 7    | 7/8           |
| Parity bit         | EVEN | EVEN/ODD/NONE |
| Stop bit length    | 1    | 1/2           |
| PLC station number | 0    | 0~255         |
| HMI station number | 0    | 0~255         |

| Supporting function | Whether it is supported |
|---------------------|-------------------------|
| Off-line simulation | Yes                     |
| On-line simulation  | Yes                     |
| Extended mode       | Yes                     |

### 3. Operational register and address range

| Register name | Address format | Input range | Remarks  |
|---------------|----------------|-------------|--|
| X             | hhhh           | 0~ffff      | Bit: external switch quantity input, read only |
| Y             | hhhh           | 0~ffff      | Bit: external switch quantity output           |
| M             | hhhh           | 0~ffff      | Bit: internal relay                            |
| R             | hhhh           | 0~ffff      | Bit: internal register                         |
| T             | hhhh           | 0~ffff      | Bit: status of timer                           |
| L             | hhhh           | 0~ffff      | Bit: link relay                                |
| WX            | hhhh           | 0~ffff      | Word: external switch quantity input           |
| WY            | hhhh           | 0~ffff      | Word: external switch quantity output          |
| WM            | hhhh           | 0~ffff      | Word: internal relay                           |
| WR            | hhhh           | 0~ffff      | Word: internal register                        |
| WL            | hhhh           | 0~ffff      | Word: link relay                               |

|    |      |        |                                      |
|----|------|--------|--------------------------------------|
| TC | hhhh | 0~ffff | Word: current value of timer/counter |
|----|------|--------|--------------------------------------|

Note:

h represents hexadecimal system, input range is 0-9, a-f;

Bit in the remarks: represents the register can only be used as bit;

Word in the remarks: represents the register can only be used as word;

Read only in the remarks represents that the register can only be read but not be written;

The names of the registers supported by different equipment model may be different, and the scopes may also be different.

For detailed name and scope, please consult related technical document of the connected device.

## 12.12 HollySys device driver

The device driver is used for HMI-TOOLS series touch screen to read and write the data or state of HollySys LM series PLC register. The serial communication connection is established through the serial port on the touch screen and the serial port of HollySys LM series PLC, so as to operate HollySys LM series PLC. Prior to use of the driver, one shall carefully read related technical specifications of the chapter and HollySys LM series PLC.

### How to establish connection with HOLLYSYS series PLC

#### 1. Hardware connection

Connecting cable:

RS232 (serial port RS232 protocol)

| SK HMI COM1/COM2 |     | HollySys LM series |     |
|------------------|-----|--------------------|-----|
| 2                | RX  | 3                  | TX  |
| 3                | TX  | 2                  | RX  |
| 5                | GND | 5                  | GND |

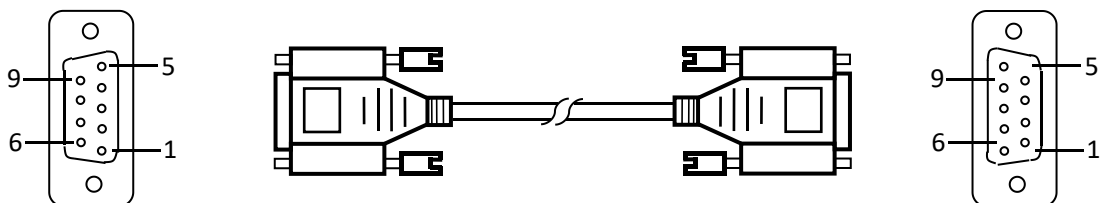



Terminal of SK series HMI is DB9F, and that of HollySys LM series PLC is DB9M.

## 2. Software settings

Select HollySys Group in connection device service.

Select the corresponding item in connection device service according to the connected PLC model or supported protocol.

Ensure that the communication parameters in touch screen connection parameters and PLC station number are consistent with the PLC connected.

For settings of the PLC connected, refer to the technical documents of the HollySys LM series PLC.

Default connection parameters of SK series HMI

| Setting item            | Default parameter value | Setting scope                                |
|-------------------------|-------------------------|--|
| PLC type                | HollySys LM Series      | HollySys LM Series                           |
| Communication port type | RS232                   | RS232/RS422/RS485                            |
| Baud rate               | 38400                   | 1200/2400/4800/9600/19200/38400/57600/115200 |
| Data bit length         | 8                       | 7/8  |
| Parity bit              | NONE                    | EVEN/ODD/NONE                                |
| Stop bit length         | 1                       | 1/2  |
| PLC station number      | 51                      | 0~255  |
| HMI station number      | 0                       | 0~255  |

| Supporting function | Whether it is supported |
|---------------------|-------------------------|
|---------------------|-------------------------|

|                     |     |
|---------------------|-----|
| Off-line simulation | Yes |
| On-line simulation  | Yes |
| Extended mode       | No  |

### 3.Operational register and address range

| Register name | Address format | Input range | Remarks   |
|---------------|----------------|-------------|---|
| IX            | ddd.o          | 0.0~511.7   | Bit: I storage area, read only  |
| QX            | ddd.o          | 0.0~511.7   | Bit: Q storage area   |
| MX            | dddd.o         | 0.0~7816.7  | Bit: M storage area   |
| IW            | ddd            | 0~510       | Word: I storage area, 8-bit register, each word occupying two addresses |
| QW            | ddd            | 0~510       | Word: Q storage area, 8-bit register, each word occupying two addresses |
| MW            | dddd           | 0~8190      | Word: M storage area, 8-bit register, each word occupying two addresses |

**Note:**

d represents decimal system, input range is 0-9;

o represents octal system, input range is 0-7;

Word in the remarks: represents the register can only used as word;

Bit in the remarks: represents the register can only used as bit;

8-bit register in the remarks: represents the address spacing between two adjacent words in the register is 2;

Read only in the remarks represents that the register can only be read but not be written;

The names of the registers supported by different equipment model may be different, and the scopes may also be different.

For detailed name and scope, please consult related technical document of the connected device

## 12.13 IDEC device driver

The device driver is used for SK series HMI to read and write the data or state of Macro Smart FC4A/FC5A/FC6A series PLC register. The serial communication connection is established through the serial port of HMI and that of Macro Smart FC4A/FC5A/FC6A series PLC, so as to operate Macro Smart FC4A/FC5A series PLC. Prior to use of the driver, one shall carefully read related technical specifications of the chapter and Macro Smart FC4A/FC5A/FC6A series PLC.

### How to establish connection with Macro Smart FC4A/FC5A series

#### 1. Hardware connection

Connecting cable:  
RS232 (serial port RS232 protocol)

| SK HMI COM1/COM2 |     | Macro Smart FC4A/FC5A |     |
|------------------|-----|-----------------------|-----|
| 2                | RX  | 3                     | TX  |
| 3                | TX  | 4                     | RX  |
| 5                | GND | 6                     | GND |
|                  |     | 7                     | GND |
|                  |     | 6-7<br>Short circuit  |     |

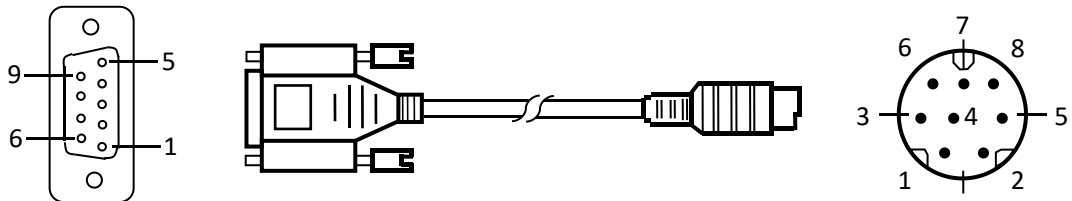

Terminal of HMI is DB9F, and that of Macro Smart FC4A/FC5A series PLC is MD8M.

#### 2. Software settings

Select Allen-Bradley in connection device service.

Select the corresponding item in connection device service according to the connected PLC model or supported protocol.

Ensure that the communication parameters in touch screen connection parameters and PLC station number are consistent with the PLC connected.

For settings of the PLC connected, refer to the relevant technical documents of the Macro Smart

FC4A/FC5A/FC6A series PLC.

### Default connection parameters of SK HMI

| Setting item            | Default parameter value | Setting scope                                |
|-------------------------|-------------------------|--|
| PLC type                | Macro Smart FC4A        | Macro Smart FC4A/ Macro Smart FC5A           |
| Communication port type | RS232                   | RS232/RS422/RS485                            |
| Baud rate               | 9600                    | 1200/2400/4800/9600/19200/38400/57600/115200 |
| Data bit length         | 7                       | 7/8  |
| Parity bit              | EVEN                    | EVEN/ODD/NONE                                |
| Stop bit length         | 1                       | 1/2  |
| PLC station number      | 1                       | 0~255  |
| HMI station number      | 0                       | 0~255  |

| Supporting function | Whether it is supported |
|---------------------|-------------------------|
| Off-line simulation | Yes                     |
| On-line simulation  | Yes                     |
| Extended mode       | Yes                     |

### 3. Operational register and address range

#### Macro Smart FC4A

| Register name | Address format | Input range | Remarks  |
|---------------|----------------|-------------|--|
| I             | ddd            | 0~255       | Bit: external switch quantity input, read only |
| Q             | ddd            | 0~255       | Bit: external switch quantity output           |
| M             | dddd           | 0~1023      | Bit: internal relay                            |
| SM            | ddd            | 0~215       | Bit: internal register                         |
| R             | ddd            | 0~255       | Word: shift register                           |
| D             | ddd            | 0~1299      | Word: data register                            |
| TV            | ddd            | 0~127       | Word: current value of timer                   |
| CV            | ddd            | 0~127       | Word: current value of counter                 |

#### Macro Smart FC5A

| Register name | Address format | Input range | Remarks                              |
|---------------|----------------|-------------|--------------------------------------|
| I             | ddd            | 0~255       | Bit: external switch quantity input, |

|    |      |         |                                      |
|----|------|---------|--------------------------------------|
|    |      |         | read only                            |
| Q  | ddd  | 0~255   | Bit: external switch quantity output |
| M  | dddd | 0~2047  | Bit: internal relay                  |
| SM | ddd  | 0~215   | Bit: internal register               |
| R  | ddd  | 0~255   | Word: shift register                 |
| D  | ddd  | 0~42000 | Word: data register                  |
| TV | ddd  | 0~255   | Word: current value of timer         |
| CV | ddd  | 0~255   | Word: current value of counter       |

Macro Smart FC6A Tcp/IP

| Register name | Address format | Input range                        | Remarks  |
|---------------|----------------|------------------------------------|--|
| I             | Ddo            | 0~627                              | Bit: external switch quantity input, read only |
| Q             | Ddo            | 0~627                              | Bit : Bit: external switch quantity output     |
| M             | Dddo           | 0~7997<br>8000~8317<br>10000~17497 | Bit: internal relay                            |
| R             | Ddd            | 0~255                              | Bit: shift register                            |
| T             | Dddd           | 0~1023                             | Bit: status of timer (read only)               |
| C             | Dddd           | 0~511                              | Bit: Status of counter(read only)              |
| D             | dddd           | 0~8499<br>10000~55999              | Word: register                                 |
| TV            | dddd           | 0~1023                             | Word: current value of timer (read only)       |
| CV            | ddd            | 0~511                              | Word: current value of counter (read only)     |
| TS            | dddd           | 0~1023                             | Word: timer set value(read only)               |
| CS            | ddd            | 0~511                              | Word: counter set value (read only)            |

Note:

d represents decimal system, input range is 0-9;

Bit in the remarks: represents the register can only be used as bit;

Word in the remarks: represents the register can only be used as word;

Read only in the remarks represents that the register can only be read but not be written;

The names of the registers supported by different equipment model may be different, and the

---

scopes may also be different.

For detailed name and scope, please consult related technical document of the connected device.

---

## 12.14 Inovance device driver

---

The device driver is used for SK series HMI to read and write the data or state of Inovance H1u/H2u series PLC register. The serial communication connection is established through the serial port of HMI and the serial port of Inovance H1u/H2u series PLC, so as to operate Inovance H1u/H2u series PLC. Prior to use of the driver, one shall carefully read related technical specifications of the chapter and Inovance H1u/H2u series PLC.

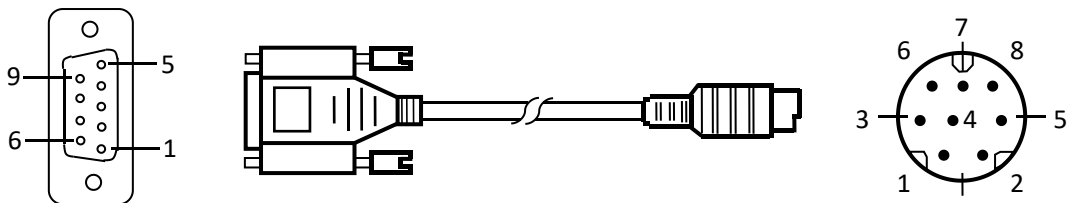

Terminal of HMI is DB9F, and that of Inovance H1u/H2u series PLC is DB9M.

### 2. Software settings

Select Inovance Technology Corp. in connection device service.

Select the corresponding item in connection device service according to the connected PLC model or supported protocol.

Ensure that the communication parameters in touch screen connection parameters and PLC station number are consistent with the PLC connected.

For settings of the PLC connected, refer to the technical documents of the Inovance H1u/H2u series PLC.

Default connection parameters of SK HMI

| Setting item            | Default parameter value | Setting scope                                |
|-------------------------|-------------------------|--|
| PLC type                | H1u/H2u                 | H1u/H2u                                      |
| Communication port type | RS232                   | RS232/RS422/RS485                            |
| Baud rate               | 9600                    | 1200/2400/4800/9600/19200/38400/57600/115200 |
| Data bit length         | 7                       | 7/8  |
| Parity bit              | EVEN                    | EVEN/ODD/NONE                                |
| Stop bit length         | 1                       | 1/2  |
| PLC station number      | 0                       | 0~255  |
| HMI station number      | 0                       | 0~255  |

| Supporting function | Whether it is supported |
|---------------------|-------------------------|
| Off-line simulation | Yes                     |
| On-line simulation  | Yes                     |
| Extended mode       | No                      |

### 3. Operational register and address range

| Register name | Address format | Input range | Remarks                         |
|---------------|----------------|-------------|---------------------------------|
| X             | oooo           | 0~377       | Bit: input coil, read only      |
| Y             | oooo           | 0~377       | Bit: output coil                |
| M             | dddd           | 0~7999      | Bit: intermediate relay         |
| SM            | dddd           | 8000~8999   | Bit: special intermediate relay |
| S             | dddd           | 0~999       | Bit: status bit                 |

|      |      |           |  |
|------|------|-----------|--|
| T    | dddd | 0~256     | Bit: status of timer                         |
| C    | dddd | 0~256     | Bit: Status of counter                       |
| D    | dddd | 0~7999    | Word: register                               |
| SD   | dddd | 8000~8999 | Word: special register                       |
| TV   | dddd | 0~255     | Word: current value of timer                 |
| CV   | dddd | 0~199     | Word: current value of counter               |
| CV32 | dddd | 200~255   | Double word: current value of 32-bit counter |

**Note:**

d represents decimal system, input range is 0-9;

o represents octal system, input range is 0-7;

Word in the remarks: represents the register can only be used as word;

Double-word in the remarks: represents that the data type of the register in configuration must be 32-bit;

Bit in the remarks: represents the register can only be used as bit;

Read only in the remarks represents that the register can only be read but not be written;

The names of the registers supported by different equipment model may be different, and the scopes may also be different.

For detailed name and scope, please consult related technical document of the connected device

## 12.15 Keyence device driver

The device driver is used for SK series HMI to read and write the data or state of Keyence KV/VisualKV series PLC register. The serial communication connection is established through the serial port on the touch screen and that of Keyence KV/VisualKV series PLC, so as to operate Keyence KV/VisualKV series PLC. Prior to use of the driver, one shall carefully read related technical specifications of the chapter and Keyence KV/VisualKV series PLC.



## How to establish connection with Keyence KV/VisualKV series PLC

### 1. Hardware connection

Connecting cable:

RS232 (serial port RS232 protocol)

| SK HMI COM1/COM2 |     | Keyence KV/VisualKV series |     |
|------------------|-----|----------------------------|-----|
| 2                | RX  | 2                          | TX  |
| 3                | TX  | 4                          | RX  |
| 5                | GND | 3                          | GND |

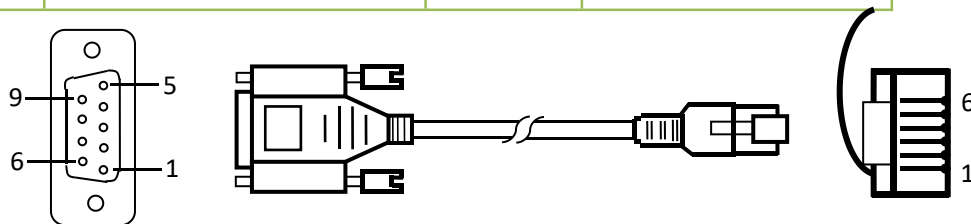

Terminal of HMI is DB9F, and that of Keyence KV/VisualKV series PLC is 6-pin registered jack.

### 2. Software settings

Select Keyence Corporation in connection device service.

Select the corresponding item in connection device service according to the connected PLC model or supported protocol.

Ensure that the communication parameters in touch screen connection parameters and PLC station number are consistent with the PLC connected.

For setting of the PLC connected, refer to the technical documents of the Keyence KV/VisualKV series PLC.

#### Default connection parameters of SK HMI

| Setting item            | Default parameter value  | Setting scope                                |
|-------------------------|--------------------------|--|
| PLC type                | KV-1000/700<br>KV-L20(R) | KV-1000/700 KV-L20(R)/ KV-10/16/24/40 KV-P16 |
| Communication port type | RS232                    | RS232/RS422/RS485                            |
| Baud rate               | 9600                     | 1200/2400/4800/9600/19200/38400/57600/115200 |
| Data bit length         | 8                        | 7/8  |
| Parity bit              | EVEN                     | EVEN/ODD/NONE                                |
| Stop bit length         | 1                        | 1/2  |
| PLC station number      | 0                        | 0~255  |
| HMI station             | 0                        | 0~255  |

| number              |                         |  |
|---------------------|-------------------------|--|
| Supporting function | Whether it is supported |  |
| Off-line simulation | Yes                     |  |
| On-line simulation  | Yes                     |  |
| Extended mode       | No                      |  |

### 3. Operational register and address range

#### KV-1000/700 KV-L20(R)

| Register name | Address format | Input range | Remarks                        |
|---------------|----------------|-------------|--------------------------------|
| R             | dddDD          | 0~99915     | Bit: input/output relay        |
| MR            | dddDD          | 0~3915      | Bit: internal auxiliary relay  |
| LR            | dddDD          | 0~3999      | Bit: latching relay            |
| CR            | ddDD           | 0~3999      | Bit: control relay             |
| T             | dddd           | 0~65534     | Bit: timer                     |
| C             | dddd           | 0~65534     | Bit: counter                   |
| DM            | dddddd         | 0~32766     | Word: data storage             |
| EM            | dddddd         | 0~511       | Word: extended data storage    |
| FM            | dddddd         | 0~11998     | Word: file register            |
| TM            | ddd            | 0~3999      | Word: temporary data storage   |
| CM            | dddddd         | 0~3999      | Word: control storage          |
| TV            | dddd           | 0~99915     | Word: current value of timer   |
| CV            | dddd           | 0~3915      | Word: current value of counter |

#### KV-10/16/24/40 KV-P16

| Register name | Address format | Input range | Remarks                                   |
|---------------|----------------|-------------|---|
| RLY           | dddDD          | 0~99915     | Bit: relay                                |
| T             | dddd           | 0~999       | Bit: timer                                |
| C             | dddd           | 0~999       | Bit: counter                              |
| DM            | dddddd         | 0~9999      | Word: data storage                        |
| TM            | ddd            | 0~99        | Word: temporary data storage              |
| TV_c          | dddd           | 0~999       | Word: current value of timer              |
| TV_p          | dddd           | 0~999       | Word: preset value of timer               |
| CV_c          | dddd           | 0~999       | Word: current value of counter            |
| CV_p          | dddd           | 0~999       | Word: preset value of counter             |
| CTH           | dddd           | 0~9         | Word: current value of high speed counter |

---

## KV-Nano

| Register name | Address format | Input scope | Remarks                              |
|---------------|----------------|-------------|--------------------------------------|
| R             | dddd           | 0~59915     | Position: relay                      |
| B             | DDDD           | 0~1FFF      | Link Relay                           |
| MR            | dddd           | 0~59915     | Internal auxiliary relay             |
| LR            | dddd           | 0~19915     | Latching relay                       |
| CR            | dddd           | 0~8915      | Control relay                        |
| VB            | DDDD           | 0~1FFF      | Working relay                        |
| T             | ddd            | 0~511       | Bit timer                            |
| C             | ddd            | 0~255       | Bit: counter                         |
| DM            | dddd           | 0~32767     | Data memory                          |
| W             | DDDD           | 0~3FFF      | Link register                        |
| TM            | dddd           | 0~511       | Temporary data storage               |
| Z             | dddd           | 1~12        | Index register                       |
| TC            | dddd           | 0~511       | Double word: timer (current value)   |
| TS            | dddd           | 0~511       | Double word: timer (set value)       |
| CC            | ddd            | 0~255       | Double word: counter (current value) |
| CS            | ddd            | 0~255       | Double word: counter (set value)     |
| CTH           | d              | 0~3         | High speed counter                   |
| CTC           | d              | 0~7         | Double word: high speed comparator   |
| CM            | dddd           | 0~8999      | Control memory                       |
| VM            | dddd           | 0~9999      | Working memory                       |

---

### Note:

d represents decimal system, input range is 0-9;

DD represents 16 bits, input range is 0-15;

Bit in the remarks: represents the register can only be used as bit;

Word in the remarks: represents the register can only be used as word;

The names of the registers supported by different equipment model may be different, and the scopes may also be different.

For detailed name and scope, please consult related technical document of the connected device.

---

## 12.16 Koyo device driver

The device driver is used for SK series HMI to read and write the data or state of Koyo SN series PLC register. The serial communication connection is established through the serial port on the touch screen and the serial port of Koyo SN series PLC, so as to operate Koyo SN series PLC. Prior to use of the driver, one shall carefully read related technical specifications of the chapter and Koyo SN series PLC.

How to establish connection with Koyo SN series PLC

Hardware connection

Connecting cable:

RS232 (serial port RS232 protocol)

| SK HMI COM1/COM2 |     | Koyo SN series |     |
|------------------|-----|----------------|-----|
| 2                | RX  | 4              | TX  |
| 3                | TX  | 3              | RX  |
| 5                | GND | 8              | GND |

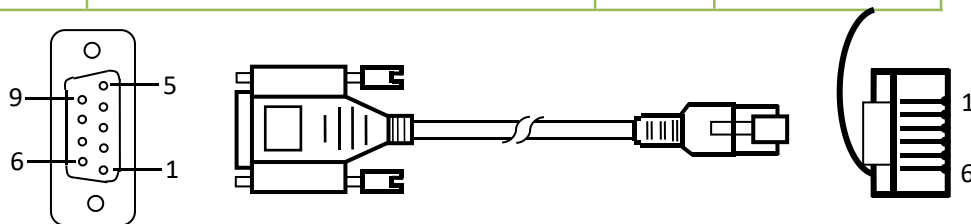

Terminal of HMI is DB9F, and that of Koyo SN series PLC is 6-pin registered jack.

### 1. Software settings

Select Koyo Electronics in connection device service.

Select the corresponding item in connection device service according to the connected PLC model or supported protocol.

Ensure that the communication parameters in touch screen connection parameters and PLC station number are consistent with the PLC connected.

For settings of the PLC connected, refer to the technical documents of the Koyo SN series PLC.

Default connection parameters of SK HMI

| Setting item | Default parameter value | Setting scope  |
|--------------|-------------------------|----------------|
| PLC type     | Koyo SN Series          | Koyo SN Series |

|                         |       |  |
|-------------------------|-------|--|
| Communication port type | RS232 | RS232/RS422/RS485                            |
| Baud rate               | 9600  | 1200/2400/4800/9600/19200/38400/57600/115200 |
| Data bit length         | 8     | 7/8  |
| Parity bit              | ODD   | EVEN/ODD/NONE                                |
| Stop bit length         | 1     | 1/2  |
| PLC station number      | 1     | 0~255  |
| HMI station number      | 0     | 0~255  |

| Supporting function | Whether it is supported |
|---------------------|-------------------------|
| Off-line simulation | Yes                     |
| On-line simulation  | Yes                     |
| Extended mode       | Yes                     |

## 2. Koyo SN Series

| Register name | Address format | Input range | Remarks                        |
|---------------|----------------|-------------|--------------------------------|
| I             | ooo            | 0~377       | Bit: input relay, read only    |
| O             | ooo            | 0~377       | Bit: output relay              |
| M             | oooo           | 0~1177      | Bit: auxiliary relay           |
| SP            | ooo            | 0~777       | Bit: special auxiliary relay   |
| S             | ooo            | 0~177       | Bit: stepping relay            |
| T             | ooo            | 0~177       | Bit: timer                     |
| C             | ooo            | 0~177       | Bit: counter                   |
| R             | ooooo          | 0~13777     | Word: data register            |
| TR            | ooooo          | 0~13777     | Word: current value of timer   |
| CR            | ooooo          | 0~13777     | Word: current value of counter |
| SR            | ooooo          | 0~13777     | Word: special data register    |

## 4. Koyo DIRECT Series

| Register name | Address format | Input range | Remarks                      |
|---------------|----------------|-------------|------------------------------|
| X             | ooo            | 0~3777      | Bit: input relay, read only  |
| Y             | ooo            | 0~3777      | Bit: output relay            |
| GX            | oooo           | 0~7777      | Bit: input relay, read only  |
| GY            | oooo           | 0~7777      | Bit: output relay            |
| C             | oooo           | 0~7777      | Bit: counter                 |
| S             | oooo           | 0~1777      | Bit: stepping relay          |
| SP            | oooo           | 0~1777      | Bit: special auxiliary relay |

|    |      |         |                                |
|----|------|---------|--------------------------------|
| CT | ooo  | 0~777   | Bit: counter                   |
| T  | ooo  | 0~777   | Bit: timer                     |
| V  | oooo | 0~77777 | Word: special data register    |
| TV | ooo  | 0~777   | Word: current value of timer   |
| CV | ooo  | 0~777   | Word: current value of counter |

KV-Nano

| 寄存器名称 | 地址格式 | 输入范围    | 备注   |
|-------|------|---------|--|
| R     | dddd | 0~59915 | Position: relay                            |
| B     | DDDD | 0~1FFF  | Position: Link Relay                       |
| MR    | dddd | 0~59915 | Position: Internal auxiliary relay         |
| LR    | dddd | 0~19915 | Position: Latching relay                   |
| CR    | dddd | 0~8915  | Position: control relay                    |
| VB    | DDDD | 0~1FFF  | Position: work relay                       |
| T     | ddd  | 0~511   | Position: timer                            |
| C     | ddd  | 0~255   | Position: counter                          |
| DM    | dddd | 0~32767 | Word: Data storage                         |
| W     | DDDD | 0~3FFF  | Word: Link register                        |
| TM    | dddd | 0~511   | Word: Temporary data storage               |
| Z     | dddd | 1~12    | Word: Index register                       |
| TC    | dddd | 0~511   | Double word: Timer (current value)         |
| TS    | dddd | 0~511   | Double word: Timer (setting value)         |
| CC    | ddd  | 0~255   | Double word: Counter (current value)       |
| CS    | ddd  | 0~255   | Double word: Counter (setting value)       |
| CTH   | d    | 0~3     | Double word: High-speed counter            |
| CTC   | d    | 0~7     | Double word: High speed counter comparator |
| CM    | dddd | 0~8999  | word: Control storage                      |
| VM    | dddd | 0~9999  | word: Working memory                       |

---

Note:

o represents octal system, input range is 0-7;

Word in the remarks: represents the register can only be used as word;

Double-word in the remarks: represents that the data type of the register in configuration must be 32-bit;

Bit in the remarks: represents the register can only be used as bit;

Read only in the remarks represents that the register can only be read but not be written;

The names of the registers supported by different equipment model may be different, and the scopes may also be different.

For detailed name and scope, please consult related technical document of the connected device

---

## 12.17 LG device driver

---

The device driver is used for SK HMI to read and write the data or state of LG Master-K series PLC register. The serial communication connection is established through the serial port on the touch screen and the serial port of LG Master-K series PLC, so as to operate LG Master-K series PLC. Prior to use of the driver, one shall carefully read related technical specifications of the chapter and LG Master-K series PLC.

How to establish connection with LG Master-K series PLC

### 1. Hardware connection

Connecting cable:

RS232-using CNet protocol (serial port RS232 protocol)

| SK HMI COM1/COM2 |     | LG Master-K |     |
|------------------|-----|-------------|-----|
| 2                | RX  | 7           | TX  |
| 3                | TX  | 4           | RX  |
| 5                | GND | 5           | GND |



Terminal of HMI is DB9F, and that of LG Master-K series PLC is DB9M.

RS232-Employ KLoader protocol

| SK HMI COM1/COM2 |     | LG Master-K |     |
|------------------|-----|-------------|-----|
| 2                | RX  | 3           | TX  |
| 3                | TX  | 2           | RX  |
| 5                | GND | 5           | GND |

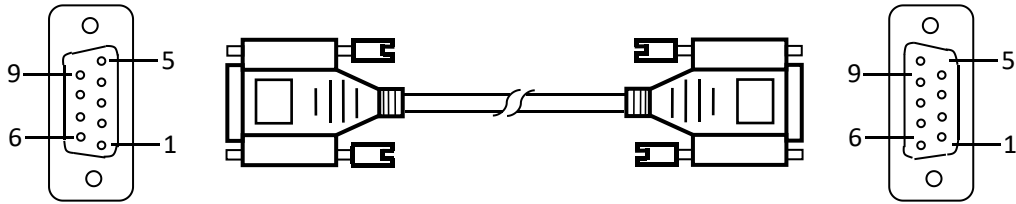

Terminal of HMI is DB9F, and that of LG Master-K series PLC is DB9M.

RS485

| SK HMI COM1/COM2 |    | LG Master-K |  |
|------------------|----|-------------|--|
| 8                | D- | B           |  |
| 9                | D+ | A           |  |

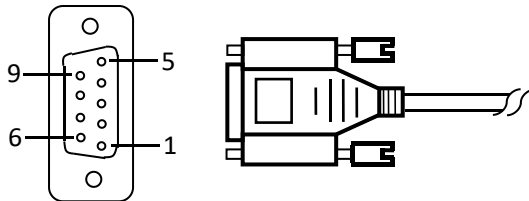

Terminal of HMI is DB9F, and that of LG Master-K series PLC is two-wire terminal.

RS232-K10S1

| SK HMI COM1/COM2 |     | LG Master-K |     |
|------------------|-----|-------------|-----|
| 2                | RX  | 4           | TX  |
| 3                | TX  | 1           | RX  |
| 5                | GND | 6           | GND |

Terminal of HMI is DB9F, and that of LG Master-K series PLC is MD6M.

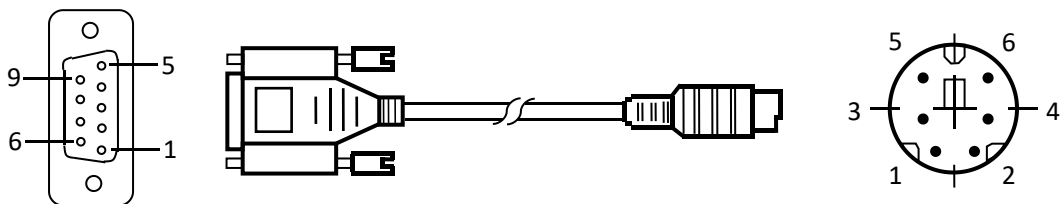



## 2. Software settings

Select LG Industrial Systems in connection device service.

Select the corresponding item in connection device service according to the connected PLC model or supported protocol.

Ensure that the communication parameters in touch screen connection parameters and PLC station number are consistent with the PLC connected.

For settings of the PLC connected, refer to the technical documents of the LG Master-K series PLC.

### Default connection parameters of SK HMI

| Setting item            | Default parameter value | Setting scope                                |
|-------------------------|-------------------------|--|
| PLC type                | LG Master-K Cnet        | LG Master-K Cnet/K Loader/K10s1              |
| Communication port type | RS232                   | RS232/RS422/RS485                            |
| Baud rate               | 19200                   | 1200/2400/4800/9600/19200/38400/57600/115200 |
| Data bit length         | 8                       | 7/8  |
| Parity bit              | NONE                    | EVEN/ODD/NONE                                |
| Stop bit length         | 1                       | 1/2  |
| PLC station number      | 0                       | 0~255  |
| HMI station number      | 0                       | 0~255  |

| Supporting function | Whether it is supported |
|---------------------|-------------------------|
| Off-line simulation | Yes                     |
| On-line simulation  | Yes                     |
| Extended mode       | Yes                     |

## 3. Operational register and address range

Operational address range of Kxxx series PLC:

| Register name | Address format | Input range | Remarks                |
|---------------|----------------|-------------|------------------------|
| P_Bit         | dddh           | 0~255f      | Bit: input/output area |
| M_Bit         | dddh           | 0~255f      | Bit: auxiliary relay   |
| K_Bit         | dddh           | 0~255f      | Bit: protection relay  |
| L_Bit         | dddh           | 0~255f      | Bit: link relay        |
| F_Bit         | dddh           | 0~255f      | Bit: special relay     |

|    |      |        |                                |
|----|------|--------|--------------------------------|
| P  | dddh | 0~255f | Word: input/output area        |
| M  | dddh | 0~255f | Word: auxiliary relay          |
| K  | dddh | 0~255f | Word: protection relay         |
| L  | dddh | 0~255f | Word: link relay               |
| F  | dddh | 0~255f | Word: special relay            |
| T  | ddd  | 0~255  | Bit: timer relay               |
| C  | ddd  | 0~255  | Bit: counter relay             |
| S  | dddd | 0~9999 | Word: stepping register        |
| D  | dddd | 0~9999 | Word: data register            |
| TV | ddd  | 0~255  | Word: current value of timer   |
| CV | ddd  | 0~255  | Word: current value of counter |

XGB CPU series PLC operable address range (via PLC RS232 download port communication):

| 寄存器名称 | 地址格式  | 输入范围     | 备注                              |
|-------|-------|----------|---------------------------------|
| P_Bit | dddhh | 0-1023f  | Bit: input/output area          |
| M_Bit | dddhh | 0-1023f  | Bit: auxiliary relay            |
| F_Bit | dddhh | 0-1023f  | Bit: special relay              |
| L_Bit | dddhh | 0-2047f  | Bit: link relay                 |
| K_Bit | dddhh | 0-4095f  | Bit: protection relay           |
| D_Bit | dddhh | 0-10239f |                                 |
| T     | dddd  | 0-1023   | Bit: timer relay                |
| C     | dddd  | 0-1023   | Bit: counter relay              |
| TV    | dddd  | 0-1023   | Word: current value of timer    |
| CV    | dddd  | 0-1023   | Word: current value of counter  |
| P     | dddd  | 0-1023   | Word: input/output area         |
| M     | dddd  | 0-1023   | Word: auxiliary relay           |
| F     | dddd  | 0-1023   | Word: special relay (read only) |
| L     | dddd  | 0-2047   | Word: link relay                |
| K     | dddd  | 0-4095   | Word: protection relay          |
| D     | dddd  | 0-10239  | Word: data register             |
| R     | dddd  | 0-10239  | Word: stepping register         |
| ZR    | dddd  | 0-10239  | Word:                           |
| S     | ddd   | 0-127    | Word: stepping register         |
| Z     | ddd   | 0-127    | Word:                           |

|   |       |           |                   |
|---|-------|-----------|-------------------|
| U | dd.dd | 0.0-10.31 | Word: (read only) |
|---|-------|-----------|-------------------|

Operational address range of XGB CNET series PLC:

| Register name | Address format | Input range | Remarks                 |
|---------------|----------------|-------------|-------------------------|
| P             | dddh           | 0~127f      | Word: input/output area |
| M             | dddh           | 0~255f      | Word: auxiliary relay   |
| K             | dddh           | 0~2559f     | Word: protection relay  |
| L             | dddh           | 0~1279f     | Word: link relay        |
| F             | dddh           | 0~255f      | Word: special relay     |
| T             | ddd            | 0~255       | Bit: timer relay        |
| C             | ddd            | 0~255       | Bit: counter relay      |
| S             | ddd            | 0~127.99    | Word: stepping register |
| D             | dddd           | 0~5119      | Word: data register     |
| N             | dddd           | 0~3935      |                         |
| Z             | ddd            | 0~127       |                         |
| ZR            | dddd           | 0~1023      |                         |
| U             | d              | 0~7.31      |                         |

XGB TCP/IP

| 寄存器名称 | 地址格式  | 输入范围    | 备注                              |
|-------|-------|---------|---------------------------------|
| P_Bit | dddhh | 0-2047f | Bit: input/output area          |
| M_Bit | dddhh | 0-2047f | Bit: auxiliary relay            |
| F_Bit | dddhh | 0-2047f | Bit: special relay              |
| L_Bit | dddhh | 0-4095f | Bit: link relay                 |
| K_Bit | dddhh | 0-8191f | Bit: protection relay           |
| T     | dddd  | 0-2047  | Bit: timer relay                |
| C     | dddd  | 0-2047  | Bit: counter relay              |
| TV    | dddd  | 0-2047  | Word: current value of timer    |
| CV    | dddd  | 0-2047  | Word: current value of counter  |
| P     | dddd  | 0-2047  | Word: input/output area         |
| M     | dddd  | 0-2047  | Word: auxiliary relay           |
| F     | dddd  | 0-2047  | Word: special relay (read only) |
| L     | dddd  | 0-4095  | Word: link relay                |
| K     | dddd  | 0-8191  | Word: protection relay          |

---

|   |       |           |                         |
|---|-------|-----------|-------------------------|
| D | dddd  | 0-19999   | Word: data register     |
| R | dddd  | 0-16383   |                         |
| S | ddd   | 0-127     | Word: stepping register |
| Z | ddd   | 0-127     |                         |
| U | dd.dd | 0.0-11.31 |                         |
| N | dddd  | 0-10239   | Word: (read only)       |

---

Note:

d represents decimal system, input range is 0-9;

h represents hexadecimal system, input range is 0-9, a-f;

Word in the remarks: represents the register can only be used as word;

Bit in the remarks: represents the register can only be used as bit;

The names of the registers supported by different equipment model may be different, and the scopes may also be different.

For detailed name and scope, please consult related technical document of the connected device

---

## 12.18 Matsushita device driver

---

The device driver is used for SK HMI to read and write the data or state of Matsushita FP series PLC register. The serial communication connection is established through the serial port on the touch screen and the serial port of Matsushita FP series PLC, so as to operate Matsushita FP series PLC. Prior to use of the driver, one shall carefully read related technical specifications of the chapter and Matsushita FP series PLC.

How to establish connection with Matsushita FP series PLC

### 1. Hardware connection

Connecting cable:  
RS232-FP0/FP2/FP2SH/FPM

| SK HMI COM1/COM2 |     | Matsushita FP series |     |
|------------------|-----|----------------------|-----|
| 2                | RX  | 3                    | TX  |
| 3                | TX  | 2                    | RX  |
| 5                | GND | 1                    | GND |

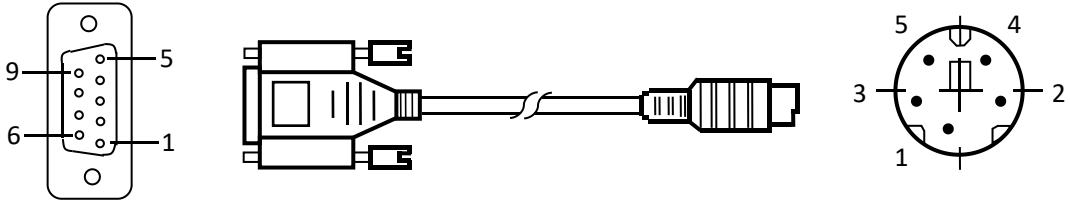

Terminal of HMI is DB9F, and that of Matsushita FP series PLC is MD5M.

### RS422-FP1

| SK HMI COM1/COM2 |     | Matsushita FP series |     |
|------------------|-----|----------------------|-----|
| 6                | RX- | 2                    | TX- |
| 7                | RX+ | 5                    | TX+ |
| 8                | TX- | 3                    | RX- |
| 9                | TX+ | 6                    | RX+ |

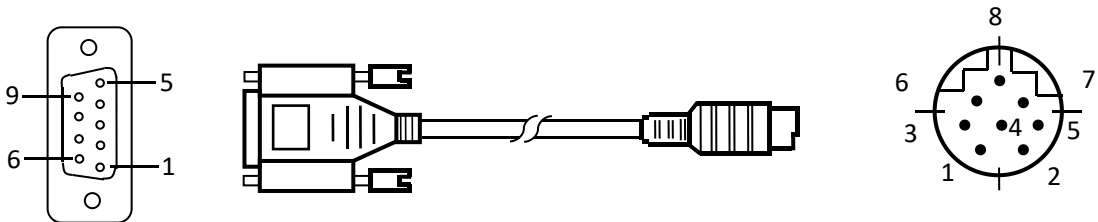

Terminal of HMI is DB9F, and that of Matsushita FP series PLC is MD8M.

## 2. Software settings

Select MATSUSHITA in connection device service.

Select the corresponding item in connection device service according to the connected PLC model or supported protocol.

Ensure that the communication parameters in touch screen connection parameters and PLC station number are consistent with the PLC connected.

For settings of connecting PLC, please refer to the technical documents of the Matsushita FP series PLC.

### Default connection parameters of SK HMI

| Setting item | Default parameter | Setting scope |
|--------------|-------------------|---------------|
|--------------|-------------------|---------------|

|                         | value     |  |
|-------------------------|-----------|--|
| PLC type                | FP Series | FP Series                                    |
| Communication port type | RS232     | RS232/RS422/RS485                            |
| Baud rate               | 9600      | 1200/2400/4800/9600/19200/38400/57600/115200 |
| Data bit length         | 8         | 7/8  |
| Parity bit              | ODD       | EVEN/ODD/NONE                                |
| Stop bit length         | 1         | 1/2  |
| PLC station number      | 1         | 0~255  |
| HMI station number      | 0         | 0~255  |

| Supporting function | Whether it is supported |
|---------------------|-------------------------|
| Off-line simulation | Yes                     |
| On-line simulation  | Yes                     |
| Extended mode       | No                      |

### 3. Operational register and address range

| Register name | Address format | Input range | Remarks                                |
|---------------|----------------|-------------|--|
| X             | ddddh          | 0~9999f     | Bit: external input, read only         |
| Y             | ddddh          | 0~9999f     | Bit: external output                   |
| R             | ddddh          | 0~9999f     | Bit: internal relay                    |
| L             | ddddh          | 0~9999f     | Bit: link relay                        |
| T             | dddd           | 0~9999      | Bit: status of timer, read only        |
| C             | dddd           | 0~9999      | Bit: status of counter, read only      |
| WX            | dddd           | 0~9999      | Word: external input, read only        |
| WY            | dddd           | 0~9999      | Word: external output                  |
| WR            | dddd           | 0~9999      | Word: internal relay                   |
| WL            | dddd           | 0~9999      | Word: link relay                       |
| DT            | dddd           | 0~99999     | Word: data register                    |
| LD            | dddd           | 0~99999     | Word: link register                    |
| FL            | dddd           | 0~99999     | Word: file register                    |
| SV            | dddd           | 0~9999      | Word: timer/counter set value area     |
| EV            | dddd           | 0~9999      | Word: timer/counter process value area |

Note:

---

d represents decimal system, input range is 0-9;

h represents hexadecimal system, input range is 0-9, a-f;

Word in the remarks: represents the register can only be used as word;

Bit in the remarks: represents the register can only be used as bit;

Read only in the remarks represents that the register can only be read but not be written;

The names of the registers supported by different equipment model may be different, and the scopes may also be different.

For detailed name and scope, please consult related technical document of the connected device

---

## 12.19 Mitsubishi device driver



---

The device driver is used for SK HMI to read and write the data or state of Melsec FXxn/Q00J/C24N series PLC register. The serial communication connection is established through the serial port on the touch screen and the serial port of Melsec FXxn/Q00J/C24N series PLC, so as to operate Melsec FXxn/Q00J/C24N series PLC. Prior to use of the driver, one shall carefully read the related technical specifications of the chapter and Melsec FXxn/Q00J/C24N series PLC.

How to establish connection with Melsec FXxn/Q00J/Q00U/C24N series PLC

### 1. Hardware connection

Connecting cable:

RS422- Melsec-FXxn/FX3U/3G (serial port RS232 protocol)

| SK HMI COM1/COM2 |     | Melsec-FXxn |     |
|------------------|-----|-------------|-----|
| 6                | RX- | 4           | TX- |
| 7                | RX+ | 7           | TX+ |
| 8                | TX- | 1           | RX- |
| 9                | TX+ | 2           | RX+ |

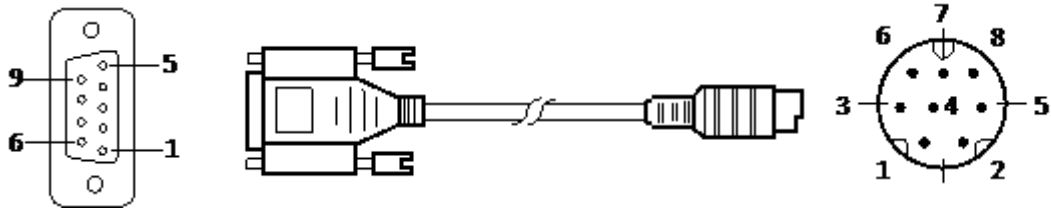

Terminal of HMI series touch screen is DB9F, and that of Melsec FXxn series PLC is MD8M.

### RS232- Melsec-Q00J/Q00U

| SK HMI COM1/COM2 |     | Q00J CPU |     |
|------------------|-----|----------|-----|
| 2                | RX  | 2        | TX  |
| 3                | TX  | 1        | RX  |
| 5                | GND | 3        | GND |

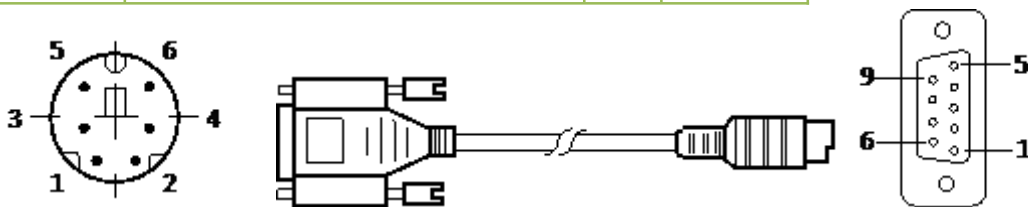

Terminal of HMI series touch screen is DB9F, and that of Melsec FXxn series PLC is MD8M.

Note:

Q00U connection instructions

Q00U 6 pin 5,6 short connection

MITSUBISHI programming software parameters >PLC parameters -- > serial communication settings

Check the use of serial communication function, baud rate select 115200, tick and check, tick the

Run write

Using MITSUBISHI communications lines, via direct wiring and HMI connections

### RS232- Melsec-QC24N module

| SK HMI COM1/COM2 |     | Q00J CPU |     |
|------------------|-----|----------|-----|
| 2                | RX  | 3        | TX  |
| 3                | TX  | 2        | RX  |
| 5                | GND | 5        | GND |



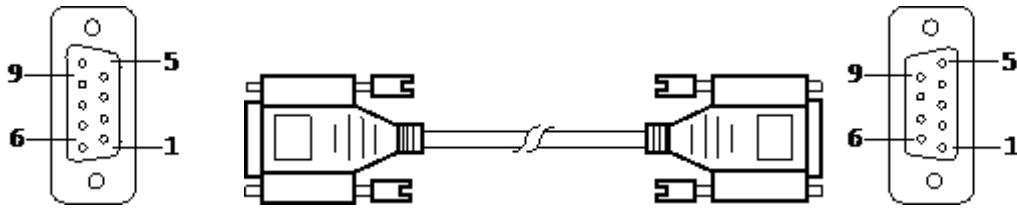

Terminal of HMI series touch screen is DB9F, and that of Melsec QC24N module is MB9M.

## 2. Software settings

Select MITSUBISHI in connection device service.

Select the corresponding item in connection device service according to the connected PLC model or supported protocol.

Ensure that the communication parameters in touch screen connection parameters and PLC station number are consistent with the PLC connected.

For settings of the PLC connected, refer to the technical documents of the Melsec FXxn/Q00J/C24N series PLC.

### Default connection parameters of SK HMI

| Setting item            | Default parameter value | Setting scope                                |
|-------------------------|-------------------------|--|
| PLC type                | Melsec-FX2N             | Melsec-FX/ FX2N/ FX3U/3G /Q_C24N Q00J        |
| Communication port type | RS232                   | RS232/RS422/RS485                            |
| Baud rate               | 9600                    | 1200/2400/4800/9600/19200/38400/57600/115200 |
| Data bit length         | 7                       | 7/8  |
| Parity bit              | EVEN                    | EVEN/ODD/NONE                                |
| Stop bit length         | 1                       | 1/2  |
| PLC station number      | 0                       | 0~255  |
| HMI station number      | 0                       | 0~255  |

| Supporting function | Whether it is supported |
|---------------------|-------------------------|
| Off-line simulation | Yes                     |
| On-line simulation  | Yes                     |

Extended mode

No

### 3. Operational register and address range

Melsec-FXxn/FX3U/3G/ FX3U-Ethernet

| Register name | Address format | Input range  | Remarks                                      |
|---------------|----------------|--------------|--|
| X             | oooo           | 0~377        | Bit: input coil, read only                   |
| Y             | oooo           | 0~377        | Bit: output coil                             |
| M             | dddd           | 0~7999       | Bit: intermediate relay                      |
| SM            | dddd           | 8000~8999    | Bit: special intermediate relay              |
| S             | dddd           | 0~999        | Bit: status bit                              |
| T             | dddd           | 0~256        | Bit: status of timer                         |
| C             | dddd           | 0~256        | Bit: status of timer                         |
| D_Bit         | dddd.dd        | 0.00~7999.15 | Bit: bit of 16-bit register                  |
| D             | dddd           | 0~7999       | Word: register                               |
| SD            | dddd           | 8000~8999    | Word: special register                       |
| TV            | dddd           | 0~255        | Word: current value of timer                 |
| CV            | dddd           | 0~199        | Word: current value of counter               |
| CV32          | dddd           | 200~255      | Double word: current value of 32-bit counter |

FX5U/FX5U-Ethernet

| Register name | Address format | Input range                 | Remarks                                 |
|---------------|----------------|-----------------------------|---|
| X             | oooo           | 0~1777                      | Bit: input coil, read only              |
| Y             | oooo           | 0~1777                      | Bit: output coil                        |
| M             | dddd           | 0~7679                      | Bit: internal relay                     |
| L             | dddd           | 0~7679                      | Bit: latching relay                     |
| F             | ddd            | 0~127                       | Bit: alarm relay                        |
| TS            | ddd            | 0~511                       | Bit: timer contact                      |
| CS            | ddd            | 0~255                       | Bit: counter contact                    |
| S             | dddd           | 0~4095                      | Bit: stepping relay                     |
| SM            | dddd           | 0~9999                      | Bit: special relay                      |
| B             | hh             | 0-ff (hexadecimal notation) | Bit: $\overline{\text{L}}$ : link relay |
| D_Bit         | dddd.dd        | 0.0~7999.15                 | Bit: bit of 16-bit register             |
| D             | dddd           | 0~7999                      | Word: register                          |
| R             | dddd           | 0~32767                     | Word: cumulative current value of timer |
| W             | hhh            | 0-1ff                       | Word: link register                     |

|    |      |                        |                                 |
|----|------|------------------------|---------------------------------|
|    |      | (hexadecimal notation) |                                 |
| CN | ddd  | 0~255                  | Word: current value of register |
| TN | ddd  | 0~511                  | Word: current value of timer    |
| SD | dddd | 0~11999                | Word: special register          |

#### Melsec-Q00J/QC24N

| Register name | Address format | Input range | Remarks                        |
|---------------|----------------|-------------|--------------------------------|
| X             | hhh            | 0~7ff       | Bit: input relay, read only    |
| Y             | hhh            | 0~7ff       | Bit: output relay              |
| M             | dddd           | 0~8191      | Bit: internal relay            |
| L             | dddd           | 0~2047      | Bit: latching relay            |
| F             | dddd           | 0~2047      | Bit: alarm                     |
| V             | dddd           | 0~2047      | Bit: indexing relay            |
| S             | dddd           | 0~2047      | Bit: stepping relay            |
| B             | hhh            | 0~7ff       | Bit: conversion relay          |
| SB            | hhh            | 0~3ff       | Bit: special link relay        |
| T             | ddd            | 0~511       | Bit: status of timer           |
| C             | ddd            | 0~511       | Bit: status of counter         |
| D             | dddd           | 0~11135     | Word: data register            |
| W             | hhh            | 0~7ff       | Word: conversion register      |
| SW            | hhh            | 0~3ff       | Word: special link register    |
| Z             | d              | 0~9         | Word: index register           |
| TV            | ddd            | 0~511       | Word: current value of timer   |
| CV            | ddd            | 0~511       | Word: current value of counter |

#### Q00U

| Register name | Address format | Input range | Remarks                     |
|---------------|----------------|-------------|-----------------------------|
| X             | hhhh           | 0~1fff      | Bit: input relay, read only |
| Y             | hhhh           | 0~1fff      | Bit: output relay           |
| M             | dddd           | 0~8191      | Bit: internal relay         |
| L             | dddd           | 0~8191      | Bit: latching relay         |
| F             | dddd           | 0~2047      | Bit: alarm relay            |
| V             | dddd           | 0~2047      | Bit: indexing relay         |
| B             | ffff           | 0~1fff      | Bit: conversion relay       |
| T             | ddd            | 0~2047      | Bit: status of timer        |
| C             | dddd           | 0~1023      | Bit: status of counter      |
| SB            | hhh            | 0~7ff       | Bit: special link relay     |

|       |        |             |                                |
|-------|--------|-------------|--------------------------------|
| SM    | ddd    | 0~2047      | Bit: special relay             |
| D_Bit | Dddd.h | 0.0~12287.f | Bit: bit of 16-bit register    |
| D     | Dddd   | 0~12287     | Word: data register            |
| W     | Hhhh   | 0~1fff      | Word: conversion register      |
| TV    | Dddd   | 0~2047      | Word: current value of timer   |
| CV    | Dddd   | 0~1023      | Word: current value of counter |
| SW    | Hhh    | 0~7ff       | Word: special link register    |
| SD    | Dddd   | 0~2047      | Word: special register         |
| Z     | Dd     | 0~19        | Word: index register           |

#### Melsec-E71

| Register name | Address format | Input range | Remarks                        |
|---------------|----------------|-------------|--------------------------------|
| X             | hhhh           | 0~1fff      | Bit: input relay, read only    |
| Y             | hhhh           | 0~1fff      | Bit: output relay              |
| M             | dddd           | 0~8191      | Bit: internal relay            |
| L             | dddd           | 0~8191      | Bit: latching relay            |
| F             | dddd           | 0~2047      | Bit: alarm relay               |
| V             | dddd           | 0~2047      | Bit: indexing relay            |
| S             | dddd           | 0~8191      | Bit: stepping relay            |
| B             | ffff           | 0~1fff      | Bit: conversion relay          |
| T             | ddd            | 0~2047      | Bit: status of timer           |
| C             | dddd           | 0~1023      | Bit: status of counter         |
| SB            | hhh            | 0~7ff       | Bit: special link relay        |
| SM            | ddd            | 0~2047      | Bit: special relay             |
| D_Bit         | Dddd.h         | 0.0~12287.f | Bit: bit of 16-bit register    |
| D             | Dddd           | 0~12287     | Word: data register            |
| W             | Hhhh           | 0~1fff      | Word: conversion register      |
| TV            | Dddd           | 0~2047      | Word: current value of timer   |
| CV            | Dddd           | 0~1023      | Word: current value of counter |
| SW            | Hhh            | 0~7ff       | Word: special link register    |
| SD            | Dddd           | 0~2047      | Word: special register         |
| Z             | Dd             | 0~19        | Word: index register           |

#### Melsec-LCPU

| 寄存器名称 | 地址格式 | 输入范围   | 备注                          |
|-------|------|--------|-----------------------------|
| X     | hhhh | 0~1fff | Bit: input relay, read only |
| Y     | hhhh | 0~1fff | Bit: output relay           |
| M     | dddd | 0~8191 | Bit: internal relay         |

---

|       |        |            |                                |
|-------|--------|------------|--------------------------------|
| L     | dddd   | 0~8191     | Bit: latching relay            |
| F     | dddd   | 0~2047     | Bit: alarm relay               |
| V     | dddd   | 0~2047     | Bit: indexing relay            |
| S     | dddd   | 0~8191     | Bit: stepping relay            |
| B     | hhhh   | 0~1fff     | Bit: conversion relay          |
| SB    | hhh    | 0~7ff      | Bit: special link relay        |
| T     | dddd   | 0~2047     | Bit: status of timer           |
| C     | dddd   | 0~1023     | Bit: status of counter         |
| D-bit | dddd.d | 0~45055.15 | Bit: bit of 16-bit register    |
| D     | dddd   | 0~45055    | Word: data register            |
| TV    | dddd   | 0~2047     | Word: current value of timer   |
| CV    | dddd   | 0~1023     | Word: current value of counter |
| W     | hhhh   | 0~1fff     | Word: conversion register      |
| SW    | hhh    | 0~7ff      | Word: special link register    |
| SD    | hhhh   | 0~2047     | Word: special register         |
| Z     | hh     | 0~19       | Word: index register           |

---

Note:

d represents decimal system, input range is 0-9;

o represents octal system, input range is 0-7;

h represents hexadecimal system, input range is 0-9, a-f;

Word in the remarks: represents the register can only be used as word;

Double-word in the remarks: represents that the data type of the register in configuration must be 32-bit;

Bit in the remarks: represents the register can only be used as bit;

Read only in the remarks represents that the register can only be read but not be written;

The names of the registers supported by different equipment model may be different, and the scopes may also be different.

For detailed name and scope, please consult related technical document of the connected device

---

#### 4. Instruction of connection between SK HMI and FX5U PLC of Mitsubishi Company

Open GX work3 Software-New file-Series FX5CPU-Type FX5U

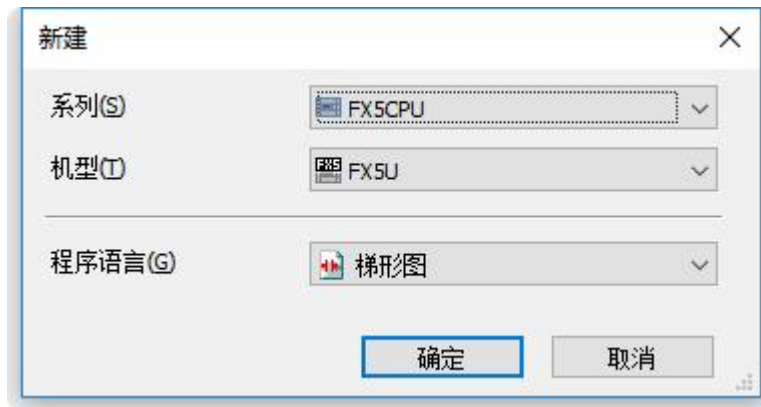

Navigation-Parameter-Module Parameter- Ethernet

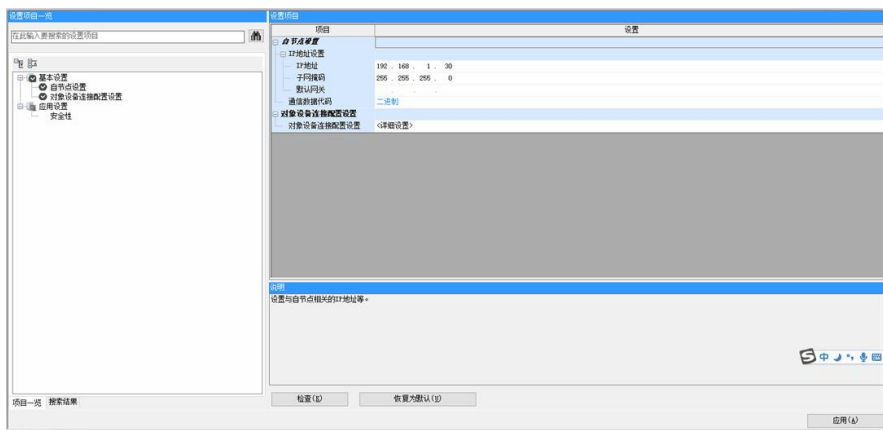

Object Link-Particular set

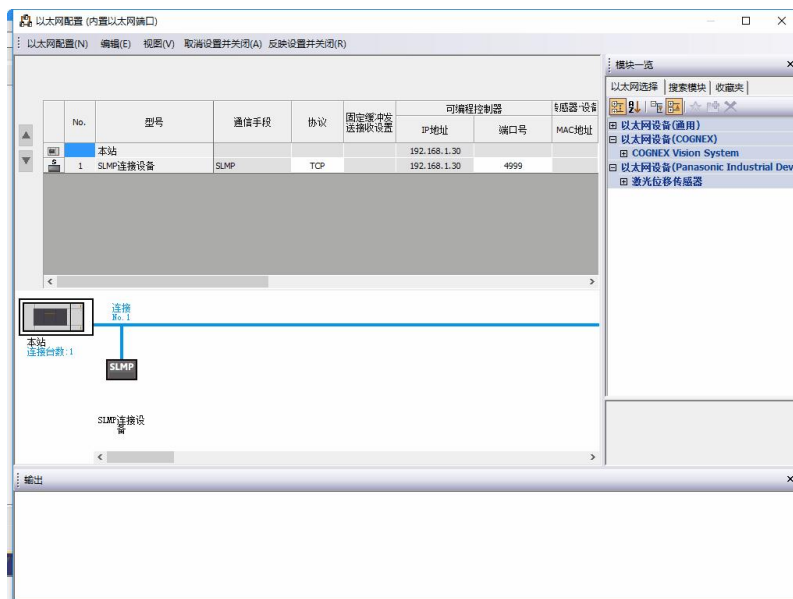

SKTOOL Software General

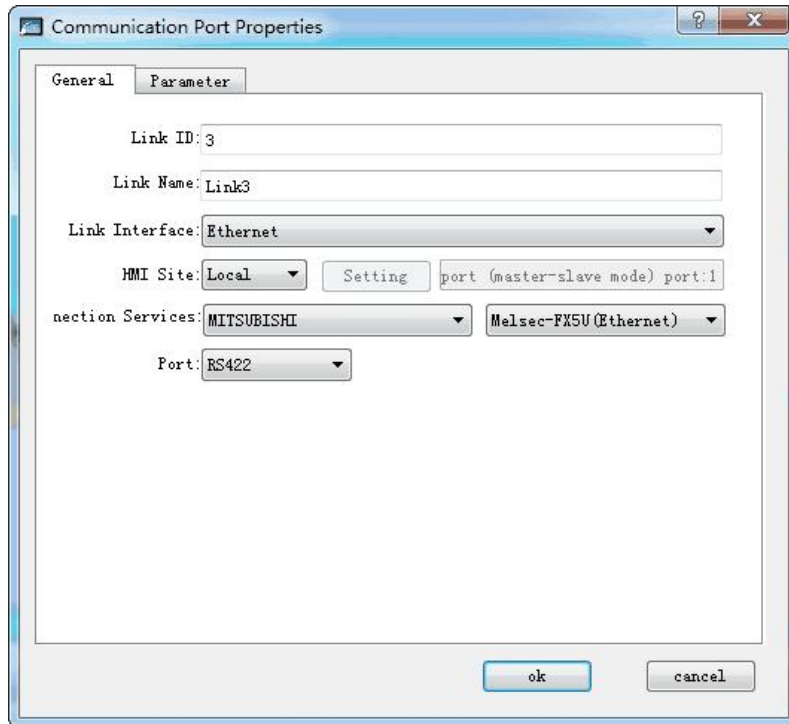

Link-Parameter

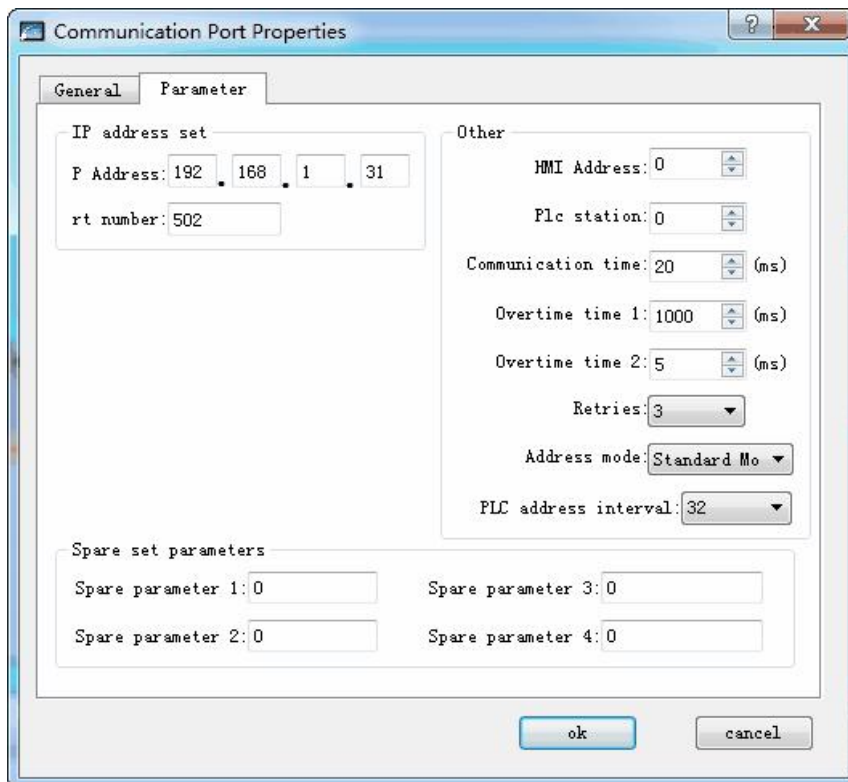

5. The touch screen connects to the FX2n 485BD module:

The PLC parameters are set as shown below



## 12.20 Modbus device driver

The device driver is used for SK HMI to read and write the data or state of MODBUS device. The serial communication connection is established through the serial port of the HMI series touch screen and the serial port of MODBUS device, so as to operate MODBUS device. Prior to use of the driver, please carefully read this chapter and the related technical specifications of the MODBUS series PLC device.

How to establish connection with MODBUS series PLC

Hardware connection

Connecting cable:

RS232

| SK HMI COM1/COM2 |     | Modbus device     |     |
|------------------|-----|-------------------|-----|
| 2                | RX  | User-defined pins | TX  |
| 3                | TX  | User-defined pins | RX  |
| 5                | GND | User-defined pins | GND |



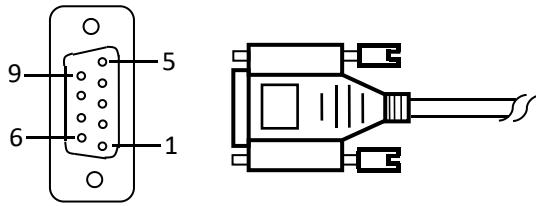

Terminal of HMI is DB9F. Definitions of Modbus device pins depend on particular Modbus device.

### RS422

| SK HMI COM1/COM2 |     | Modbus device     |     |
|------------------|-----|-------------------|-----|
| 6                | RX- | User-defined pins | TX- |
| 7                | RX+ | User-defined pins | TX+ |
| 8                | TX- | User-defined pins | RX- |
| 9                | TX+ | User-defined pins | RX+ |

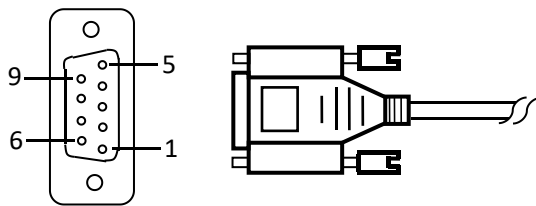

Terminal of HMI is DB9F. Definitions of Modbus device pins depend on particular Modbus device.

### RS485

| SK HMI COM1/COM2 |    | Modbus device     |   |
|------------------|----|-------------------|---|
| 8                | D- | User-defined pins | B |
| 9                | D+ | User-defined pins | A |

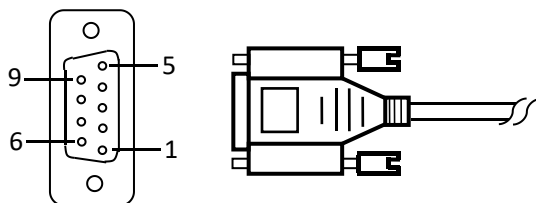

Terminal of HMI is a 9P trapezoidal female connector. Definitions of Modbus device pins depend on particular AIBUS device.

### TCP/IP (RJ45 direct connection)

| SK HMI COM1/COM2 |      | Modbus device |      |
|------------------|------|---------------|------|
| 1                | TX+  | 3             | RX+  |
| 2                | TX-  | 6             | RX-  |
| 3                | RX+  | 1             | TX+  |
| 4                | BD4+ | 4             | BD4+ |
| 5                | BD4- | 5             | BD4- |
| 6                | RX-  | 2             | TX-  |
| 7                | BD3+ | 7             | BD3+ |
| 8                | BD3- | 8             | BD3- |

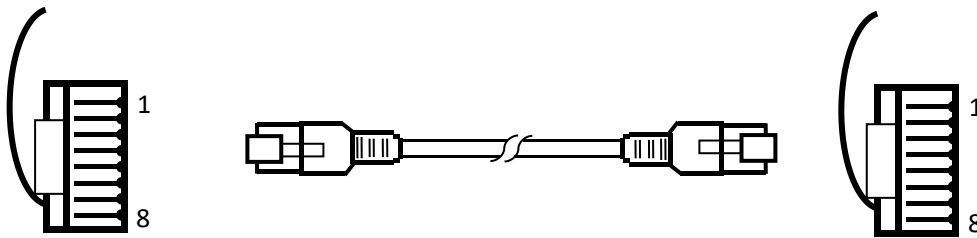

Terminal of HMI is RJ45, and that of Modbus device is RJ45.

#### TCP/IP (RJ45 connection via router)

| SK | HMI COM1/COM2 | Modbus device |      |
|----|---------------|---------------|------|
| 1  | TX+           | 3             | RX+  |
| 2  | TX-           | 6             | RX-  |
| 3  | RX+           | 1             | TX+  |
| 4  | BD4+          | 4             | BD4+ |
| 5  | BD4-          | 5             | BD4- |
| 6  | RX-           | 2             | TX-  |
| 7  | BD3+          | 7             | BD3+ |
| 8  | BD3-          | 8             | BD3- |

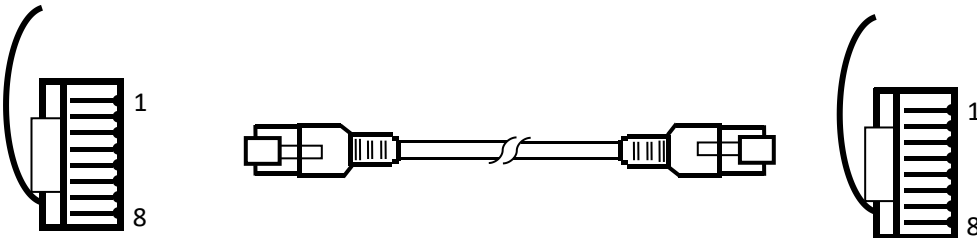

Terminal of HMI is RJ45, and that of Modbus device is RJ45.

### 1. Software settings

Select Modbus in connection device service.

Select the corresponding item in connection device service according to the connected PLC model or supported protocol.

Ensure that the communication parameters in touch screen connection parameters and PLC station number are consistent with the PLC connected.

For settings of the PLC connected, refer to the technical documents of the Modbus device.

#### Default connection parameters of SK HMI

| Setting item            | Default parameter value | Setting scope                                |
|-------------------------|-------------------------|--|
| PLC type                | RTU Master              | RTU/RTU_S/ASCII/ASCII_S Master               |
| Communication port type | RS232                   | RS232/RS422/RS485                            |
| Baud rate               | 9600                    | 1200/2400/4800/9600/19200/38400/57600/115200 |
| Data bit length         | 8                       | 7/8  |
| Parity bit              | NONE                    | EVEN/ODD/NONE                                |
| Stop bit length         | 1                       | 1/2  |
| PLC station number      | 1                       | 0~255  |
| HMI station number      | 0                       | 0~255  |

| Supporting function | Whether it is supported |
|---------------------|-------------------------|
| Off-line simulation | Yes                     |
| On-line simulation  | Yes                     |
| Extended mode       | Yes                     |

Note: The function code used in RTU\_S and ASCII\_S for data writing is 0x10 (regardless of length of the data written);

·If 0 is chosen for PLC station number, then the system is in broadcasting mode.

## 2. Operational register and address range

| Register name | Address format | Input range | Remarks                    |
|---------------|----------------|-------------|----------------------------|
| 0x            | dddd           | 0~65535     | Bit: input coil            |
| 1x            | dddd           | 0~65536     | Bit: input coil, read only |

|        |         |               |  |
|--------|---------|---------------|--|
| 3x_Bit | dddd.DD | 0.00~65535.15 | Bit: bit of 16-bit input register, read only   |
| 4x_Bit | dddd.DD | 0.00~65535.15 | Bit: bit of 16-bit output register   |
| 3x     | dddd    | 0~65535       | Word: 16-bit input register, read only   |
| 4x     | dddd    | 0~65535       | Word: 16-bit output register   |
| 3x_D   | dddd    | 0~65535       | Double word: input register, reversing the higher and lower 16 bits of 3x double word, read only |
| 4x_D   | dddd    | 0~65535       | Double word: output register, reversing the higher and lower 16 bits of 4x double word           |

Note:

d represents decimal system, input range is 0-9;

DD represents 16 bits, input range is 0-15;

Word in the remarks: represents the register can only be used as word;

Double-word in the remarks: represents that the data type of the register in configuration must be 32-bit;

Bit in the remarks: represents the register can only be used as bit;

Read only in the remarks represents that the register can only be read but not be written;

The names of the registers supported by different equipment models may be different, and the scopes may also be different.

For detailed name and scope, please consult related technical document of the connected device

Note:

Modbus rtu MCU is used to support standard modbus, such as single chip, converter, and other devices that require special processing. When the PLC address interval is set to 1, the register does not do any integration, and the data type length is read according to the control. When the width of the PLC address is greater than 2, the length of the read is the maximum amount of the actual PLC address interval. The bits address is in the position of j

## 12.21 Modicon device driver

The device driver is used for SK HMI to read and write the data or state of Modicon NEZA/TWIDO/M218 series PLC register. The serial communication connection is established through the serial port on the touch screen and the serial port of Modicon NEZA/TWIDO/M218 series PLC, so as to operate Modicon NEZA/TWIDO/M218 series PLC. Prior to use of the driver, one shall carefully read related technical specifications of the chapter and Modicon NEZA/TWIDO/M218 series PLC.

How to establish connection with Modicon NEZA/TWIDO/M218 series PLC

### 1. Hardware connection

Connecting cable:

RS485

| SK HMI COM1/COM2 |     | Modicon NEZA/TWIDO/M218 |     |
|------------------|-----|-------------------------|-----|
| 8                | TX- | 2                       | TX- |
| 9                | TX+ | 1                       | TX+ |
| 5                | GND | 7                       | GND |

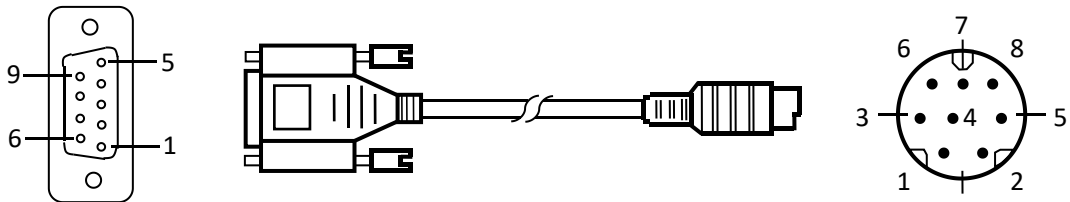

Terminal of HMI is DB9F, and that of Modicon NEZA/TWIDO/M218 series PLC is MD8M.

### 2. Software settings

Select Modicon Corp. in connection device service.

Select the corresponding item in connection device service according to the connected PLC model or supported protocol.

Ensure that the communication parameters in touch screen connection parameters and PLC station number are consistent with the PLC connected.

For settings of the PLC connected, refer to the technical documents of the Modicon NEZA/TWIDO/M218 series PLC.

Default connection parameters of SK HMI

| Setting item | Default parameter value | Setting scope |
|--------------|-------------------------|---------------|
|--------------|-------------------------|---------------|

|                         |             |  |
|-------------------------|-------------|--|
| PLC type                | NEZA Series | NEZA/TWIDO/M218 Series                       |
| Communication port type | RS232       | RS232/RS422/RS485                            |
| Baud rate               | 9600        | 1200/2400/4800/9600/19200/38400/57600/115200 |
| Data bit length         | 8           | 7/8  |
| Parity bit              | ODD         | EVEN/ODD/NONE                                |
| Stop bit length         | 1           | 1/2  |
| PLC station number      | 1           | 0~255  |
| HMI station number      | 0           | 0~255  |

| Supporting function | Whether it is supported |
|---------------------|-------------------------|
| Off-line simulation | Yes                     |
| On-line simulation  | Yes                     |
| Extended mode       | Yes                     |

### 3. Operational register and address range

#### NEZA Series

| Register name | Address format | Input range | Remarks                  |
|---------------|----------------|-------------|--------------------------|
| %MW           | dddd           | 0~65535     | Word: word data register |

#### TWIDO Series

| Register name | Address format | Input range | Remarks                  |
|---------------|----------------|-------------|--------------------------|
| %M            | dddd           | 0~65535     | Bit: bit data register   |
| %MW           | dddd           | 0~65535     | Word: word data register |

#### M218 Series

| Register name | Address format | Input range | Remarks                  |
|---------------|----------------|-------------|--------------------------|
| %MX           | dddd.o         | 0~131071.7  | Bit: bit data register   |
| %MW           | dddd           | 0~65535     | Word: word data register |

Note:

d represents decimal system, input range is 0-9;

o represents octal system, input range is 0-7;

Word in the remarks: represents the register can only be used as word;

Bit in the remarks: represents the register can only be used as bit;

---

The names of the registers supported by different equipment model may be different, and the scopes may also be different.

For detailed name and scope, please consult related technical document of the connected device

---

## 12.22 Nanda device driver

---

The device driver is used for SK HMI to read and write the data or state of Nanda NA-200/400 series PLC register. The serial communication connection is established through the serial port on the touch screen and the serial port of Nanda NA-200/400 series PLC, so as to operate Nanda NA-200/400 series PLC. Prior to use of the driver, one shall carefully read related technical specifications of the chapter and Nanda NA-200/400 series PLC.

How to establish connection with Nanda NA-200/400 series PLC

### 1. Hardware connection

Connecting cable:

RS232

| SK HMI COM1/COM2 |     | Nanda NA-200/400 |     |
|------------------|-----|------------------|-----|
| 2                | RX  | 3                | TX  |
| 3                | TX  | 2                | RX  |
| 5                | GND | 5                | GND |

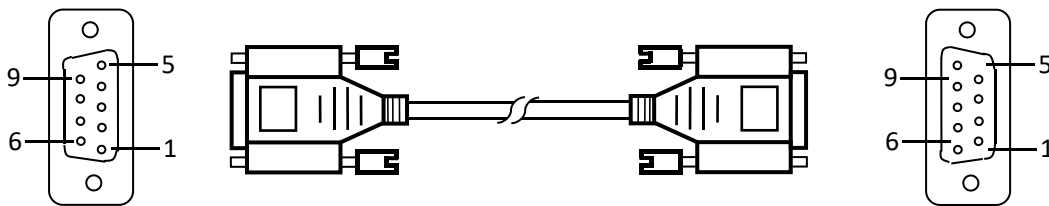

Terminal of HMI is DB9F, and that of Nanda NA-200/400 series PLC is DB9M.

### 2. Software settings

Select Nanda Auto Technology in connection device service.

Select the corresponding item in connection device service according to the connected PLC model or supported protocol.

Ensure that the communication parameters in touch screen connection parameters and PLC station number are consistent with the PLC connected.

For settings of the PLC connected, refer to the technical documents of the Nanda NA-200/400 series PLC.

#### Default connection parameters of SK HMI

| Setting item            | Default parameter value | Setting scope                                |
|-------------------------|-------------------------|--|
| PLC type                | Nanda NA-200            | Nanda NA-200/400                             |
| Communication port type | RS232                   | RS232/RS422/RS485                            |
| Baud rate               | 9600                    | 1200/2400/4800/9600/19200/38400/57600/115200 |
| Data bit length         | 8                       | 7/8  |
| Parity bit              | NONE                    | EVEN/ODD/NONE                                |
| Stop bit length         | 1                       | 1/2  |
| PLC station number      | 1                       | 0~255  |
| HMI station number      | 0                       | 0~255  |

| Supporting function | Whether it is supported |
|---------------------|-------------------------|
| Off-line simulation | Yes                     |
| On-line simulation  | Yes                     |
| Extended mode       | Yes                     |

### 3. Operational register and address range

#### Nanda NA-200

| Register name | Address format | Input range | Remarks  |
|---------------|----------------|-------------|--|
| I             | ddd            | 1~128       | Bit: digital quantity input, read only         |
| Q             | ddd            | 1~128       | Bit: digital quantity output                   |
| M             | dddd           | 1~1024      | Bit: bit register                              |
| S             | ddd            | 1~256       | Bit: system bit register                       |
| N             | ddd            | 1~256       | Bit: bit register for power failure protection |
| IW            | dd             | 1~32        | Word: analog quantity input                    |
| QW            | dd             | 1~32        | Word: analog quantity output                   |
| MW            | dddd           | 1~1024      | Word: word register                            |
| SW            | ddd            | 1~256       | Word: system word register                     |



---

|    |     |       |  |
|----|-----|-------|--|
| NW | ddd | 1~256 | Word: word register for power failure protection |
|----|-----|-------|--|

#### Nanda NA-400

| Register name | Address format | Input range | Remarks  |
|---------------|----------------|-------------|--|
| I             | ddd            | 1~2048      | Bit: digital quantity input, read only           |
| Q             | ddd            | 1~2048      | Bit: digital quantity output                     |
| M             | dddd           | 1~8192      | Bit: bit register                                |
| S             | ddd            | 1~4096      | Bit: system bit register                         |
| N             | ddd            | 1~2048      | Bit: bit register for power failure protection   |
| IW            | dd             | 1~512       | Word: analog quantity input                      |
| QW            | dd             | 1~512       | Word: analog quantity output                     |
| MW            | dddd           | 1~8192      | Word: word register                              |
| SW            | ddd            | 1~2048      | Word: system word register                       |
| NW            | ddd            | 1~2048      | Word: word register for power failure protection |

---

Note:

d represents decimal system, input range is 0-9;

Word in the remarks: represents the register can only be used as word;

Bit in the remarks: represents the register can only be used as bit;

Read only in the remarks represents that the register can only be read but not be written;

The names of the registers supported by different equipment model may be different, and the scopes may also be different.

For detailed name and scope, please consult related technical document of the connected device

---

## 12.23 Omron device driver

---

The device driver is used for SK HMI to read and write the data or state of SYSMAC C/CPM/CS/CJ

series PLC register. The serial communication connection is established through the serial port on the touch screen and the serial port of SYSMAC C/CPM/CS/CJ series PLC, so as to operate SYSMAC C/CPM/CS/CJ series PLC. Prior to use of the driver, one shall carefully read related technical specifications of the chapter and SYSMAC C/CPM/CS/CJ series PLC.

How to establish connection with SYSMAC C/CPM/CS/CJ series PLC

1. Hardware connection

Connecting cable:

RS232

| HMI series touch screen COM1/COM2 |     | SYSMAC CS/CJ |     |
|-----------------------------------|-----|--------------|-----|
| 2                                 | RX  | 2            | TX  |
| 3                                 | TX  | 3            | RX  |
| 5                                 | GND | 9            | GND |

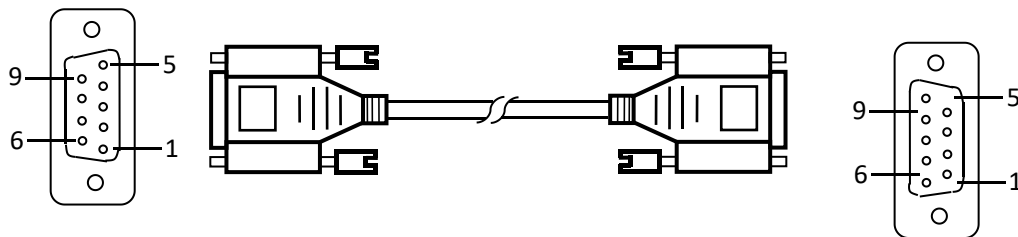

Terminal of HMI is DB9F, and that of SYSMAC C/CPM/CS/CJ series PLC is DB9M.

2. Software settings

Select OMRON in connection device service.

Select the corresponding item in connection device service according to the connected PLC model or supported protocol.

Ensure that the communication parameters in touch screen connection parameters and PLC station number are consistent with the PLC connected.

For settings of the PLC connected, please refer to the technical documents of the SYSMAC C/CPM/CS/CJ series PLC.

Default connection parameters of SK HMI

| Setting item | Default parameter value | Setting scope             |
|--------------|-------------------------|---------------------------|
| PLC type     | SYSMAC C/CPM            | SYSMAC C/CPM/CS/CJ Series |

|                         |        |  |
|-------------------------|--------|--|
|                         | Series |  |
| Communication port type | RS232  | RS232/RS422/RS485                            |
| Baud rate               | 9600   | 1200/2400/4800/9600/19200/38400/57600/115200 |
| Data bit length         | 7      | 7/8  |
| Parity bit              | EVEN   | EVEN/ODD/NONE                                |
| Stop bit length         | 2      | 1/2  |
| PLC station number      | 0      | 0~255  |
| HMI station number      | 0      | 0~255  |

| Supporting function | Whether it is supported |
|---------------------|-------------------------|
| Off-line simulation | Yes                     |
| On-line simulation  | Yes                     |
| Extended mode       | No                      |

### 3. Operational register and address range

#### SYSMAC C/CPM Series

| Register name | Address format | Input range | Remarks                      |
|---------------|----------------|-------------|------------------------------|
| IR_Bit        | dddd.DD        | 0.0~4095.15 | Bit: input/output relay      |
| HR_Bit        | dddd.DD        | 0.0~4095.15 | Bit: hold relay              |
| LR_Bit        | dddd.DD        | 0.0~4095.15 | Bit: link relay              |
| AR_Bit        | dddd.DD        | 0.0~4095.15 | Bit: auxiliary memory relay  |
| T             | ddd            | 0~255       | Bit: status of timer         |
| C             | ddd            | 0~255       | Bit: status of counter       |
| IR            | dddd           | 0~4095      | Word: input/output relay     |
| HR            | dddd           | 0~4095      | Word: hold relay             |
| LR            | dddd           | 0~4095      | Word: link relay             |
| AR            | dddd           | 0~4095      | Word: auxiliary memory relay |
| TC            | ddd            | 0~255       | Word: value of timer         |
| DM            | dddd           | 0~9999      | Word: common data area       |

#### SYSMAC CS/CJ Series

| Register name | Address format | Input range | Remarks   |
|---------------|----------------|-------------|---|
| CIO_Bit       | dddd.DD        | 0.0~3189.15 | Bit: core I/O area  |
| W_Bit         | dddd.DD        | 0.0~6143.15 | Bit: work area  |
| H_Bit         | dddd.DD        | 0.0~511.15  | Bit: holding area   |
| A_Bit         | dddd.DD        | 0.0~959.15  | Bit: auxiliary area, read only:<br>7,168Bit: A00000~A447.15 |

|       |         |              |   |
|-------|---------|--------------|---|
| D_Bit | dddd.DD | 0.0~32767.15 | Bit: common data area                               |
| T     | dddd    | 0~4095       | Bit: status of timer                                |
| C     | dddd    | 0~4095       | Bit: status of counter                              |
| CIO   | dddd    | 0~3189       | Word: core I/O area                                 |
| W     | dddd    | 0~6143       | Word: work area                                     |
| H     | dddd    | 0~511        | Word: holding area                                  |
| A     | dddd    | 0~959        | Word: auxiliary area, read only: 448Word: A000~A447 |
| D     | dddd    | 0~32767      | Word: common data area                              |
| TV    | dddd    | 0~4095       | Word: current value of timer                        |
| CV    | dddd    | 0~4095       | Word: current value of counter                      |

#### CP1L Tcp/Ip / Fins-udp

| Register name | Address format | Input range  | Remarks  |
|---------------|----------------|--------------|--|
| CIO_Bit       | dddd.DD        | 0.0~3189.15  | Bit: core I/O area                                       |
| W_Bit         | dddd.DD        | 0.0~6143.15  | Bit: work area   |
| H_Bit         | dddd.DD        | 0.0~511.15   | Bit: holding area  |
| A_Bit         | dddd.DD        | 0.0~959.15   | Bit: auxiliary area, read only: 7,168Bit: A00000~A447.15 |
| D_Bit         | dddd.DD        | 0.0~32767.15 | Bit: common data area                                    |
| T             | dddd           | 0~4095       | Bit: status of timer                                     |
| C             | dddd           | 0~4095       | Bit: status of counter                                   |
| CIO           | dddd           | 0~3189       | Word: core I/O area                                      |
| W             | dddd           | 0~6143       | Word: work area  |
| H             | dddd           | 0~511        | Word: holding area                                       |
| A             | dddd           | 0~959        | Word: auxiliary area, read only: 448Word: A000~A447      |
| D             | dddd           | 0~32767      | Word: common data area                                   |
| TV            | dddd           | 0~4095       | Word: current value of timer                             |
| CV            | dddd           | 0~4095       | Word: current value of counter                           |

Note:

d represents decimal system, input range is 0-9;

DD represents 16 bits; input range is 0-15;

Word in the remarks: represents the register can only be used as word;

Bit in the remarks: represents the register can only be used as bit;

---

Read only in the remarks represents that the register can only be read but not be written;

The names of the registers supported by different equipment model may be different, and the scopes may also be different.

For detailed name and scope, please consult related technical documents of the connected device

---

Cp1l tcp/ip connection specificationSet

the -> built-in Ethernet -> set IP and port numberNote:

the proposed use of fins-udp communications, which can be connected to the same PLC in multiple touchscreens, and the need for a handshake connection before normal communication requires a certain amount of time

Fins-udp connection instructions:

Set the -> built-in Ethernet -> set IP and port number

The number of the number of nodes in the fins-udp configuration is consistent with the node number in the ohmlong Ethernet Settings option

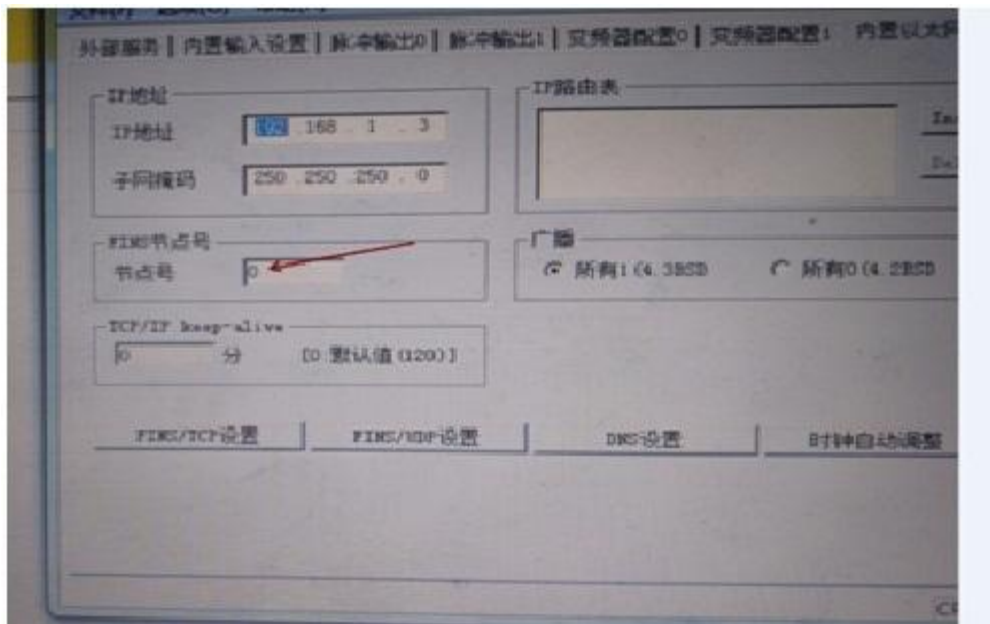

## 12.24 Siemens device driver

---

The device driver is used for SK HMI to read and write the data or state of Siemens S7-200/300/1200 series PLC register. The serial communication connection is established through the serial port on the touch screen and the serial port of Siemens S7-200/300 /1200tcp series PLC, so as to operate Siemens S7-200/300/1200tcp series PLC. Prior to use of the driver, one shall carefully read related technical specifications of the chapter and Siemens S7-200/300/1200tcp series PLC.

How to establish connection with Siemens S7-200/300/1200tcp series PLC

### 1. 1 Hardware connection

Connecting cable:

RS485-Siemens S7-200

| SK HMI COM1/COM2 |     | Siemens S7-200 series |     |
|------------------|-----|-----------------------|-----|
| 8                | TX- | 8                     | TX- |
| 9                | TX+ | 3                     | TX+ |

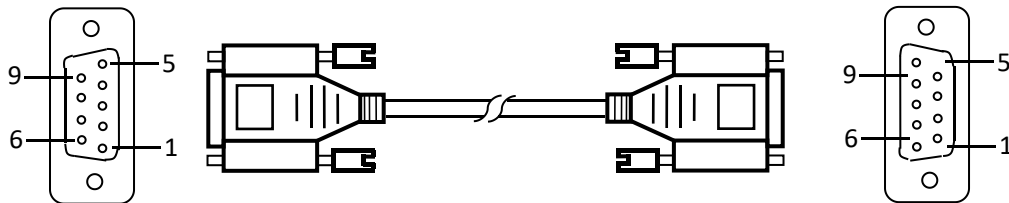

RS232-Siemens S7-300

| SK HMI COM1/COM2 |     | Siemens S7-300 series |     |
|------------------|-----|-----------------------|-----|
| 2                | RX  | 3                     | TX  |
| 3                | TX  | 2                     | RX  |
| 5                | GND | 5                     | GND |

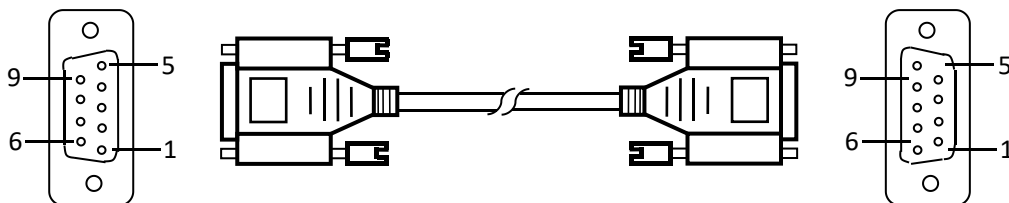

Terminal of HMI is DB9F, and that of Siemens S7-300 series PLC MPI is DB9M.

How to establish connection with Siemens S7-200/300/1200 series PLC

### 1. 2 Hardware connection

Connecting cable:

Cable RJ45;

Pins of RJ45:

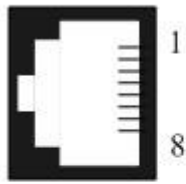

|   |      |
|---|------|
| 1 | TX+  |
| 2 | TX-  |
| 3 | RX+  |
| 4 | BD4+ |
| 5 | BD4- |
| 6 | RX-  |
| 7 | BD3+ |
| 8 | BD3- |

#### Settings of IP and Port Number

Select "Ethernet Port" for Connection Interface in General page of Communication Port Properties and "SIEMENS", "Siemens S7-200(TCP/IP)/Siemens S7-300(TCP/IP)/Siemens S7-1200(TCP)" for Connection Services;

In the Parameter page of Communication Port Properties, set the IP and Port number.

Notice:

Addresses of PLC and IP must be under the same subnet with HMI, i.e. it only needs to set the subnet mask to 255.255.255.0.

In the settings of Siemens-1200 PLC, it is necessary to ensure whether the PLC has the protection function of connection; check the particular option if necessary after then recompile and download it to PLC.

Upload the PLC program or create a new one of Simens\_1200 in the software of TIA Portal; right click the item and select "Property"; check "Permit communication access of PUT/GET to remote partners (PLC、HMI、OPC...)" in "Protection", as shown in the figure below:

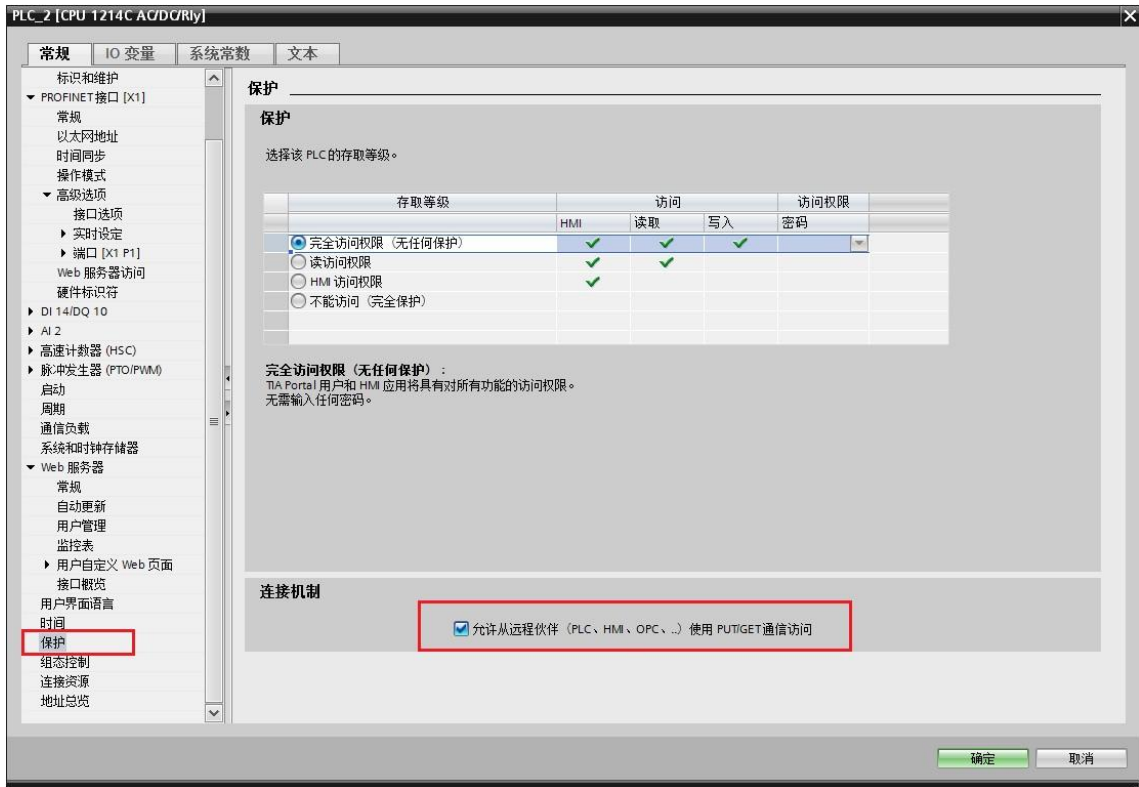

## 2. Software Settings

Select SIEMENS in connection device service.

Select the corresponding item in connection device service according to the connected PLC model or supported protocol.

Guarantee that communication parameters in touch screen connection parameters and PLC station number are consistent with the connected PLC.

For settings of the connected PLC, please consult related technical documents of Siemens S7-200/300 series PLC

Default connection parameters of SK HMI

| Setting item            | Default parameter value | Setting scope                                |
|-------------------------|-------------------------|--|
| PLC type                | S7-200(PPI)             | S7-200(PPI)/ S7-300(MPI)                     |
| Communication port type | RS485                   | RS232/RS422/RS485                            |
| Baud rate               | 19200                   | 1200/2400/4800/9600/19200/38400/57600/115200 |
| Data bit length         | 8                       | 7/8  |
| Parity bit              | EVEN                    | EVEN/ODD/NONE                                |



|                     |                                    |          |
|---------------------|------------------------------------|----------|
| Stop bit length     | 1                                  | 1/2      |
| PLC station number  | 2                                  | 1 to 255 |
| HMI station number  | 0                                  | 0 to 255 |
| Supporting function | Whether it is supported            |          |
| Off-line simulation | Yes                                |          |
| On-line simulation  | Yes                                |          |
| Extended mode       | Yes: S7-200(PPI)/ No.: S7-300(MPI) |          |

### 3. Operational register and address range

Siemens S7-200/ Siemens S7-200 tcp

| Register name | Address format | Input range    | Remarks  |
|---------------|----------------|----------------|--|
| I             | dd.o           | 0.0 to 4095.7  | Bit: input shadow register, read only  |
| Q             | dd.o           | 0.0 to 4095.7  | Bit: output shadow register  |
| M             | dd.o           | 0.0 to 4095.7  | Bit: bit memory  |
| S             | dd.o           | 0.0 to 4095.7  | Bit: sequence control relay  |
| SM            | ddd.o          | 0.0 to 4095.7  | Bit: special bit memory, SM0.0-SM29.7 read only  |
| T             | ddd            | 0 to 255       | Bit: timer state: read only  |
| C             | ddd            | 0 to 255       | Bit: counter state: read only  |
| VB_Bit        | dddd.o         | 0.0 to 10239.7 | Bit: variable memory bit   |
| IW            | dd             | 0 to 4095      | Word: input shadow register, read only, 8-digit register, each word occupies two addresses         |
| QW            | dd             | 0 to 4095      | Word: output shadow register, 8-digit register, each word occupies two addresses                   |
| MW            | dd             | 0 to 4095      | Word: bit memory, 8-digit register, each word occupies two addresses                               |
| SW            | dd             | 0 to 4095      | Word: sequence control relay, 8-digit register, each word occupies two addresses                   |
| SMW           | ddd            | 0 to 4095      | Word: special bit memory, SMW0-SMW29 read only, 8-digit register, each word occupies two addresses |
| VB            | dddd           | 0 to 10239     | Word: variable memory, 8-digit register  |

|     |      |            |  |
|-----|------|------------|--|
| VW  | dddd | 0 to 10238 | Word: variable memory, 8-digit register, each word occupies two addresses                |
| VD  | dddd | 0 to 10236 | Double-word: variable memory, 8-digit register, each double-word occupies four addresses |
| TV  | ddd  | 0 to 255   | Word: current value of the timer   |
| CV  | ddd  | 0 to 255   | Word: current value of the counter   |
| AIW | dd   | 0 to 62    | Word: analog input, read only, 8-digit register, each word occupies two addresses        |
| AQW | dd   | 0 to 62    | Word: analog output, write only, 8-digit register, each word occupies two addresses      |
| ID  | dddd | 0~4092     | Binary word: input image register  |
| QD  | dddd | 0~4092     | Binary word: output image register   |
| MD  | dddd | 0~4092     | Word memory  |
| SD  | dddd | 0~4092     | Double word: sequence control relay  |
| SMD | dddd | 0~4092     | Double word: special memory  |

Siemens S7-300 / Siemens S7-300(MPI) / Siemens S7-300tcp

| Register name | Address format | Input range         | Remarks   |
|---------------|----------------|---------------------|---|
| I             | dddd.o         | 0.0 to 4095.7       | Bit: input shadow register  |
| Q             | dddd.o         | 0.0 to 4095.7       | Bit: output shadow register   |
| M             | dddd.o         | 0.0 to 4095.7       | Bit: bit memory   |
| DB_Bit        | DDD:dddd.o     | 0:0.0 to 255:8192.7 | Bit: bit of word of DB block storage area, block number DD 0 to 255, word of each block dddd 0 to 8192, bit of each word o 0 to 7           |
| IW            | dddd           | 0 to 4095           | Word: input shadow register, 8-digit register, each word occupies two addresses   |
| QW            | dddd           | 0 to 4095           | Word: output shadow register, 8-digit register, each word occupies two addresses  |
| MW            | dddd           | 0 to 4095           | Word: bit memory, 8-digit register, each word occupies two addresses  |
| DBW           | DDD:dddd       | 0:0 to 255:8192     | Word: DB block storage area, block number DD 0 to 255, word of each word dddd 0 to 8192, 8-digit register, each word occupies two addresses |

|     |          |                 |  |
|-----|----------|-----------------|--|
| DBD | DDD:dddd | 0:0 to 255:8192 | Double word: DB block storage area, block number DD 0 to 255, word of each word dddd 0 to 8192, 8-digit register, each double-work occupies four addresses |
| ID  | dddd     | 0~4092          | Binary word: input image register  |
| QD  | dddd     | 0~4092          | Binary word: output image register   |
| MD  | dddd     | 0~4092          | Double word: auxiliary memory  |

#### Siemens S7-1200tcp

| Register name | Address format | Input range      | Remarks  |
|---------------|----------------|------------------|--|
| I             | dddd.o         | 0.0~1024.7       | Bit: input shadow register   |
| Q             | dddd.o         | 0.0~1024.7       | Bit: output shadow register  |
| M             | dddd.o         | 0.0~8191.7       | Bit: bit memory  |
| DB_Bit        | DDD:dddd.o     | 0:0.0~255:8192.7 | Bit: bit of word of DB block storage area, block number DD 0 to 255, word of each block dddd 0 to 8192, bit of each word o 0 to 7                          |
| IW            | dddd           | 0~1024           | Word: input shadow register, 8-digit register, each word occupies two addresses  |
| QW            | dddd           | 0~1024           | Word: output shadow register, 8-digit register, each word occupies two addresses   |
| MW            | dddd           | 0~8191           | Word: bit memory, 8-digit register, each word occupies two addresses   |
| DBW           | DDD:dddd       | 0:0~255:8192     | Word: DB block storage area, block number DD 0 to 255, word of each word dddd 0 to 8192, 8-digit register, each word occupies two addresses                |
| DBD           | DDD:dddd       | 0:0~255:8192     | Double word: DB block storage area, block number DD 0 to 255, word of each word dddd 0 to 8192, 8-digit register, each double-work occupies four addresses |
| ID            | dddd           | 0~1021           | Binary word: input image register  |
| QD            | dddd           | 0~1021           | Binary word: output image register   |
| MD            | dddd           | 0~8188           | Double word: auxiliary memory  |

#### LOGO\_TCP

| Register name | Address format | Input range | Remarks                    |
|---------------|----------------|-------------|----------------------------|
| I             | dd             | 1~64        | Bit: input shadow register |

---

|    |        |            |                              |
|----|--------|------------|------------------------------|
| Q  | dd     | 1~64       | Bit: output shadow register  |
| M  | ddd    | 1~112      | Bit: bit memory              |
| VB | dddd.o | 0.0~1023.7 | Bit                          |
| AI | dd     | 1~16       | Word: input shadow register  |
| AQ | dd     | 1~16       | Word: output shadow register |
| AM | dd     | 1~64       | Word: bit memory             |
| VW | dddd   | 0~511      | Word                         |

---

Note:

d represents decimal system, input range is 0-9;

o represents octal system, input range is 0-7;

DDD represents block number; input range is 0-255;

Word in the remarks: represents the register can only be used as word;

Double-word in the remarks: represents that the data type of the register in configuration must be 32-bit;

Bit in the remarks: represents the register can only be used as bit;

Read only in the remarks represents that the register can only be read but not be written;

The names of the registers supported by different equipment model may be different, and the scopes may also be different.

For detailed name and scope, please consult related technical document of the connected device

---

## 12.25 TaiAn device driver

---

The device driver is used for SK HMI to read and write the data or state of TaiAn TP03 series PLC register. The serial communication connection is established through the serial port on the touch screen and the serial port of TaiAn TP03 series PLC, so as to operate TaiAn TP03 series PLC. Prior to use of the driver, one shall carefully read the chapter and related technical specifications of TaiAn TP03 series PLC.

How to establish connection with HOLLYSYS series PLC

1. Hardware connection

Connecting cable:

RS232

| SK HMI COM1/COM2 |     | TaiAn TP03 series |     |
|------------------|-----|-------------------|-----|
| 2                | RX  | 3                 | TX  |
| 3                | TX  | 2                 | RX  |
| 5                | GND | 5                 | GND |

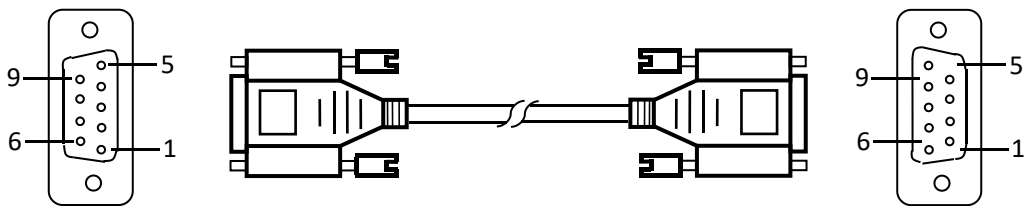

Terminal of HMI series touch screen is DB9F, and that of TaiAn TP03 series PLC is DB9M.

2. Software settings

Select TaiAn Technology in connection device service.

Select the corresponding item in connection device service according to the connected PLC model or supported protocol.

Guarantee that communication parameters in touch screen connection parameters and PLC station number are consistent with the connected PLC.

For setting of the connected PLC, please consult related technical documents of TaiAn TP03 series PLC.

Default connection parameters of SK HMI

| Setting item            | Default parameter value | Setting scope                                |
|-------------------------|-------------------------|--|
| PLC type                | TP03 Series             | TP03 Series                                  |
| Communication port type | RS232                   | RS232/RS422/RS485                            |
| Baud rate               | 19200                   | 1200/2400/4800/9600/19200/38400/57600/115200 |
| Data bit length         | 8                       | 7/8  |
| Parity                  | NONE                    | EVEN/ODD/NONE                                |

|                    |   |          |
|--------------------|---|----------|
| Stop bit length    | 2 | 1/2      |
| PLC station number | 1 | 0 to 255 |
| HMI station number | 0 | 0 to 255 |

| Supporting function | Whether it is supported |
|---------------------|-------------------------|
| Offline simulation  | Yes                     |
| Online simulation   | Yes                     |
| Extended mode       | Yes                     |

### 3. Operational register and address scope

| Register name | Address format | Input scope  | Remarks                                   |
|---------------|----------------|--------------|---|
| X             | ooo            | 0 to 377     | Bit: input relay, read only               |
| Y             | ooo            | 0 to 377     | Bit: output relay                         |
| M             | dddd           | 0 to 7999    | Bit: auxiliary relay                      |
| SM            | dddd           | 8000 to 8511 | Bit: special auxiliary relay              |
| S             | dddd           | 0 to 4095    | Bit: stepping relay                       |
| T             | ddd            | 0 to 511     | Bit: timer                                |
| C             | ddd            | 0 to 255     | Bit: counter                              |
| D             | dddd           | 0 to 7999    | Word: data register                       |
| SD            | dddd           | 8000 to 8511 | Word: special data register               |
| TV            | ddd            | 0 to 511     | Word: current value of the timer          |
| CV            | ddd            | 0 to 199     | Word: current value of the counter        |
| CV32          | ddd            | 200 to 255   | Double-word: current value of the counter |

Note:

d represents decimal system, input scope is 0-9;

o represents octal system, input scope is 0-7;

Word in the remarks: represents the register can only be used as word;

Double-word in the remarks: represents that the data type of the register in configuration must be 32-bit;

Bit in the remarks: represents the register can only be used as bit;

Read only in the remarks represents that the register can only be read but not be written;

---

The names of the registers supported by different equipment model may be different, and the scopes may also be different;

For detailed name and scope, please consult related technical document of the connected device.

---

## 12.26 TailLing device driver

---

The device driver is used for SK HMI to read and write the data or state of TailLing DX series PLC register. The serial communication connection is established through the serial port on the touch screen and the serial port of TailLing DX series PLC, so as to operate TailLing DX series PLC. Prior to use of the driver, one shall carefully read related technical specifications of the chapter and TailLing DX series PLC.

How to establish connection with TailLing DX series PLC

### 1. Hardware connection

Connecting cable:

RS232 (serial port RS232 protocol)

| SK HMI COM1/COM2 |     | TailLing DX series |     |
|------------------|-----|--------------------|-----|
| 2                | RX  | 3                  | TX  |
| 3                | TX  | 2                  | RX  |
| 5                | GND | 5                  | GND |

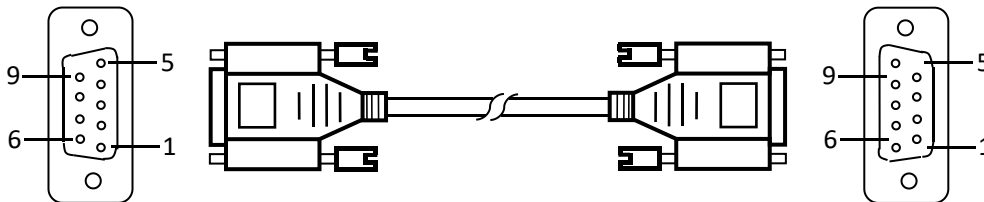

Terminal of HMI is DB9F, and that of TailLing DX series PLC is DB9M.

### 2. Software settings

Select TailLing Electric in connection device service.

Select the corresponding item in connection device service according to the connected PLC model

or supported protocol.

Guarantee that communication parameters in touch screen connection parameters and PLC station number are consistent with the connected PLC.

For setting of the connected PLC, please consult related technical documents of Siemens TaiLing DX series PLC.

#### Default connection parameters of SK HMI

| Setting item            | Default parameter value | Setting scope                                |
|-------------------------|-------------------------|--|
| PLC type                | DX Series               | DX Series                                    |
| Communication port type | RS232                   | RS232/RS422/RS485                            |
| Baud rate               | 9600                    | 1200/2400/4800/9600/19200/38400/57600/115200 |
| Data bit length         | 8                       | 7/8  |
| Parity                  | NONE                    | EVEN/ODD/NONE                                |
| Stop bit length         | 1                       | 1/2  |
| PLC station number      | 1                       | 1 to 31                                      |
| HMI station number      | 0                       | 0 to 255                                     |

| Supporting function | Whether it is supported |
|---------------------|-------------------------|
| Offline simulation  | Yes                     |
| Online simulation   | Yes                     |
| Extended mode       | No                      |

### 3. Operational register and address scope

| Register name | Address format | Input scope  | Remarks                          |
|---------------|----------------|--------------|----------------------------------|
| X             | oooo           | 0 to 377     | Bit: input coil, read only       |
| Y             | oooo           | 0 to 377     | Bit: output coil                 |
| M             | dddd           | 0 to 7999    | Bit: intermediate relay          |
| SM            | dddd           | 8000 to 8999 | Bit: special intermediate relay  |
| S             | dddd           | 0 to 999     | Bit: state bit                   |
| T             | dddd           | 0 to 256     | Bit: timer state                 |
| C             | dddd           | 0 to 256     | Bit: counter state               |
| D             | dddd           | 0 to 7999    | Word: register                   |
| SD            | dddd           | 8000 to 8999 | Word: special register           |
| TV            | dddd           | 0 to 255     | Word: current value of the timer |



|      |      |            |  |
|------|------|------------|--|
| CV   | dddd | 0 to 199   | Word: current value of the counter           |
| CV32 | dddd | 200 to 255 | Double-word: current value of 32-bit counter |

Note:

d represents decimal system, input scope is 0-9;

o represents octal system, input scope is 0-7;

Word in the remarks: represents the register can only be used as word;

Double-word in the remarks: represents that the data type of the register in configuration must be 32-bit;

Bit in the remarks: represents the register can only be used as bit;

Read only in the remarks represents that the register can only be read but not be written;

The names of the registers supported by different equipment model may be different, and the scopes may also be different;

For detailed name and scope, please consult related technical document of the connected device.

## 12.27 Techwayson device driver

The device driver is used for SK HMI to read and write the data or state of TaiLing DX series PLC register. The serial communication connection is established through the serial port on the touch screen and the serial port of TaiLing DX series PLC, so as to operate TaiLing DX series PLC. Prior to use of the driver, one shall carefully read related technical specifications of the chapter and TaiLing DX series PLC.

How to establish connection with TaiLing DX series PLC

### 1. Hardware connection

Connecting cable:

RS232 (serial port RS232 protocol)



|   |     |   |     |
|---|-----|---|-----|
| 2 | RX  | 3 | TX  |
| 3 | TX  | 2 | RX  |
| 5 | GND | 5 | GND |

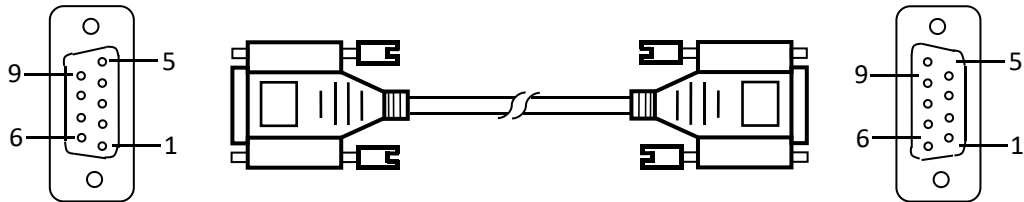

Terminal of HMI is DB9F, and that of TaiLing DX series PLC is MD8M.

## 2. Software settings

Select TaiLing Electric in connection device service.

Select the corresponding item in connection device service according to the connected PLC model or supported protocol.

Guarantee that communication parameters in touch screen connection parameters and PLC station number are consistent with the connected PLC.

For setting of the connected PLC, please consult related technical documents of Siemens TaiLing DX series PLC.

Default connection parameters of SK HMI

| Setting item            | Default parameter value | Setting scope                                |
|-------------------------|-------------------------|--|
| PLC type                | Techwayson V80 Series   | Techwayson V80 Series                        |
| Communication port type | RS232                   | RS232  |
| Baud rate               | 19200                   | 1200/2400/4800/9600/19200/38400/57600/115200 |
| Data bit length         | 8                       | 7/8  |
| Parity                  | EVEN                    | EVEN/ODD/NONE                                |
| Stop bit length         | 1                       | 1/2  |
| PLC station number      | 1                       | 0~255  |
| HMI station number      | 0                       | 0~255  |

| Supporting | Whether it is supported |
|------------|-------------------------|
|------------|-------------------------|

| function           |     |
|--------------------|-----|
| Offline simulation | Yes |
| Online simulation  | Yes |
| Extended mode      | Yes |

### 3. Operational register and address scope

| Register name | Address format | Input scope  | Remarks                                      |
|---------------|----------------|--------------|--|
| X             | oooo           | 0 to 377     | Bit: input coil, read only                   |
| Y             | oooo           | 0 to 377     | Bit: output coil                             |
| M             | dddd           | 0 to 7999    | Bit: intermediate relay                      |
| SM            | dddd           | 8000 to 8999 | Bit: special intermediate relay              |
| S             | dddd           | 0 to 999     | Bit: state bit                               |
| T             | dddd           | 0 to 256     | Bit: timer state                             |
| C             | dddd           | 0 to 256     | Bit: counter state                           |
| D             | dddd           | 0 to 7999    | Word: register                               |
| SD            | dddd           | 8000 to 8999 | Word: special register                       |
| TV            | dddd           | 0 to 255     | Word: current value of the timer             |
| CV            | dddd           | 0 to 199     | Word: current value of the counter           |
| CV32          | dddd           | 200 to 255   | Double-word: current value of 32-bit counter |

| Register name | Address format | Input scope | Remarks                                |
|---------------|----------------|-------------|--|
| 0x            | dddd           | 1~9984      | Bit: output coil                       |
| 1x            | dddd           | 1~2048      | Bit: input coil, read only             |
| 3x            | dddd           | 1~512       | Word: 16-bit input register, read only |
| 4x            | dddd           | 1~9999      | Word: 16-bit holding register          |

Note:

d represents decimal system, input scope is 0-9;

o represents octal system, input scope is 0-7;

Word in the remarks: represents the register can only be used as word;

Double-word in the remarks: represents that the data type of the register in configuration must be 32-bit;

Bit in the remarks: represents the register can only be used as bit;

---

Read only in the remarks represents that the register can only be read but not be written;

The names of the registers supported by different equipment model may be different, and the scopes may also be different.

For detailed name and scope, please consult related technical document of the connected device

---

## 12.28 Vigor device driver

---

The device driver is used for SK HMI to read and write the data or state of Vigor V/VH/VB/M series PLC register. The serial communication connection is established through the serial port on the touch screen and the serial port of Vigor V/VH/VB/M series PLC, so as to operate Vigor V/VH/VB/M series PLC. Prior to use of the driver, one shall carefully read related technical specifications of the chapter and Vigor V/VH/VB/M series PLC.

How to establish connection with Vigor V/VH/VB/M series PLC

### 1. Hardware connection

Connecting cable:

RS232

| SK HMI COM1/COM2 |     | Vigor V/VH/VB/M series |     |
|------------------|-----|------------------------|-----|
| 2                | RX  | 3                      | TX  |
| 3                | TX  | 2                      | RX  |
| 5                | GND | 4                      | GND |

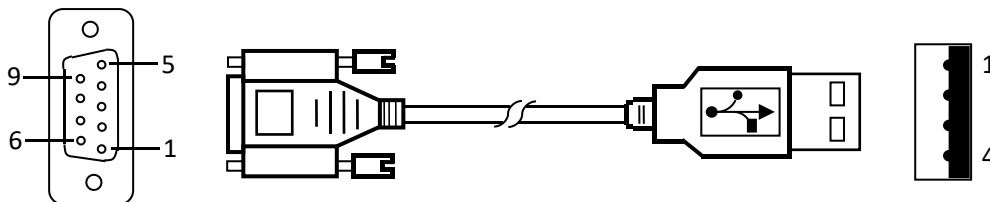

Terminal of HMI is DB9F, and that of Vigor V/VH/VB/M series PLC is DB9M.

### 2. Software settings

Select Vigor Electric Corp. in connection device service.

Select the corresponding item in connection device service according to the connected PLC model or supported protocol.

Guarantee that communication parameters in touch screen connection parameters and PLC station number are consistent with the connected PLC.

For settings of the connected PLC, please consult related technical documents of Vigor V/VH/VB/M series PLC.

#### Default connection parameters of SK HMI

| Setting item            | Default parameter value | Setting scope                                |
|-------------------------|-------------------------|--|
| PLC type                | V/VH/VB/M Series        | V/VH/VB/M Series                             |
| Communication port type | RS232                   | RS232/RS422/RS485                            |
| Baud rate               | 19200                   | 1200/2400/4800/9600/19200/38400/57600/115200 |
| Data bit length         | 7                       | 7/8  |
| Parity                  | EVEN                    | EVEN/ODD/NONE                                |
| Stop bit length         | 1                       | 1/2  |
| PLC station number      | 0                       | 0 to 255                                     |
| HMI station number      | 0                       | 0 to 255                                     |

| Supporting function | Whether it is supported |
|---------------------|-------------------------|
| Offline simulation  | Yes                     |
| Online simulation   | Yes                     |
| Extended mode       | No                      |

### 3. Operational register and address scope

| Register name | Address format | Input scope  | Remarks                          |
|---------------|----------------|--------------|----------------------------------|
| X             | ooo            | 0 to 777     | Bit: input contact               |
| Y             | ooo            | 0 to 777     | Bit: output contact              |
| M             | dddd           | 0 to 8999    | Bit: internal relay              |
| SM            | dddd           | 9000 to 9255 | Bit: special internal relay      |
| S             | dddd           | 0 to 999     | Bit: stepping relay              |
| T             | ddd            | 0 to 255     | Bit: timer state                 |
| C             | ddd            | 0 to 255     | Bit: counter state               |
| D             | dddd           | 0 to 8999    | Word: data register              |
| SD            | dddd           | 9000 to 9255 | Word: special data register      |
| TV            | ddd            | 0 to 255     | Word: current value of the timer |

---

|      |     |            |                                       |
|------|-----|------------|---------------------------------------|
| CV   | ddd | 0 to 199   | Word: current value of the counter    |
| CV32 | ddd | 200 to 255 | Word: current value of 32-bit counter |

---

Note:

d represents decimal system, input scope is 0-9;

o represents octal system, input scope is 0-7;

Word in the remarks: represents the register can only be used as word;

Double-word in the remarks: represents that the data type of the register in configuration must be 32-bit;

Bit in the remarks: represents the register can only be used as bit;

Read only in the remarks represents that the register can only be read but not be written;

The names of the registers supported by different equipment model may be different, and the scopes may also be different;

For detailed name and scope, please consult related technical document of the connected device.

---

## 12.29 Xinje device driver

---

The device driver is used for SK HMI to read and write the data or state of Thinget XC/XCM/XD series PLC register. The serial communication connection is established through the serial port on the touch screen and the serial port of Thinget XC/XCM/XD series PLC, so as to operate Thinget XC/XCM/XD series PLC. Prior to use of the driver, one shall carefully read related technical specifications of the chapter and Thinget XC/XCM/XD series PLC.

How to establish connection with Thinget XC/XCM/XD series PLC

## 1. Hardware connection

Connecting cable:

RS232

| HMI series touch screen COM1/COM2 |     | Thinget XC/XCM/XD series |     |
|-----------------------------------|-----|--------------------------|-----|
| 2                                 | RX  | 5                        | TX  |
| 3                                 | TX  | 4                        | RX  |
| 5                                 | GND | 8                        | GND |

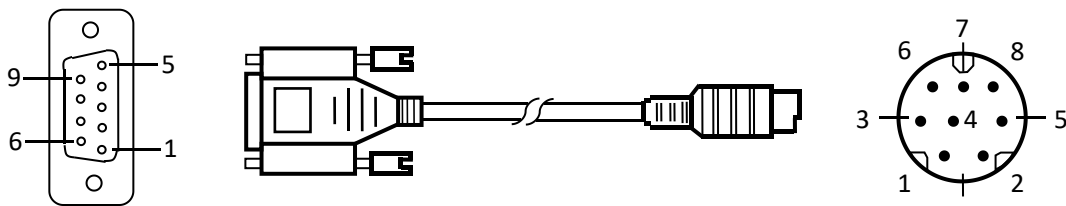

Terminal of HMI is DB9F, and that of Thinget XC/XCM/XD series PLC is MD8M.

## 2. Software settings

Select Xinje Electronic in connection device service.

Select the corresponding item in connection device service according to the connected PLC model or supported protocol.

Guarantee that communication parameters in touch screen connection parameters and PLC station number are consistent with the connected PLC.

For settings of the connected PLC, please consult related technical documents of Thinget XC/XCM/XD series PLC.

Default connection parameters of SK HMI

| Setting item            | Default parameter value | Setting scope                                |
|-------------------------|-------------------------|--|
| PLC type                | Thinget XC Series       | Thinget XC/XCM/XD Series                     |
| Communication port type | RS232                   | RS232/RS422/RS485                            |
| Baud rate               | 19200                   | 1200/2400/4800/9600/19200/38400/57600/115200 |
| Data bit length         | 8                       | 7/8  |
| Parity                  | EVEN                    | EVEN/ODD/NONE                                |
| Stop bit length         | 1                       | 1/2  |
| PLC station             | 1                       | 0 to 255                                     |

|                    |   |          |
|--------------------|---|----------|
| number             |   |          |
| HMI station number | 0 | 0 to 255 |

| Supporting function | Whether it is supported |
|---------------------|-------------------------|
| Offline simulation  | Yes                     |
| Online simulation   | Yes                     |
| Extended mode       | Yes                     |

### 3. Operational register and address scope

Thinget XC/XCM Series

| Register name | Address format | Input scope | Remarks                            |
|---------------|----------------|-------------|------------------------------------|
| X             | dddd           | 0 to 1037   | Bit: input coil                    |
| Y             | dddd           | 0 to 1037   | Bit: output coil                   |
| M             | dddd           | 0 to 8767   | Bit: internal coil                 |
| S             | dddd           | 0 to 1023   | Bit: process                       |
| T             | ddd            | 0 to 639    | Bit: timer state                   |
| C             | ddd            | 0 to 639    | Bit: counter state                 |
| D             | dddd           | 0 to 9023   | Word: data register                |
| TD            | ddd            | 0 to 639    | Word: current value of the timer   |
| CD            | ddd            | 0 to 639    | Word: current value of the counter |
| FD            | dddd           | 0 to 9023   | Word: FlashROM register            |
| ED            | dddd           | 0 to 16383  | Word: extended internal register   |

Thinget XD2 Series

| Register name | Address format | Input scope | Remarks                    |
|---------------|----------------|-------------|----------------------------|
| X             | o              | 0~7         | Input coil                 |
| Y             | o              | 0~7         | Output coil                |
| M             | dddd           | 0~7999      | Internal relay             |
| HM            | ddd            | 0~959       | Internal relay             |
| SM            | dddd           | 0~2047      | Special internal relay     |
| S             | dddd           | 0~1023      | Technological process      |
| HS            | ddd            | 0~127       | Technological process      |
| T             | ddd            | 0~575       | timer                      |
| TD            | ddd            | 0~575       | Timer current value        |
| HT            | dd             | 0~95        | timer                      |
| ET            | dd             | 0~31        | Precision timer            |
| ETD           | ddd            | 0~31        | Extended internal register |
| C             | ddd            | 0~575       | Counter                    |
| CD            | ddd            | 0~575       | Counter current value      |



|     |      |        |  |
|-----|------|--------|--|
| HC  | dd   | 0~95   | Counter  |
| HSC | dd   | 0~31   | High-speed counter                             |
| D   | dddd | 0~7999 | Data register                                  |
| HD  | ddd  | 0~999  | Data register                                  |
| SD  | dddd | 0~2047 | Special data register                          |
| HSD | ddd  | 0~499  | Special data register                          |
| FD  | dddd | 0~4095 | FlashROMregister                               |
| SFD | dddd | 0~1999 | FlashROMregister                               |
| FS  | dd   | 0~47   | Special security register                      |
| SEM | dd   | 0~31   | Sequential function block WAIT<br>Command coil |

### Thinget XD3 Series

| Register name | Address format | Input scope | Remarks   |
|---------------|----------------|-------------|---|
| X             | oooo           | 0~20077     | Input coil (X10000~X11177 belongs to extended module)<br>(X20000~X20277 belongs to extended BD module)              |
| Y             | oooo           | 0~20077     | The output coil (Y10000~Y11177 belongs to the extended module)<br>(Y20000~Y20277 belongs to the extended BD module) |
| M             | dddd           | 0~7999      | Internal relay  |
| HM            | ddd            | 0~959       | Internal relay  |
| SM            | dddd           | 0~2047      | Special internal relay  |
| S             | dddd           | 0~1023      | Technological process   |
| HS            | ddd            | 0~127       | Technological process   |
| T             | ddd            | 0~575       | timer   |
| TD            | ddd            | 0~575       | Timer current value   |
| HT            | dd             | 0~95        | timer   |
| ET            | dd             | 0~31        | Precision timer   |
| ETD           | ddd            | 0~31        | Extended internal register  |
| C             | ddd            | 0~575       | Counter   |
| CD            | ddd            | 0~575       | Counter current value   |
| HC            | dd             | 0~95        | Counter   |
| HSC           | dd             | 0~31        | High-speed counter  |
| D             | dddd           | 0~7999      | Data register   |
| HD            | ddd            | 0~999       | Data register   |
| SD            | dddd           | 0~2047      | Special data register   |
| HSD           | ddd            | 0~499       | Special data register   |
| FD            | dddd           | 0~4095      | FlashROM register   |
| SFD           | dddd           | 0~1999      | FlashROM register   |
| FS            | dd             | 0~47        | Special security register   |
| ID            | dddd           | 0~20099     | Ontology (ID10000~ID10999 is an extension module)<br>(ID20000~20099 belongs to the extended BD module)              |

|     |      |         |  |
|-----|------|---------|--|
| QD  | dddd | 0~20099 | Ontology (QD10000~QD10999 is an extension module)<br>(QD20000~QD20099 belongs to the extended BD module) |
| SEM | dd   | 0~31    | Sequential function block WAIT Command coil  |

#### Thinget XD5/XDM Series

| Register name | Address format | Input scope | Remarks   |
|---------------|----------------|-------------|---|
| X             | oooo           | 0~20077     | Input coil (X10000~X11177 belongs to extended module)<br>(X20000~X20277 belongs to extended BD module)              |
| Y             | oooo           | 0~20077     | The output coil (Y10000~Y11177 belongs to the extended module)<br>(Y20000~Y20277 belongs to the extended BD module) |
| M             | dddd           | 0~20479     | Internal relay  |
| HM            | dddd           | 0~11999     | Internal relay  |
| SM            | ddd            | 0~4095      | Special internal relay  |
| S             | ddd            | 0~7999      | Technological process   |
| HS            | ddd            | 0~999       | Technological process   |
| T             | ddd            | 0~4095      | timer   |
| TD            | ddd            | 0~575       | Timer current value   |
| HT            | ddd            | 0~1023      | timer   |
| ET            | dd             | 0~39        | Precision timer   |
| ETD           | ddd            | 0~39        | Extended internal register  |
| C             | ddd            | 0~4095      | Counter   |
| CD            | ddd            | 0~4095      | Counter current value   |
| HC            | ddd            | 0~1023      | Counter   |
| HSC           | dd             | 0~36        | High-speed counter  |
| D             | dddd           | 0~20479     | Data register   |
| HD            | dddd           | 0~6143      | Data register   |
| SD            | ddd            | 0~4095      | Special data register   |
| HSD           | ddd            | 0~1023      | Special data register   |
| FD            | ddd            | 0~4095      | FlashROM register   |
| SFD           | ddd            | 0~5999      | FlashROM register   |
| FS            | dd             | 0~47        | Special security register   |
| ID            | dddd           | 0~20099     | Ontology (ID10000~ID10999 is an extension module)<br>(ID20000~20099 belongs to the extended BD module)              |
| QD            | dddd           | 0~20099     | Ontology (QD10000~QD10999 is an extension module)<br>(QD20000~QD20099 belongs to the extended BD module)            |
| SEM           | ddd            | 0~127       | Sequential function block WAIT Command coil   |

Note:

d represents decimal system, input scope is 0-9;

---

o represents octal input range 0-7;

Word in the remarks: represents the register can only be used as word;

Bit in the remarks: represents the register can only be used as bit;

Read only in the remarks represents that the register can only be read but not be written;

The names of the registers supported by different equipment model may be different, and the scopes may also be different.

For detailed name and scope, please consult related technical document of the connected device

---

## 12.30 Yokogawa device driver

---

The device driver is used for SK HMI to read and write the data or state of Yokogawa FA-M3 series PLC register. The serial communication connection is established through the serial port on the touch screen and the serial port of Yokogawa FA-M3 series PLC, so as to operate Yokogawa FA-M3 series PLC. Prior to use of the driver, one shall carefully read related technical specifications of the chapter and Yokogawa FA-M3 series PLC.

How to establishment connection with Yokogawa FA-M3 series PLC

### 1. Hardware connection

Connecting cable:  
RS232

| SK HMI COM1/COM2 |     | Yokogawa FA-M3 series |     |  |
|------------------|-----|-----------------------|-----|--|
| 5                | GND | 5                     | SG  | 4-5 short-circuited<br>220Ω resistor in series |
| 6                | RX- | 4                     | SDB |  |
| 7                | RX+ | 3                     | SDA | 2-3 short-circuited<br>220Ω resistor in series |
| 8                | TX- | 2                     | RDB |  |
| 9                | TX+ | 1                     | RDA |  |
|                  |     | 6                     | CSA | 6-7 short-circuited                            |
|                  |     | 7                     | ERA |  |
|                  |     | 8                     | CSB | 8-9 short-circuited                            |
|                  |     | 9                     | ERB |  |

Terminal of HMI is DB9F, and that of Yokogawa FA-M3 series PLC is SIO.

## 2. Software settings

Select Yokogawa Electric Corp. in connection device service.

Select the corresponding item in connection device service according to the connected PLC model or supported protocol.

Guarantee that communication parameters in touch screen connection parameters and PLC station number are consistent with the connected PLC.

For settings of the connected PLC, please consult related technical documents of Yokogawa FA-M3 series PLC.

### Default connection parameters of SK HMI

| Setting item            | Default parameter value | Setting scope                                |
|-------------------------|-------------------------|--|
| PLC type                | Yokogawa FA-M3          | Yokogawa FA-M3                               |
| Communication port type | RS422                   | RS232/RS422/RS485                            |
| Baud rate               | 9600                    | 1200/2400/4800/9600/19200/38400/57600/115200 |
| Data bit length         | 8                       | 7/8  |
| Parity                  | EVEN                    | EVEN/ODD/NONE                                |
| Stop bit length         | 1                       | 1/2  |
| PLC station number      | 1                       | 0 to 255                                     |
| HMI station number      | 0                       | 0 to 255                                     |

| Supporting function | Whether it is supported |
|---------------------|-------------------------|
| Offline simulation  | Yes                     |
| Online simulation   | Yes                     |
| Extended mode       | No                      |

## 3. Operational register and address scope

| Register name | Address format | Input scope | Remarks   |
|---------------|----------------|-------------|---|
| X             | dddd           | 0 to 71664  | Bit: input, discontinuous, determined by the slot number  |
| Y             | dddd           | 0 to 71664  | Bit: output, discontinuous, determined by the slot number |

|   |      |            |                                       |
|---|------|------------|---------------------------------------|
| M | dddd | 0 to 16384 | Bit: special relay                    |
| I | dddd | 0 to 71024 | Bit: internal relay                   |
| L | dddd | 0 to 9984  | Bit: link relay, discontinuous        |
| D | dddd | 0 to 8192  | Word: data register                   |
| B | dddd | 0 to 32768 | Word: file register                   |
| V | dddd | 0 to 64    | Word: external switching value output |
| W | dddd | 0 to 71024 | Word: link register, discontinuous    |
| Z | dddd | 0 to 512   | Word: special register                |

Note:

d represents decimal system, input scope is 0-9;

Word in the remarks: represents the register can only be used as word;

Bit in the remarks: represents the register can only be used as bit;

Read only in the remarks represents that the register can only be read but not be written;

The names of the registers supported by different equipment model may be different, and the scopes may also be different.

For detailed name and scope, please consult related technical document of the connected device

## 12.31 ZhengHang device driver

The device driver is used for SK HMI to read and write the data or state of ZhengHang A5 series PLC register. The serial communication connection is established through the serial port on the touch screen and the serial port of Yokogawa FA-M3 series PLC, so as to operate ZhengHang A5series PLC. Prior to use of the driver, one shall carefully read related technical specifications of the chapter and ZhengHang A5 series PLC.

How to establishment connection with ZhengHang A5 series PLC

### 4. Hardware connection

Connecting cable:

RS232

| SK | HMI | COM1/COM2 | ZhengHang A5 |     |
|----|-----|-----------|--------------|-----|
| 2  |     | RX        | 2            | TX  |
| 3  |     | TX        | 3            | RX  |
| 5  |     | GND       | 5            | GND |

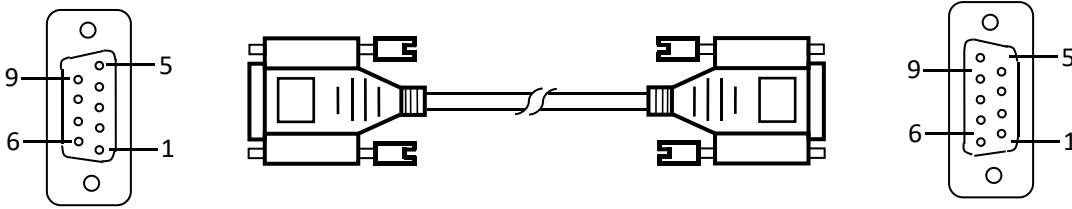

Terminal of HMI is DB9F, and that of ZhengHang A5 series PLC is DB9M.

## 5. Software settings

Select ZhengHang Electronics in connection device service.

Select the corresponding item in connection device service according to the connected PLC model or supported protocol.

Guarantee that communication parameters in touch screen connection parameters and PLC station number are consistent with the connected PLC.

For settings of the connected PLC, please consult related technical documents of ZhengHang A5 series PLC.

Default connection parameters of SK HMI

| Setting item            | Default parameter value | Setting scope     |
|-------------------------|-------------------------|-------------------|
| PLC type                | A5 Series               | A5 Series         |
| Communication port type | RS232                   | RS232/RS422/RS485 |

|                    |      |  |
|--------------------|------|--|
| Baud rate          | 9600 | 1200/2400/4800/9600/19200/38400/57600/115200 |
| Data bit length    | 8    | 7/8  |
| Parity             | NONE | EVEN/ODD/NONE                                |
| Stop bit length    | 1    | 1/2  |
| PLC station number | 1    | 0~255  |
| HMI station number | 0    | 0~255  |

| Supporting function | Whether it is supported |
|---------------------|-------------------------|
| Offline simulation  | Yes                     |
| Online simulation   | Yes                     |
| Extended mode       | Yes                     |

## 6. Operational register and address scope

| Register name | Address format | Input scope   | Remarks   |
|---------------|----------------|---------------|---|
| I             | dd.o           | 0.0 to 15.7   | Bit: input image register, read only                                      |
| Q             | dd.o           | 0.0 to 15.7   | Bit: output image register  |
| M             | dddd.o         | 0.0 to 4095.7 | Bit: bit memory   |
| VW            | dddd           | 0 to 1998     | Word: variable memory, 8-digit register, each word occupies two addresses |
| AIW           | d              | 0 to 9        | Word: analog input, read only   |
| AQW           | d              | 0 to 9        | Word: analog output, write only   |

Note:

d represents decimal system, input scope is 0-9;

---

o represents octal system, input scope is 0-7;

Word in the remarks: represents the register can only be used as word;

Bit in the remarks: represents the register can only be used as bit;

Read only in the remarks represents that the register can only be read but not be written;

The names of the registers supported by different equipment model may be different, and the scopes may also be different.

For detailed name and scope, please consult related technical document of the connected device

---



### 13. Number signals of communication errors between HMI and PLC

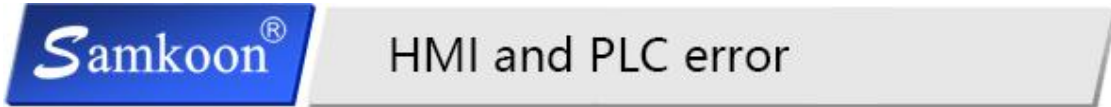

| Error Code | Information                                  | Error Code | Information  |
|------------|--|------------|--|
| 0x11       | Local data-Real-time read-ECC Error          | 0x41       | Local data-Real-time read-No data returned           |
| 0x12       | Local data-Write operation-ECC Error         | 0x42       | Local data-Write operation- No data returned         |
| 0x13       | Local data-Read historical data-ECC Error    | 0x43       | Local data-Read historical data- No data returned    |
| 0x14       | Local data-Read alarm-ECC Error              | 0x44       | Local data-Read alarm- No data returned              |
| 0x15       | Local data-Read formula-ECC Error            | 0x45       | Local data-Read formula- No data returned            |
| 0x16       | Local data-Write formula-ECC Error           | 0x46       | Local data-Write formula- No data returned           |
| 0x17       | Local data-Read data transmission-ECC Error  | 0x47       | Local data-Read data transmission-No data returned   |
| 0x18       | Local data-Write data transmission-ECC Error | 0x48       | Local data-Write data transmission- No data returned |
| 0x19       | Local data-Read clock-ECC Error              | 0x49       | Local data-Read clock- No data returned              |
| 0x20       | Local data-Write clock-ECC Error             | 0x50       | Local data-Write clock- No data returned             |
| 0x21       | Local data-Read macro-ECC Error              | 0x51       | Local data-Read macro- No data returned              |
| 0x22       | Local data-Write macro-ECC Error             | 0x52       | Local data-Write macro- No data returned             |

|              |   |              |  |
|--------------|---|--------------|--|
|              |   |              | returned   |
| <b>0x71</b>  | Local data-Real-time read-Wrong return length           | <b>0x111</b> | Penetrating data-Real-time read-ECC Error                  |
| <b>0x72</b>  | Local data-Write operation-Wrong return length          | <b>0x112</b> | Penetrating data -Write operation-ECC Error                |
| <b>0x73</b>  | Local data-Read historical data-Wrong return length     | <b>0x113</b> | Penetrating data-Read historical data-ECC Error            |
| <b>0x74</b>  | Local data-Read alarm- Wrong return length              | <b>0x114</b> | Penetrating data-Read alarm-ECC Error                      |
| <b>0x75</b>  | Local data-Read formula- Wrong return length            | <b>0x115</b> | Penetrating data-Read formula-ECC Error                    |
| <b>0x76</b>  | Local data-Write formula- Wrong return length           | <b>0x116</b> | Penetrating data-Write formula-ECC Error                   |
| <b>0x77</b>  | Local data-Read data transmission- Wrong return length  | <b>0x117</b> | Penetrating data-Read data transmission-ECC Error          |
| <b>0x78</b>  | Local data-Write data transmission- Wrong return length | <b>0x118</b> | Penetrating data-Write data transmission-ECC Error         |
| <b>0x79</b>  | Local data-Read clock- Wrong return length              | <b>0x119</b> | Penetrating data-Read clock-ECC Error                      |
| <b>0x80</b>  | Local data-Write clock- Wrong return length             | <b>0x120</b> | Penetrating data-Write clock-ECC Error                     |
| <b>0x81</b>  | Local data-Read macro- Wrong return length              | <b>0x121</b> | Penetrating data-Read macro-ECC Error                      |
| <b>0x82</b>  | Local data-Write macro- Wrong return length             | <b>0x122</b> | Penetrating data-Write macro-ECC Error                     |
| <b>0x141</b> | Penetrating data-Real-time read-No data returned        | <b>0x171</b> | Penetrating data-Real-time read-Wrong return length        |
| <b>0x142</b> | Penetrating data-Write operation- No data returned      | <b>0x172</b> | Penetrating data-Write operation-Wrong return length       |
| <b>0x143</b> | Penetrating data-Read historical data- No data returned | <b>0x173</b> | Penetrating data-Read historical data- Wrong return length |

|              |  |              |   |
|--------------|--|--------------|---|
| <b>0x144</b> | Penetrating data-Read alarm- No data returned              | <b>0x174</b> | Penetrating data-Read alarm- Wrong return length              |
| <b>0x145</b> | Penetrating data-Read formula- No data returned            | <b>0x175</b> | Penetrating data-Read formula- Wrong return length            |
| <b>0x146</b> | Penetrating data-Write formula- No data returned           | <b>0x176</b> | Penetrating data-Write formula- Wrong return length           |
| <b>0x147</b> | Penetrating data-Read data transmission-No data returned   | <b>0x177</b> | Penetrating data-Read data transmission- Wrong return length  |
| <b>0x148</b> | Penetrating data-Write data transmission- No data returned | <b>0x178</b> | Penetrating data-Write data transmission- Wrong return length |
| <b>0x149</b> | Penetrating data-Read clock- No data returned              | <b>0x179</b> | Penetrating data-Read clock- Wrong return length              |
| <b>0x150</b> | Penetrating data-Write clock- No data returned             | <b>0x180</b> | Penetrating data-Write clock- Wrong return length             |
| <b>0x151</b> | Penetrating data-Read macro- No data returned              | <b>0x181</b> | Penetrating data-Read macro- Wrong return length              |
| <b>0x152</b> | Penetrating data-Write macro- No data returned             | <b>0x182</b> | Penetrating data-Write macro- Wrong return length             |
| <b>0x201</b> | Handshake failure  |              |   |

---

## 14. Appendix



- [Export data via U disk](#)
- [Picture format](#)
- [Import project via U disk](#)
- [Import formula via U disk](#)
- [Dial switch](#)

### 14.1 Export data via U disk

---

SK series HMI supports exporting historical data, recipes, historical alarms and screenshots via U disk.

Group number is necessary to export historical data resulting from the added function of multiple groups of historical data in the SKTOOL. LW60408 is the group number of the selected history data. For example: Set LW60408 to 1, which means the current historical data for import and export via U disk is aimed at historical data Group 0, instead of others.

Note: If the numerical input value exceeds the maximum group minus 1, this function does not work.

#### **How to export historical data via U disk**

1. Insert the USB disk
2. Set the group number of history data for import and export in the LW60480 register.
3. Trigger LB60127 to ON and then HMI will copy the history data group file to USB disk, named hisdatai.csv; hisdata1.csv if the group number is 1.

Trigger LB60128 to ON and then HMI will copy the history data group file to USB disk; if you want to import the Group 1, name the file hisdata1.csv.

These triggers are automatically reset to OFF when the export is complete

When exporting local data, employ the LW register: LW60359-LW60429

---

### How to export formula

It needs to set LW61143 for formula export operation result from multiple groups of formula in the SKTOOL.

1. Insert the USB stick.
2. Set the group number in LW61143.
3. Trigger LB60163 to ON; HMI will copy the group formula file to U disk
4. These triggers are automatically reset to OFF when the export is complete

Note: It cannot open directly the historical data exported to the computer, so it needs a data

conversion tool, SK\_SQL\_CSV.exe,  which is under the root directory of SK configuration software.

Use this tool to convert the exported file into a CSV file that can be opened directly. Double-click to open the tool.



Progress: The progress of the file conversion.

File name: Select the file to convert.

Select historical data or alarm accordingly. The default encoding is ANSI that cannot be modified. After settings, click "Generate CSV". When the progress bar reaches 100%, the conversion is complete.

---

### How to get screenshots via U disk

1. Insert the USB disk
2. When configuring, create a Function button -> Screenshot, and select Export to U disk
3. Touch this function button and then HMI will capture the current screen to the corresponding memory

---

#### Note:

- Do not disconnect the USB disk during the export operation;
  - Maintain the power ON during the export operation;
  - Make sure that your USB disk has enough storage space.
- 

## 14.2 Picture Format

---

SK series HMI is compatible with a variety of image formats, such as JPG, BMP, GIF, PNG and so on. However, in order to ensure the display efficiency, the picture format is compressed by default, and also converted into the JPG format (except GIF display control).

If you want to retain the original format, select HMI parameter settings -> printer downloading settings, and then set the picture option to keep the original format.

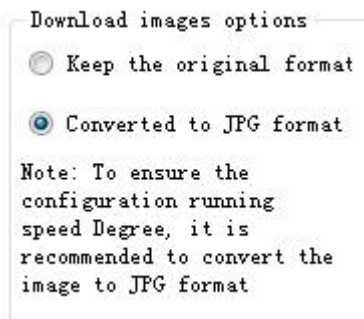

---

#### Note:

- Conversion to JPG format is meant to ensure more pictures to be used;

- Employ of pictures whose resolution does not exceed that of the touch screen can improve the display efficiency;
- The maximum number of frames for a GIF image is 32.

### 14.3 Update project via U disk

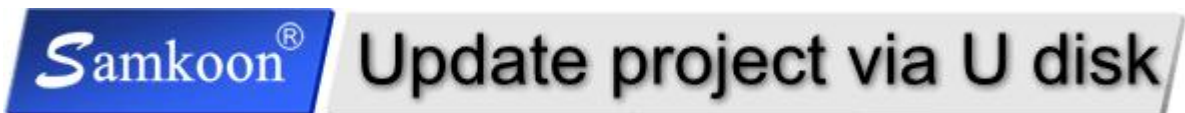

SK Series HMI supports importing and updating project via U disk.

#### How to update the project file via U disk

##### 1. Compile the project

Run SKTOOL; open the project you want to update; click  to generate the compiled file.

Select Extract U disk file, Select the corresponding version of the usb file, Select save directory. As shown below

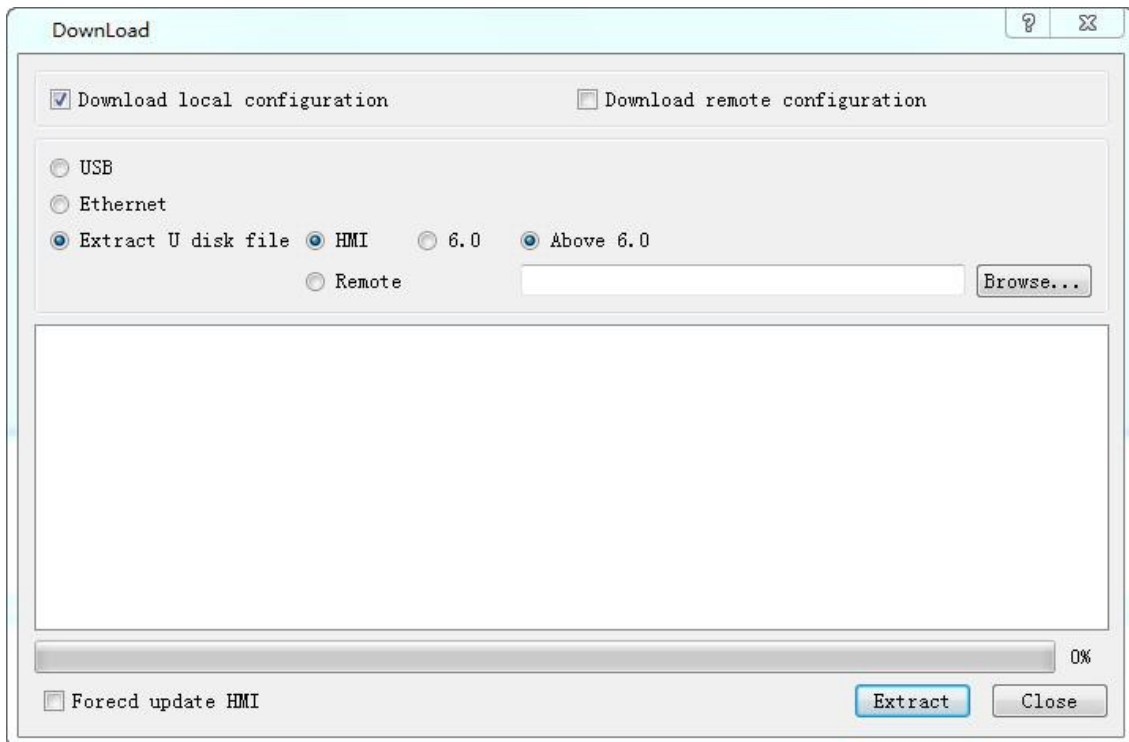

##### 2. Click "Save Project As" in "Download", then select the save directory

The file u-disk-prj.bin will be stored in the selected directory.

---

### 3. Copy the compiled file to the USB disk

Open the directory, copy u-disk-prj.bin to the U disk.

### 4. Insert the U disk to HMI

### 5. Copy the file and re-update the project

After inserting U disk into HMI, click YES in the pop-up window to execute the update operation.



### 6. Restart HMI to complete updating

Restart the power supply or restart the HMI by clicking the "Restart" button on the screen.

---

#### Note

- Do not disconnect the USB flash drive during the update process;
- Maintain HMI ON during the update process.

---

## 14.4 Update recipe via U disk

SK Series HMI supports importing and updating recipe via U disk.

### How to update the recipe file via U disk

#### 1. Compile the project

Run SKTOOL; open the project you want to update; click



to generate the

compiled file.

#### 2. Copy the compiled file to the USB disk

Open the directory, copy u-disk-prj.bin to the U disk.



---

### 3. Rename the recipe.bin

Rename the recipe.bin as u-disk-recipe.bin

### 4. Insert the U disk to HMI

### 5. Copy the file and re-update the project

After inserting U disk into HMI, click YES in the pop-up window to execute the update operation.



### 6. Restart HMI to complete updating

Restart the power supply or restart the HMI by clicking the "Restart" button on the screen.

---

#### Note

- Do not disconnect the USB flash drive during the update process;
  - Maintain HMI ON during the update process.
- 

## 14.5 Dial switch

---

Each SK series HMI has dial switch, each of which has its functions.

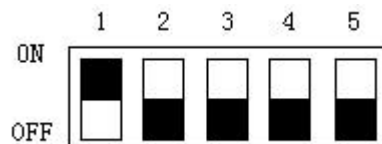

#### Function list of dial switch

| Dial switch (5-1) | Function                    |
|-------------------|-----------------------------|
| All off           | Normal Operation Mode       |
| On 1              | Coordinate Calibration Mode |
| On 2              | Parameter Display Mode      |

---

|              |                        |
|--------------|------------------------|
| On 3         | Terminal Mode          |
| On 1 and On3 | Parameter Setting Mode |

---

**Note:**

It needs to restart HMI after adjusting dial switch;

Please apply Normal Operation Mode when using HMI normally;

Parameter Settings Mode applies to set the time, luminance and IP address.

---

---

## 15. Operation case (Supplement)



---

This chapter introduces mainly several cases of SKTOOL configuration software meant for SK series HMI, for your reference.

### Contents:

- [QuickStart: A Simple Macroblock](#)
- [Free Port Communication Protocol Case](#)
- [Historical Data Collector Case](#)
- [Recipe Case](#)
- [Digital Alarm Login](#)
- [Analog Alarm Login](#)
- [Usb update PLC program](#)

### 15.1 A simple macroblock



Create a new project; select the appropriate HMI model. The script module will implement the following simple arithmetic functions: Initialize the "Numerical display" control with the array char source [4] = {2, 3, 4, 5} element value through the Init script; read the input data from the external through the numerical display control; and then the execution of the ADDSUM script will be triggered by pressing the "=" button and the result of its execution will be displayed via this control.

---

Detailed steps are as follows:

**Step 1: <Create a new script>**

Click the shortcut function button "script editor" on the left side of the toolbar, and then it will pop up a dialog box .

**Step 2: <Create the macro Init>**

Click the  button in the script editor interface, it will appear a new script on "Not Save"list, as shown in Figure 5-7; Modify the script name in Script edit control, and edit the source code on the Script Edit Window,as shown in Figure 5-8

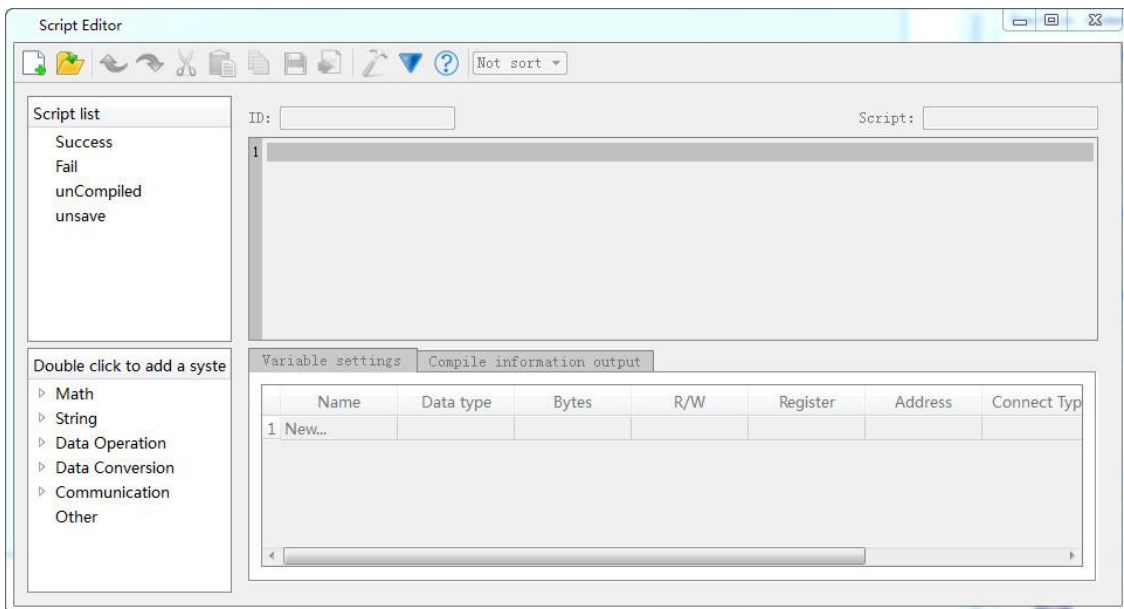

Figure 5-7 new a script

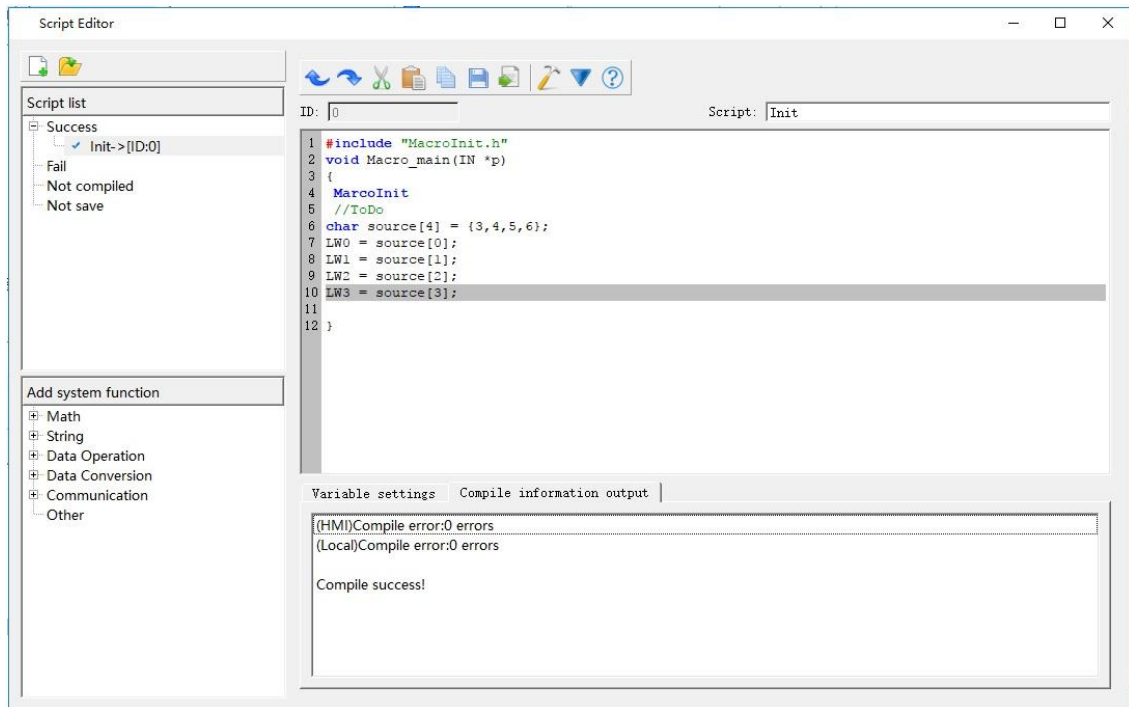

Figure 5-8 Edit Init Script



Macro names can only consist of Arabic numerals (0-9), English characters (a-z, A-Z), and underline (\_). Enter the following contents as shown in Figure 5-9:

### Step 3: <Variable settings>

Record the attribute settings such as variable name, variable type, etc, in the window as shown in Figure 5-9. Double click in the "Variable Setting" window, or right click to pop up the shortcut menu, and then select "New Variable" item to pop up a dialog box as shown in Figure 5-10 where to set values of the external variables.

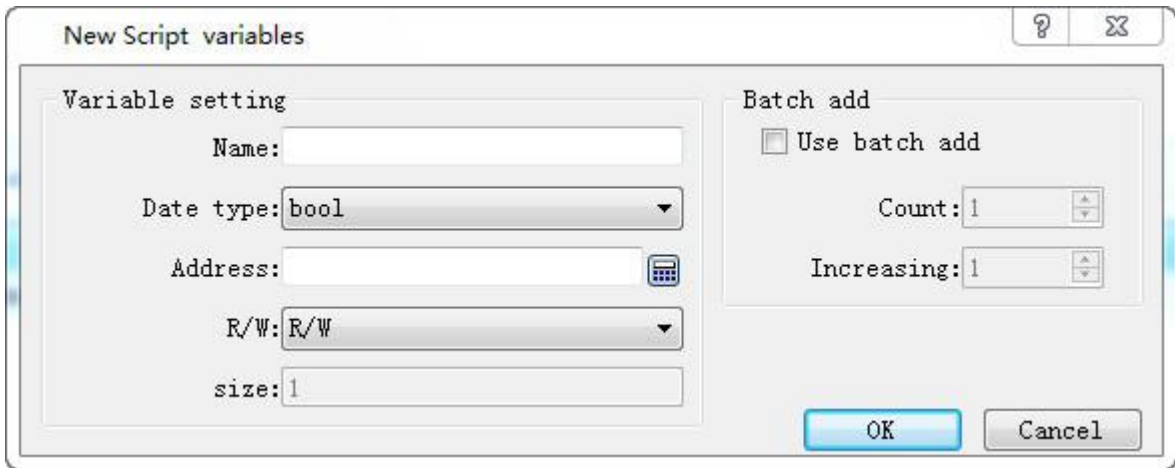

Figure5-9 Script Code Tag

Name: Input LW0, LW1, LW2, LW3 respectively in variable name;

Data Type: Set the 16-bit integer;

Read / write: Select to read and write (read and write);

The address settings are: LW0 = 0, LW1 = 1, LW2 = 2, LW3 = 3;

After the settings, the results are shown in Figure 5-10.

| Name     | Data type       | Bytes | R/W | Register | Address | Connect Type     | Station |
|----------|-----------------|-------|-----|----------|---------|------------------|---------|
| 1 LW0    | 16-Bit Unsig... | 2     | R/W | LW       | 0       | Internal stor... | 100     |
| 2 LW1    | 16-Bit Unsig... | 2     | R/W | LW       | 1       | Internal stor... | 100     |
| 3 LW2    | 16-Bit Unsig... | 2     | R/W | LW       | 2       | Internal stor... | 100     |
| 4 LW3    | 16-Bit Unsig... | 2     | R/W | LW       | 3       | Internal stor... | 100     |
| 5 New... |                 |       |     |          |         |                  |         |

Figure5-10 Variable Setting

**Step 4: <Compile the source file>**

After completing the above steps, the next is to compile; click the compile button as shown in Figure 5-11, it will save, compile, connect and check other errors automatically.

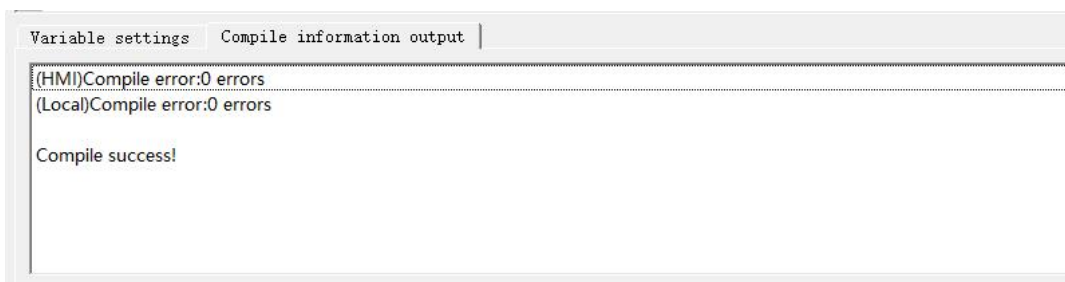

Figure 5-11 Information Output

When the message output window displays "0 errors! Compile successfully", it indicates that this macro has been successfully created and will be automatically added to the compiled list box; otherwise, an error message will be displayed while the macro will be added automatically to the unsuccessful compilation list. Users can modify, edit the macro until the successful completion of the compilation.

**Step 5: <Create the script ADDSUM>**

Follow steps 2 - 4 to create the script ADDSUM, as shown in Figure 5-13

<1>: Enter "ADDSUM" in the script name.

<2>: Enter the contents of the circle in the code-editing window.

<3>: Set the corresponding variable attribute value in the variable setting window.

<4>: Click the Compile button.

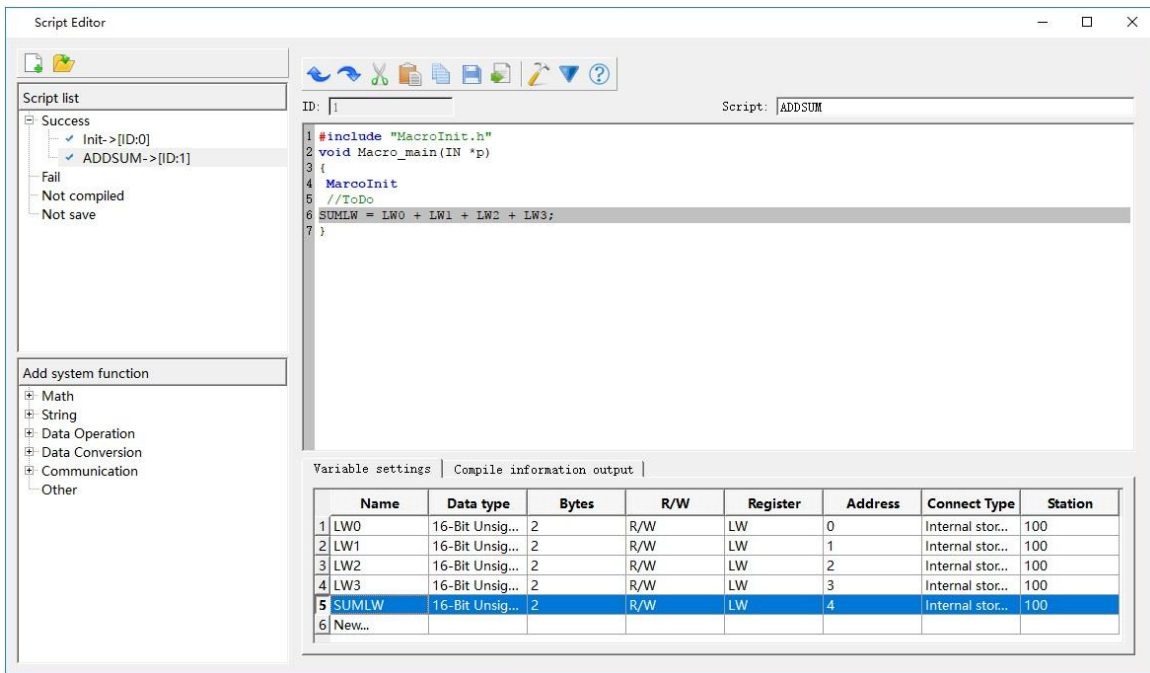

Figure 5-13 Creating the script ADDSUM

**Step 6: <Edit Control>**

<1>. Place controls on the project screen and adjust them to the appropriate size, as shown in Figure 5-14.

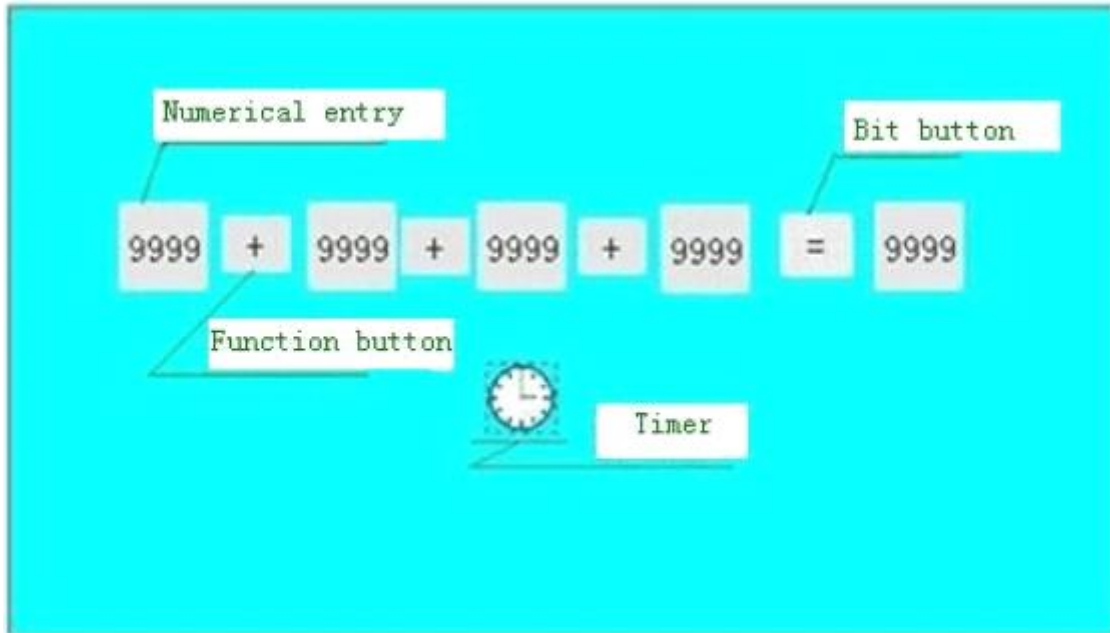

Figure 5-14 Control Layout

<2>. Set the corresponding control attribute parameters

Right click on the "Numeric Input" control and set the address value and attribute of each control, as shown in Figure 5-15.

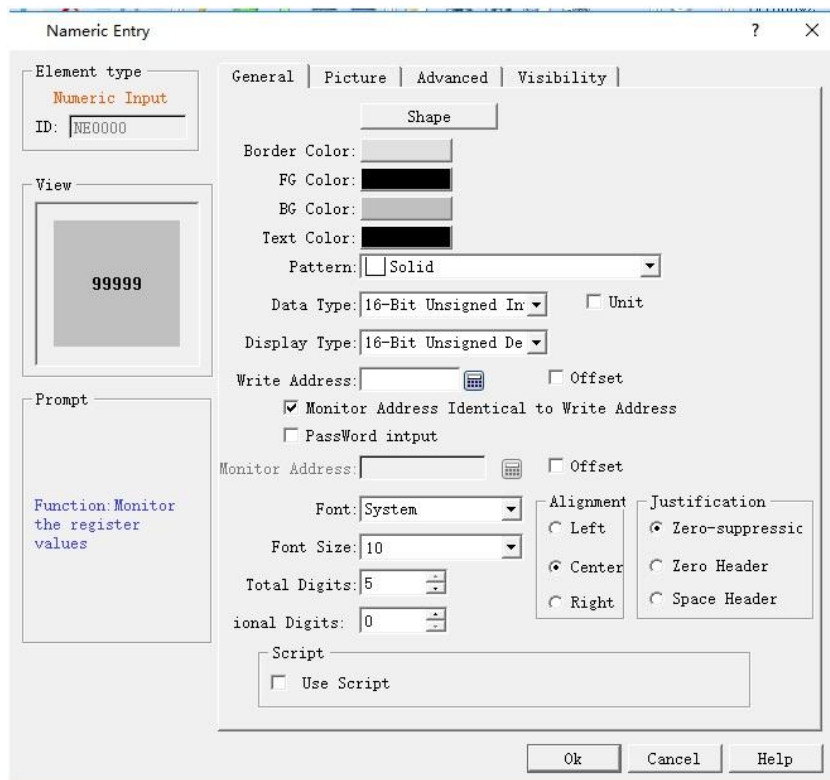

Figure 5-15 numeric input property setting



---

It is essential to ensure that the LW0, LW1, LW2, LW3, SumLW variable addresses correspond to the "write address" (shown in Figure 5-15) of each control. Click "OK" button to save the settings.

<3>. Set properties of Bit button control

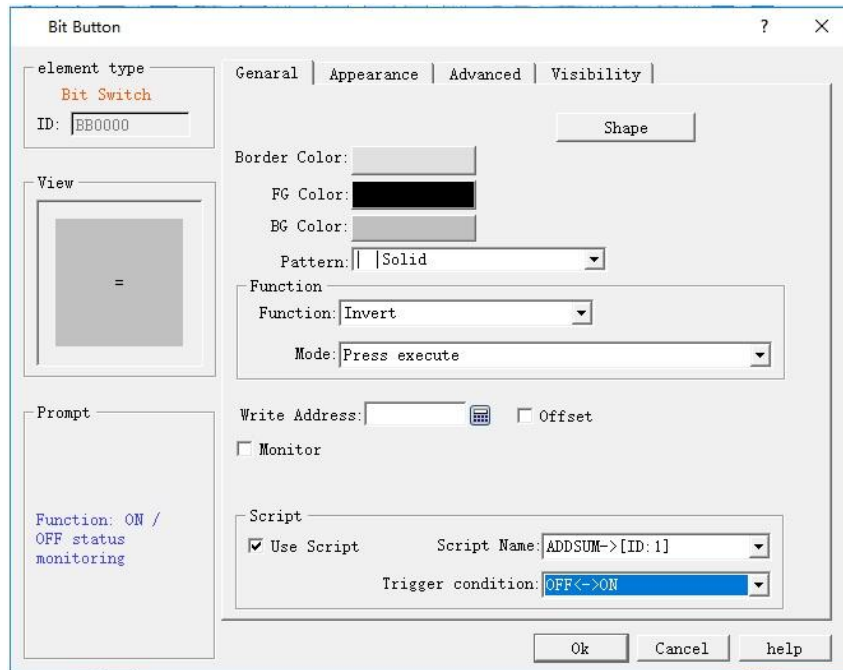

Figure 5-16 (Bit Button Property Setting)

<4>. Property setting of Timer

Select the script Init; click "OK" to save the settings.

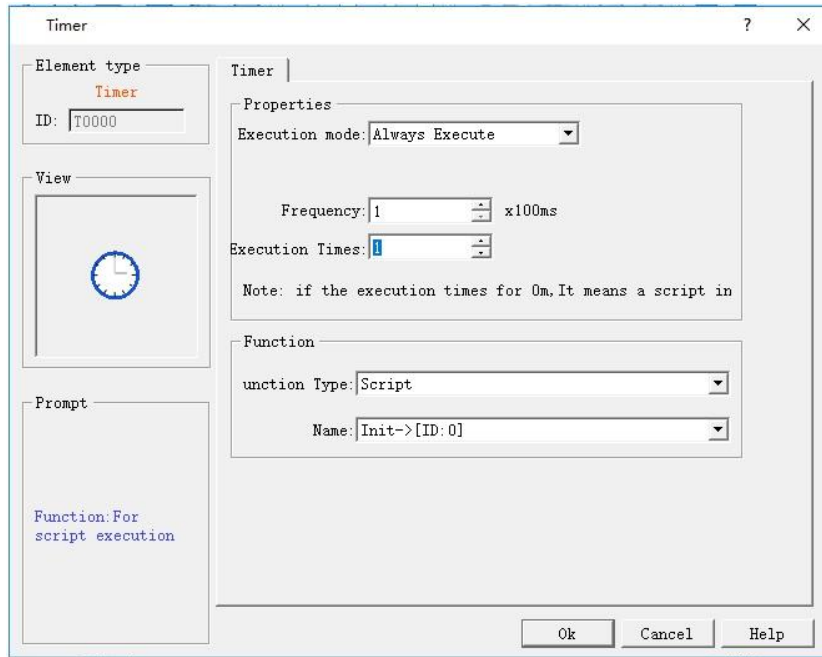

Figure 5-17 Timer Property Setting

<5>. Select the "Label" -> "Text" page of the Function button, and enter the "+" character in the text box, as shown in Figure 5-18.

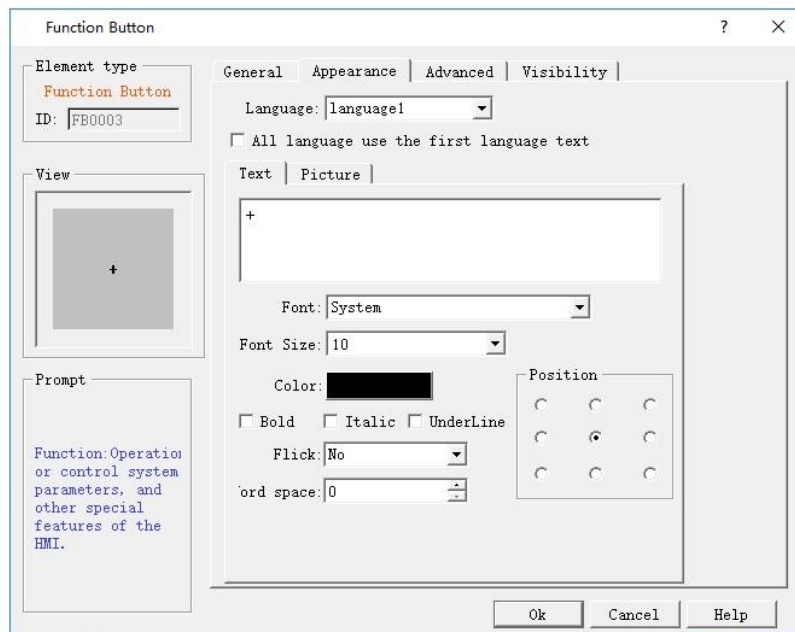

Figure 5-18 Function Button Property Setting

### Step 7: Compile and download to HMI

---

<1>: Click the compile icon to execute the operation.



Figure 5-19 General Project Compile

<2>: Select "Download (D) -> USB download (D)", then click "Download" in the pop-up dialog box.

Restart the HMI.

You can also click the shortcut function button Compile Download.

**Step 8: <Result Test>**

After restarting the HMI, the following screen appears (Figure 5-20).

This is because at startup, the first instruction, Init, is the first to be executed by the timer.

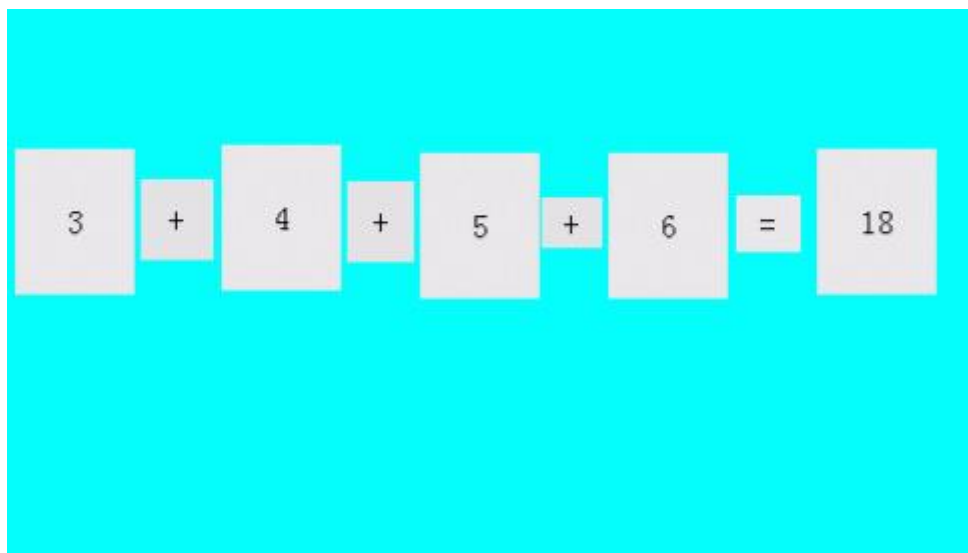

Figure 5-20 showing the initial value

---

Input data such as "31,42,53,64" respectively in the "Numeric display" control, click on the "=" button to implement the ADDSUM script and the output result will be 190, as shown in Figure 5-21:

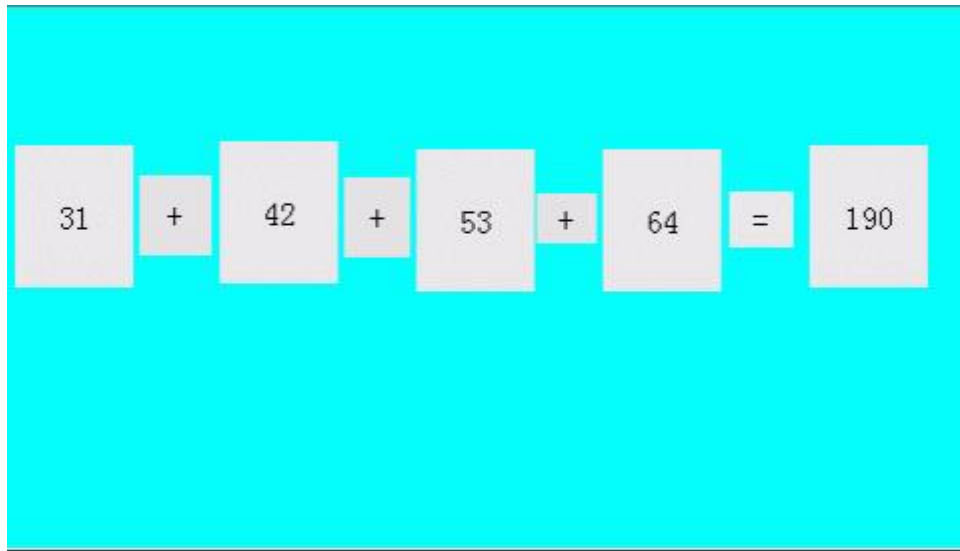

Figure5-21 result display

So far it has completed successfully the script editing, compiling, downloading, testing and all the necessary functions.

## 15.2 Free Port Communication Protocol Case



First, create three configurations:



Configuration 1

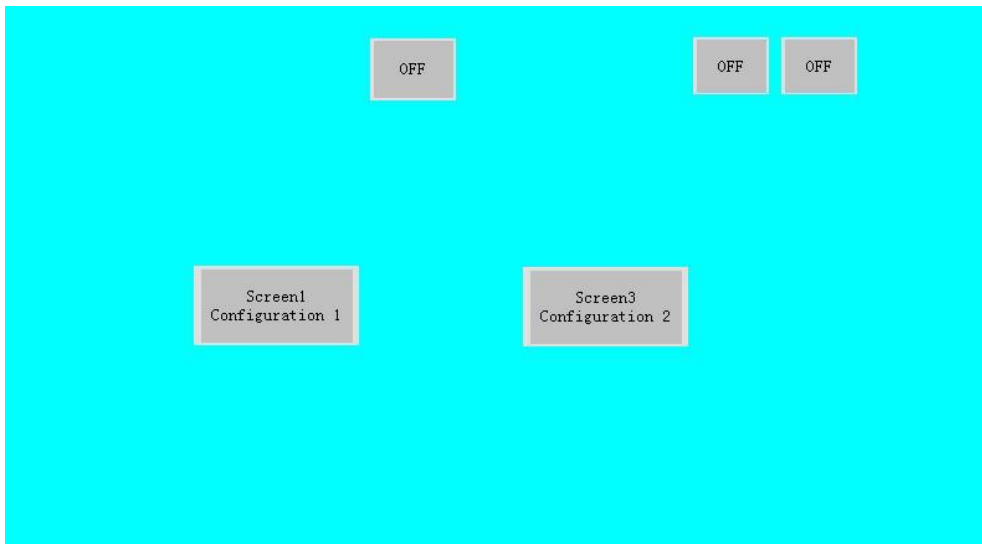

Configuration 2

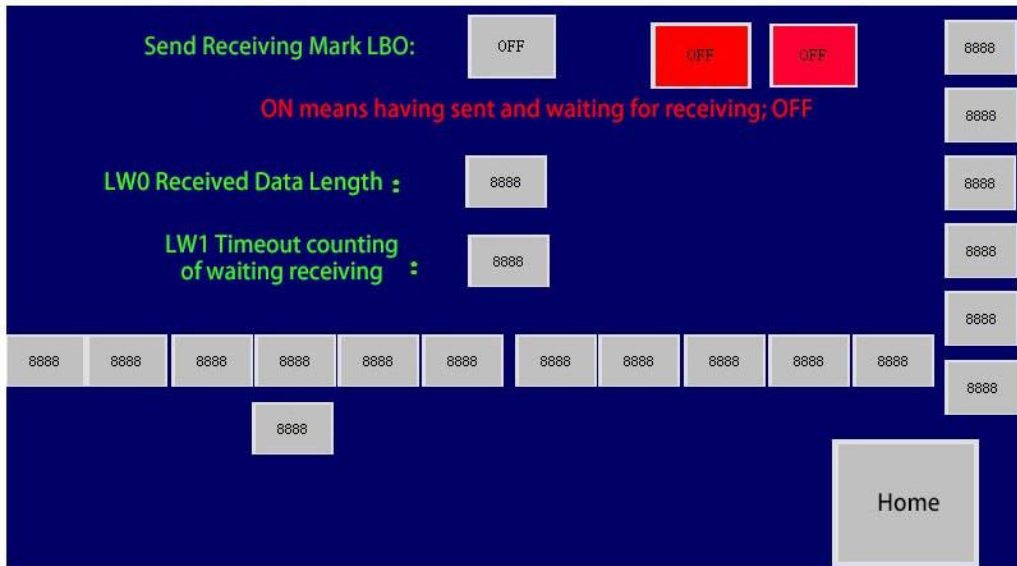

Configuration 3

The six controls on the right side of Configuration 1 and 3 are numeric display controls whose monitoring addresses are respectively LW60297, LW60298, LW60299, LW60300, LW60301 and LW60302 = 1, from top to bottom. Two red controls are that of bit indicator light whose monitoring addresses are LB100 and LB101, respectively. Controls below Configuration 3 are numeric display controls, starting at address LW400 with an address interval of 1.

The "Advanced" settings for the two screen buttons in Configuration 2 are:

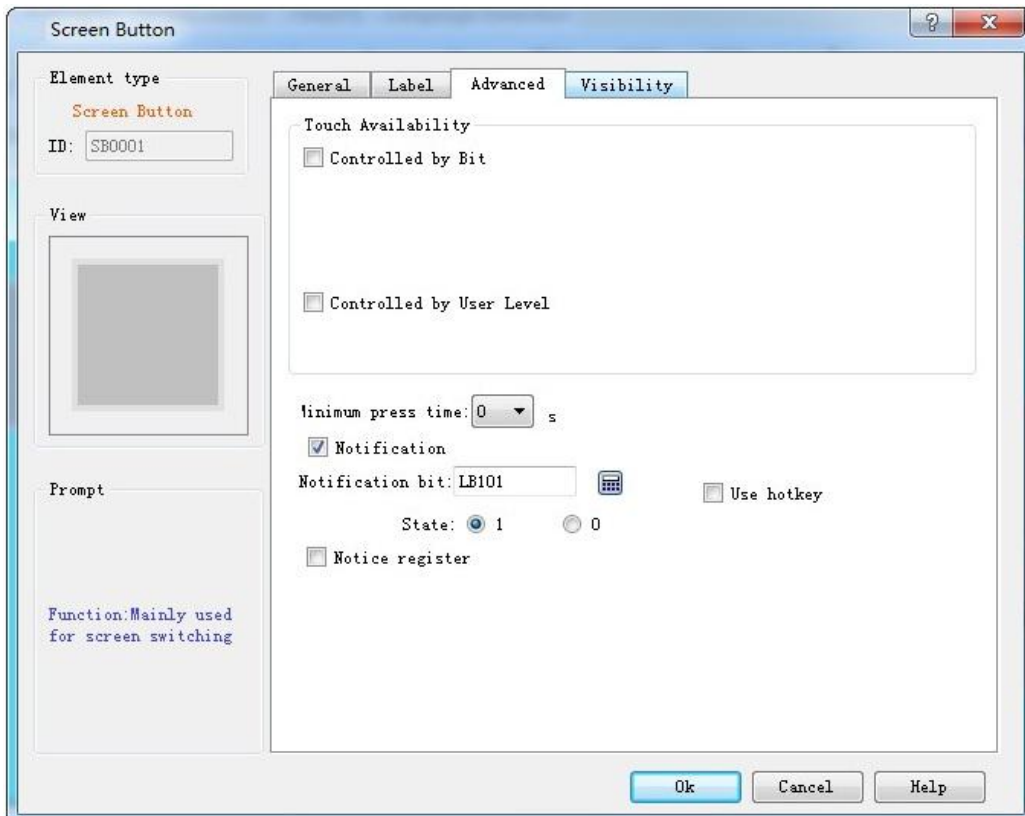
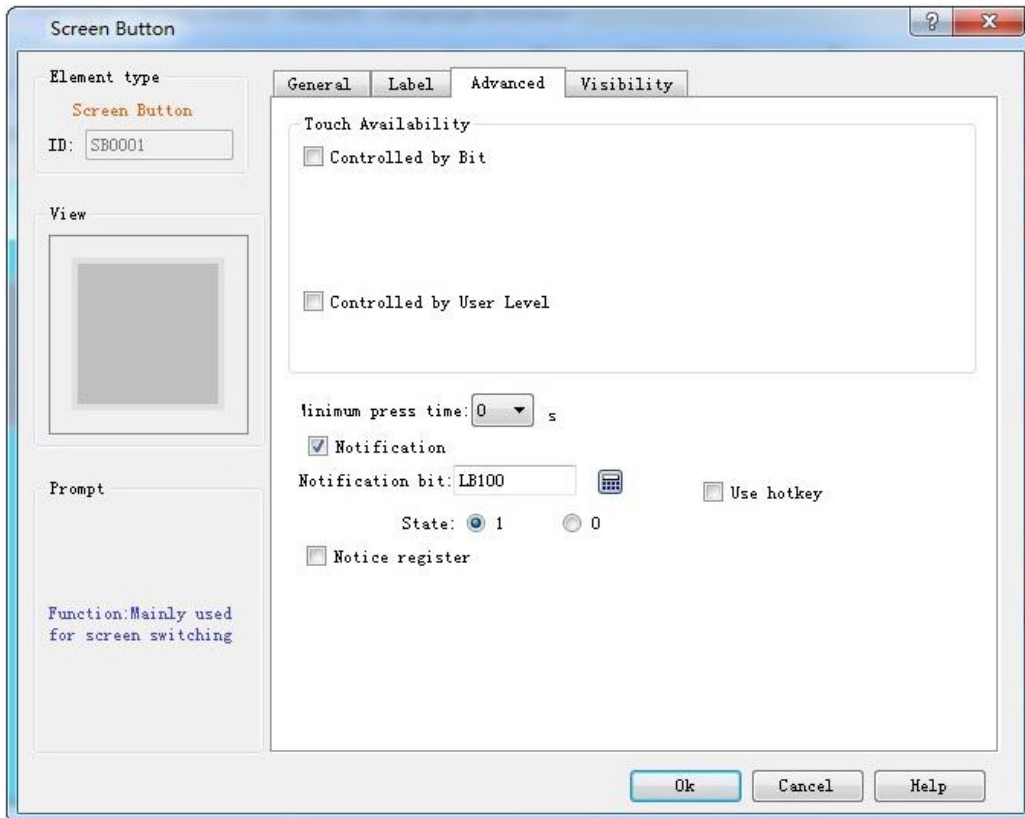

Global script setting:

Global Script ? X

| Global Script Name |                   |
|--------------------|-------------------|
| 1                  | Marco_COM->[ID:0] |
| 2                  | Marco1->[ID:1]    |
| 3                  |                   |
| 4                  |                   |
| 5                  |                   |
| 6                  |                   |
| 7                  |                   |
| 8                  |                   |
| 9                  |                   |
| 10                 |                   |
| 11                 |                   |
| 12                 |                   |
| 13                 |                   |
| 14                 |                   |

By Bit Contro Control Bit: LB100 

Frequency: 100  ms

Ok Cancel

Global Script ? X

| Global Script Name |                   |
|--------------------|-------------------|
| 1                  | Marco_COM->[ID:0] |
| 2                  | Marco1->[ID:1]    |
| 3                  |                   |
| 4                  |                   |
| 5                  |                   |
| 6                  |                   |
| 7                  |                   |
| 8                  |                   |
| 9                  |                   |
| 10                 |                   |
| 11                 |                   |
| 12                 |                   |
| 13                 |                   |
| 14                 |                   |

By Bit Contro Control Bit: LB101 

Frequency: 100  ms

Ok Cancel



---

**Code of Marco\_COM:**

```
#include "MacroInit.h"

void Macro_main(IN *p)
{
    MacroInit

    LW60297=0;

    LW60298=3;

    LW60299=0;

    LW60300=1;

    LW60302=1;

    char Pdata[20];

    char Gdata[100];

    int result;

    if (LB0==0) // 0 means state of sending; 1 means state of waiting reception
    {
        Pdata[0]=LW200;

        Pdata[1]=LW201;

        Pdata[2]=LW202;

        Pdata[3]=LW203;

        PUTCHARS(0,Pdata,4);

        LB0=1; //

        return; //
    }

    else

    {

        result=GETCHARS(0,Gdata);

        LW0=result;

        if (result<=0) // 0 means no reception while 1 means wrong reception
```

---

```

    {
        LW1++; // timeout, start to count
        if (LW1>=3) // Wait for execution time of 3 macros
        {
            LW1=0; // zero clearing
            LB0=0; // send the mark of zero clearing; send it the next time
        }
        return; // quit directly
    }
    else // correct reception
    {
        LW2=Gdata[0]&0xff; // data reception processing
        LW3=Gdata[1]&0xff;
        LW4=Gdata[2];
        LW5=Gdata[3];
        LB0=0; // processing completed; send it the next time of entrance
        PUTCHARS(0,Pdata,0); //clear buffer
    }
}

```

**Code of Macro1:**

```

#include "MacroInit.h"
void Macro_main(IN *p)
{
    MacroInit
    LW60297=0;
    LW60298=4;
    LW60299=0;
    LW60300=1;

```

---

```

LW60302=2;

char Pdata[20]; //send data and save arrays

char Mdata[100]; //receive data and save arrays

int result; //length of received returning data

if (LB0==0) //LB0 stands for sending accepted flag, 0 for state of sending and 1 for state of
waiting reception
{
    Pdata[0]=0x02; //send data, read holding register and the first byte is the address of slave
station

    Pdata[1]=0x03; //function code; read holding register

    Pdata[2]=0x00; // starting address of data to be read

    Pdata[3]=0x00;

    Pdata[4]=0x00; //word length of data to be read

    Pdata[5]=0x03;

    Wcrc=CRC(Pdata,6); //CRC check the previous data

    Pdata[6]=(Wcrc&0xff); //execute high-low interchange of CRC; P6 takes the low one

    Pdata[7]=(Wcrc>>8); //P7 takes the high one

    PUTCHARS(0,Pdata,8); //send function; send the whole data to serial port

    LB0=1; // complete sending; wait for reception instead of sending the next time of entrance

    return; //quit to wait for reception
}

else
{
    result=GETCHARS(0,Mdata); //receive function; save the received data to Gdata array

    LW0=result; //check the receiving length

    if (result<=0) //0 means no reception while 1 means wrong reception
    {
        LW1++; //timeout; start to count

        if (LW1>=3) //wait for execution time of 3 macros
        {

```

---

```
        LW1=0; //zero clearing
        LB0=0; //send the mark of zero clearing; send it the next entrance
    }
return; //quit directly
}
else //correct reception
{
    LW400=Mdata[0]&0xff; //data reception processing
    LW401=Mdata[1]&0xff;
    LW402=Mdata[2];
    LW403=Mdata[3];
    LW404=Mdata[4];
    LW405=Mdata[5];
    LW406=Mdata[6];
    LW407=Mdata[7];
    LW408=Mdata[8];
    LW409=Mdata[9];
    LW410=Mdata[10];
    LB0=0; //processing completed; send it the next entrance
    PUTCHARS(0,Pdata,0); //clear buffer
}
}
}
```



Name and address of variable setting are the same in function compile box.

---

## 15.3 Historical Data Collector Case

---

The following example illustrates the combined application of Historical Data Collector, Historical Data Display and Historical Trend Graph.

### 1. Create new historical data collector

Right click the "Historical Data Collector" in the "Project Manager" to create a new one, as shown in Figure 1 below

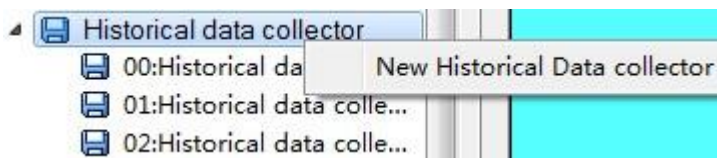

Figure 1 Create a new historical data collector

### 2. Settings of Historical data collector

Double click to open Historical data collector, as shown in Figure 2

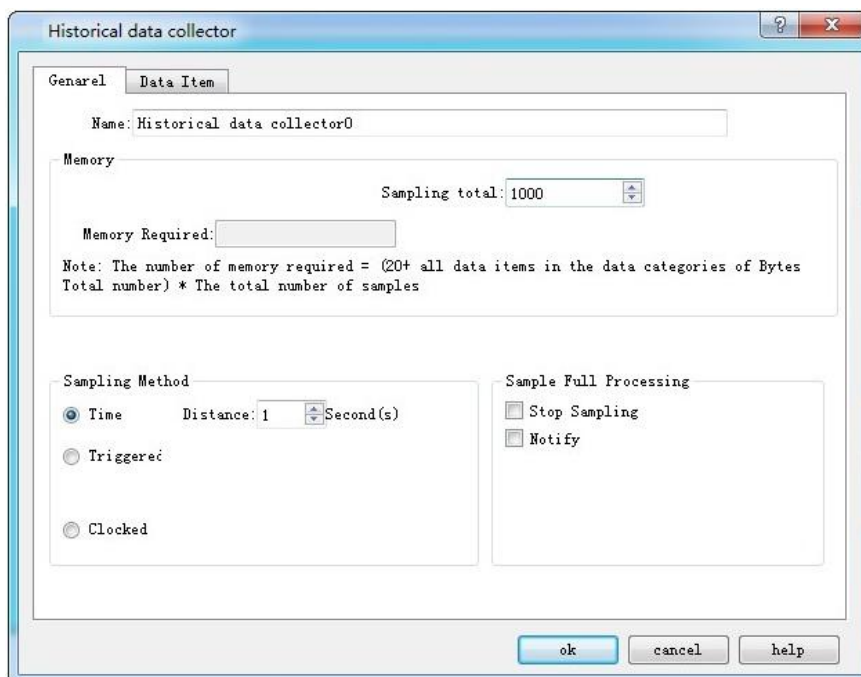

Figure 2 General settings of Historical data collector

Here, we add five data collection items named "Data1", "Data2", "Data3", "Data4" and "Data5" whose addresses are set to "LW0", "LW1", "LW3", "LW5", "LW6"; set up the data type and name for each, as shown in Figure 3. Since the data 2 and data 3 are 32-bit, it will read the register values of the "LW0", "LW1 + LW2", "LW3 + LW4", "LW5" and "LW6" every time it takes sample. The total sampling here is set to 1000, that is, take a total of 1000 samples, until it is full.

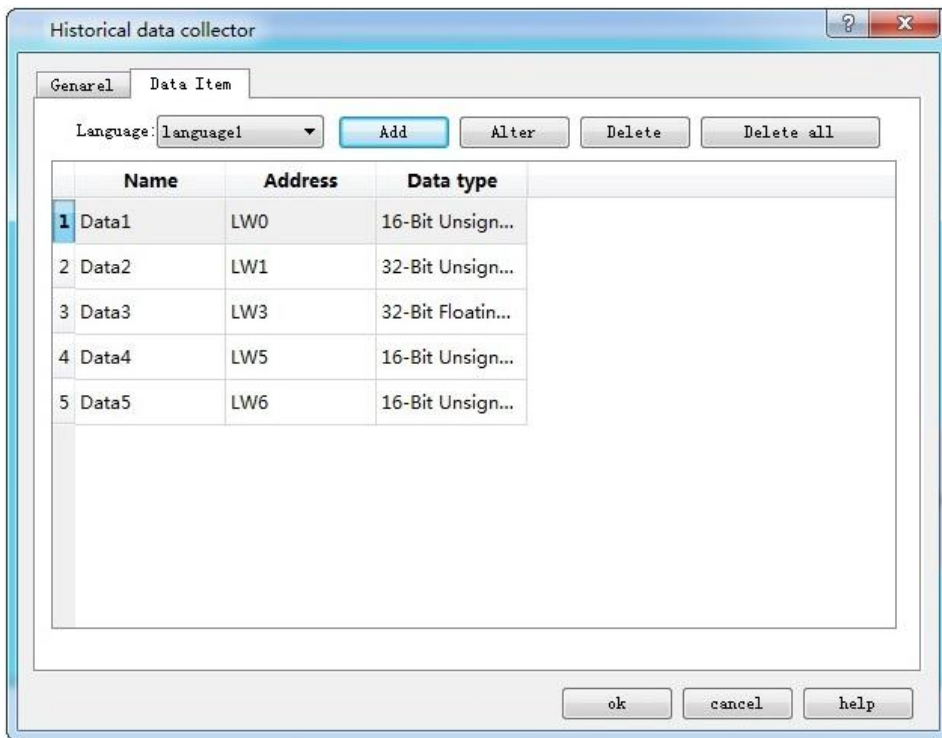

Figure 3 Data item setting of Historical Data Collector

Click "OK" button; after settings, execute "Historical data display" if you want to view the historical data.

**3. Settings of Historical data display:**

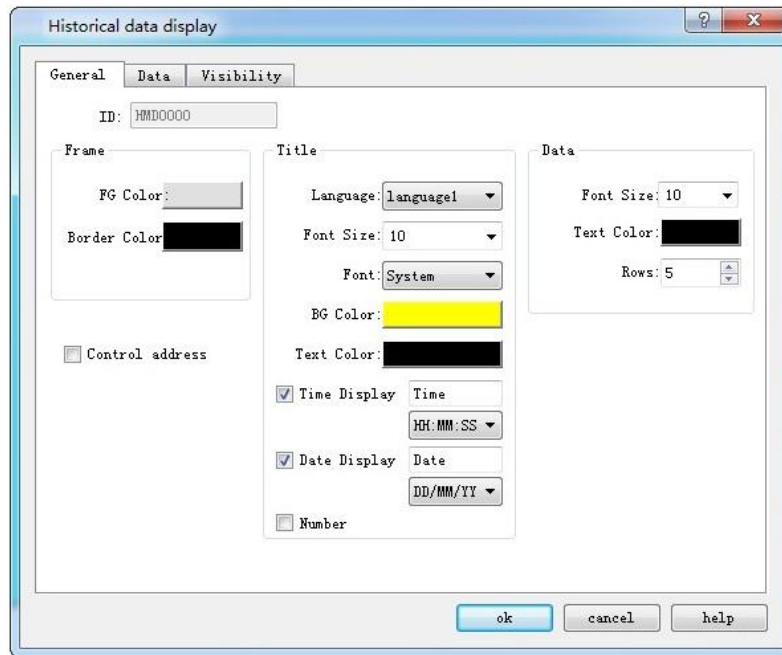

Figure 4 General settings of Historical data display

Select five for Display lines; Font and Background are up to you.

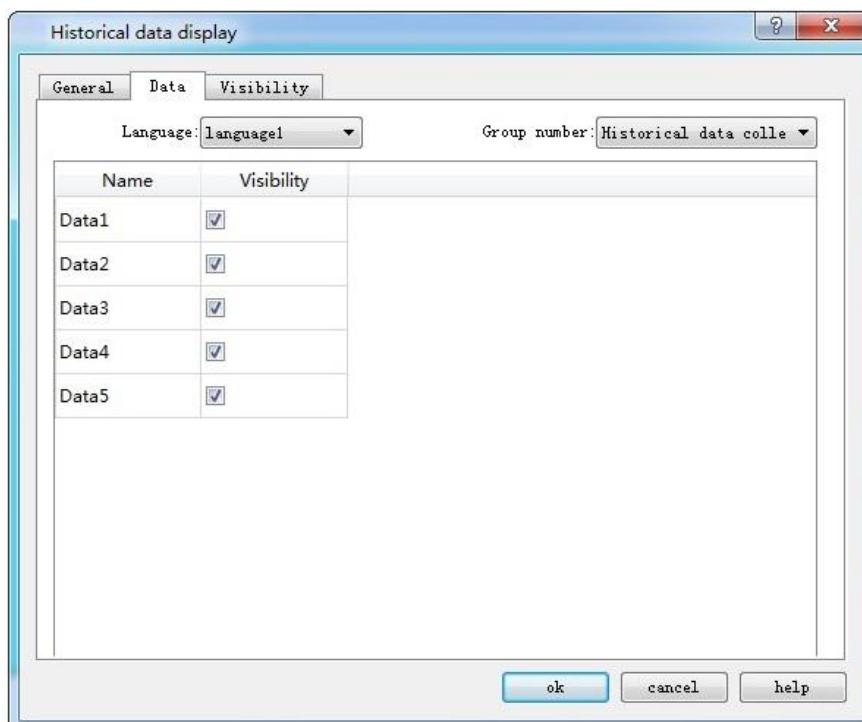

Figure 5 Data item settings of Historical data display

---

Check the data to be displayed; click “OK” button to complete; then a table appears on the screen, as shown below:

| Time | Date | Data1 | Data2 | Data3 | Data4 | Data5 |
|------|------|-------|-------|-------|-------|-------|
|      |      |       |       |       |       |       |
|      |      |       |       |       |       |       |
|      |      |       |       |       |       |       |
|      |      |       |       |       |       |       |

Figure 6 Historical data display on the screen

Employ “Historical trend chart” to display the value change if it is needed.

**4. Open Historical trend chart, as shown below**

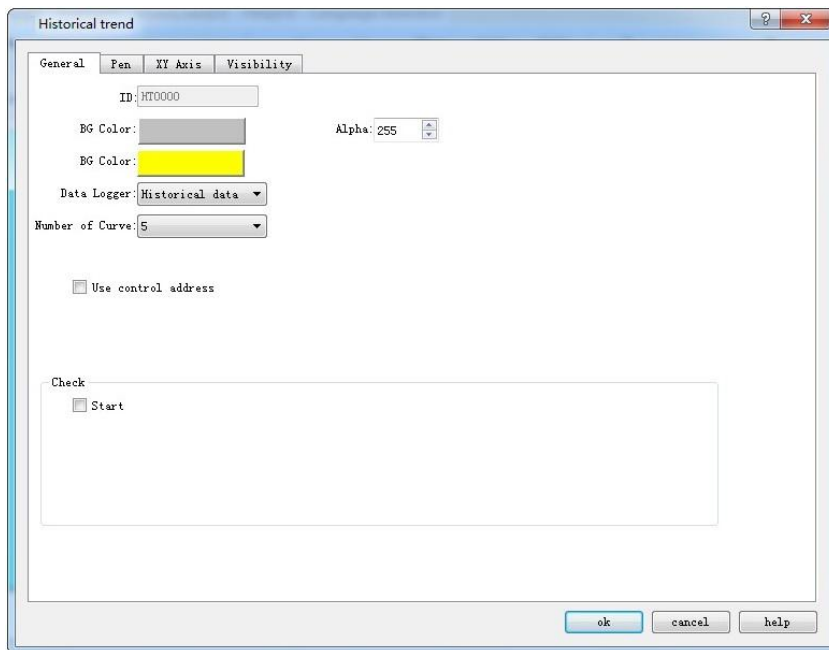

Figure 7 General setting of Historical trend chart

**It needs to select the number of line to be displayed and its data source as well as color.**



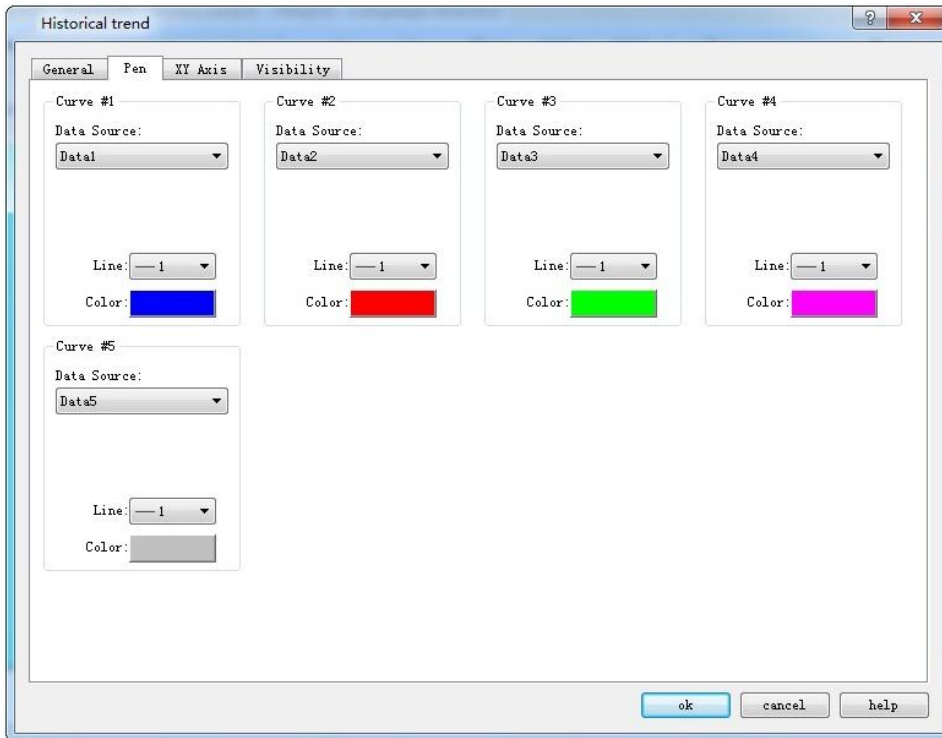

Figure 8 Line settings of Historical trend chart

Set the maximum value and time at XY axis.

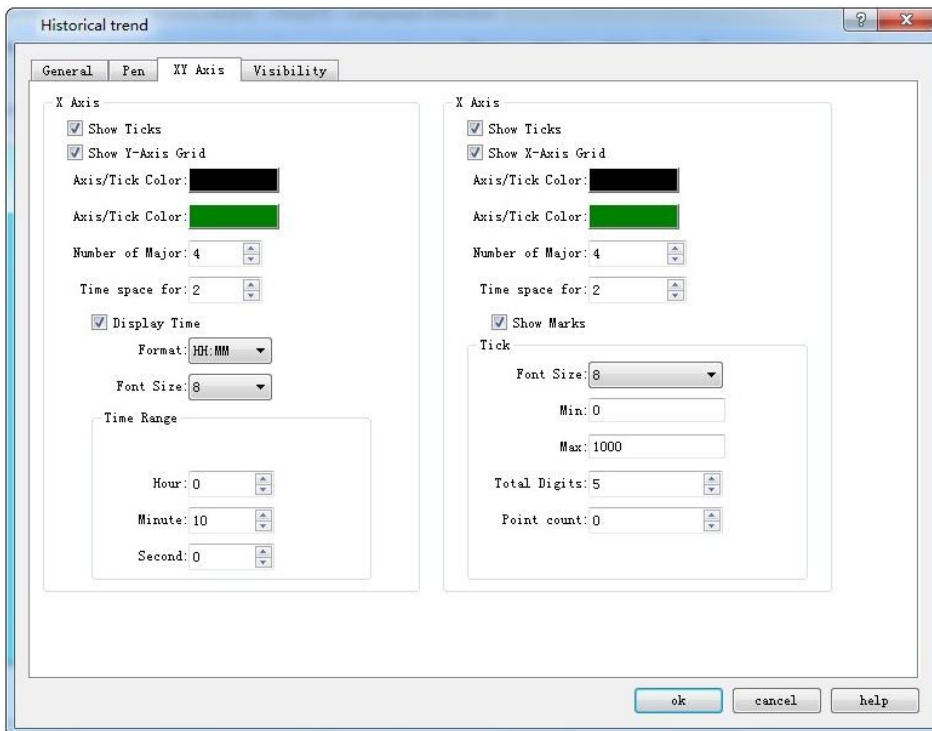

Figure 9 XY axis settings of Historical trend chart

Click "OK" button to complete; draw the trend chart as shown below:

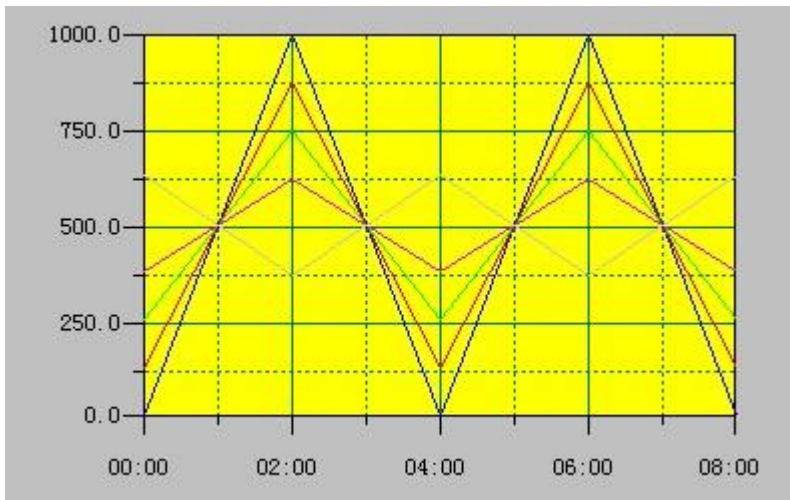

Figure 10 Historical trend chart display on screen

## 15.4 Recipe Case



The following example shows the settings and display mode of recipe.

### 1. Create a new recipe

In the project manager, right click on the recipe, as shown in Figure 1:

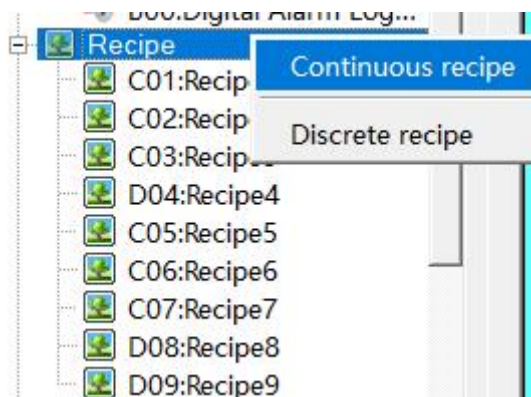

Figure 11 Create new recipe

Double click to open the recipe, as shown in Figure 2:

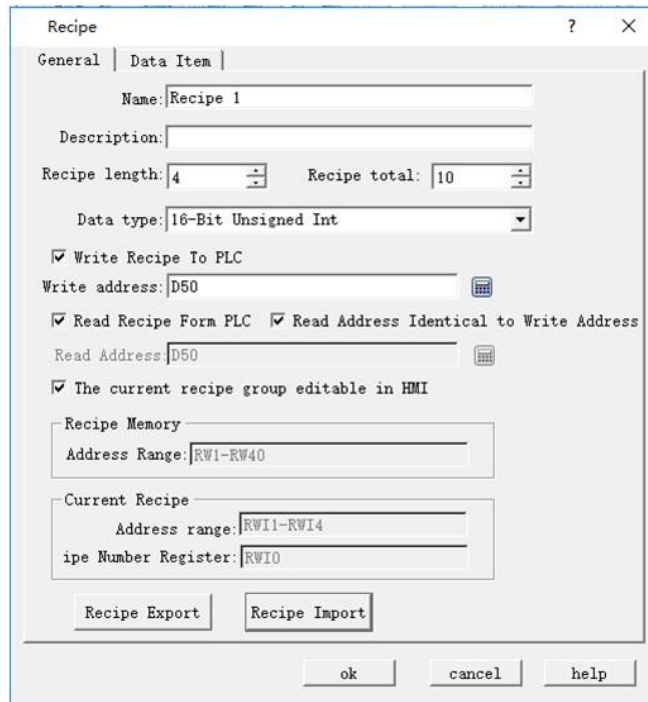

Figure 12 General settings of Recipe

Set the recipe length to 4, which means each recipe contains 4 data. The total number is 10, that is, 10 recipes. Set the address for writing recipe to PLC to D50, and select the 16-bit positive integer; write the recipe to the register D50, D51, D52 and D53. Settings are the same as that of the write address.

## 2. Data item setting of Recipe :

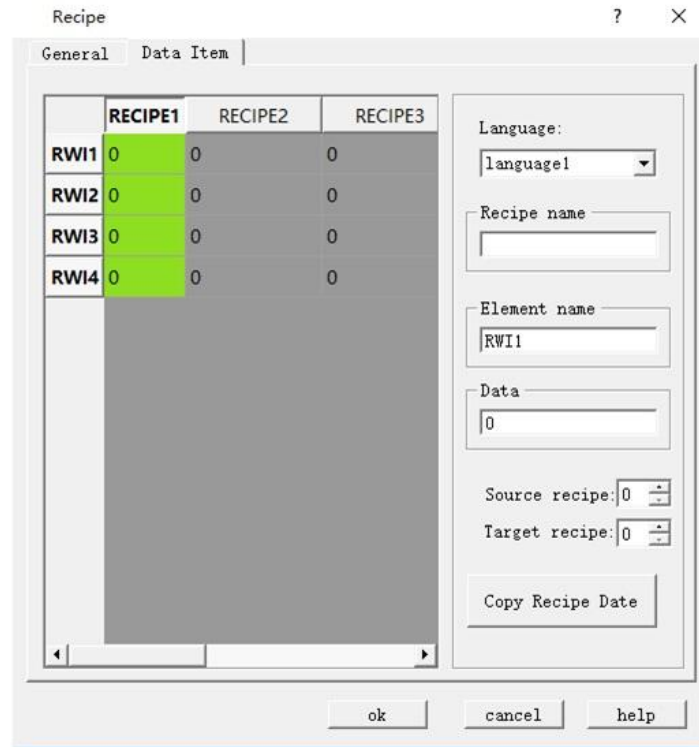

Figure 13 Data item settings of recipe

After setting the recipe name, select "OK" to complete. Employ Numeric Input and Display control to display recipe data on the touch screen. Select the internal memory address RWI0 for the numerical display and input control; serial number of recipe is the value of input and display. The value of RWI 0 stands for the serial number of recipe; value of 2 means serial number of recipe 2, and so on. Employ the Numeric Input and Display control to display data from D50 to D53. You can execute functions of "Function button" for saving or reading a recipe. For details, refer to "Function button".

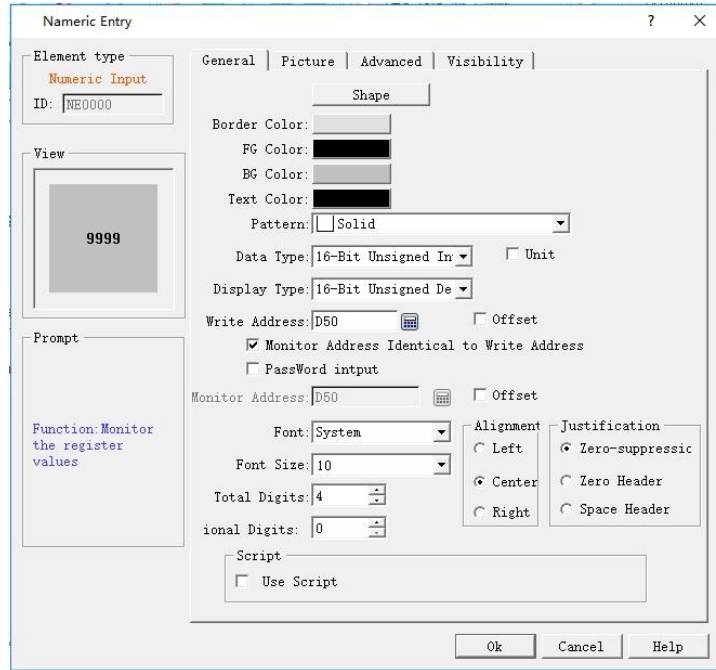

Figure 14 “Numerical input and display” control for recipe data D50

Set up the Numerical input and display control and place it on the screen :

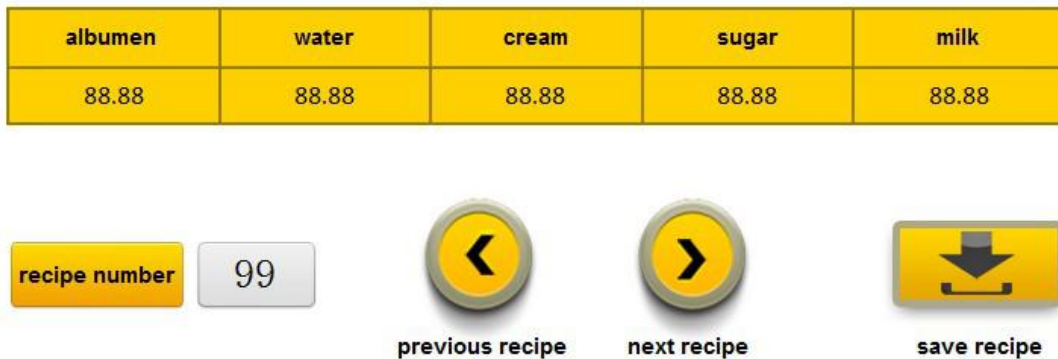

Figure 15 Screen view of Recipe display

It can change recipe parameters via Numerical input and display; realize functions of checking recipe, reading recipe and writing recipe through function buttons.

## 15.5 Digital Alarm Login

Alarm Setting is employed to display alarm information, only with which the alarm control and alarm bar run normally (in fact, the alarm control and alarm bar displays the alarm message of "digital alarm login" and "analog alarm login").

Right click the "Alarm landing" in the Project Manager and select "New digital alarm", as shown in Figure 7-22:

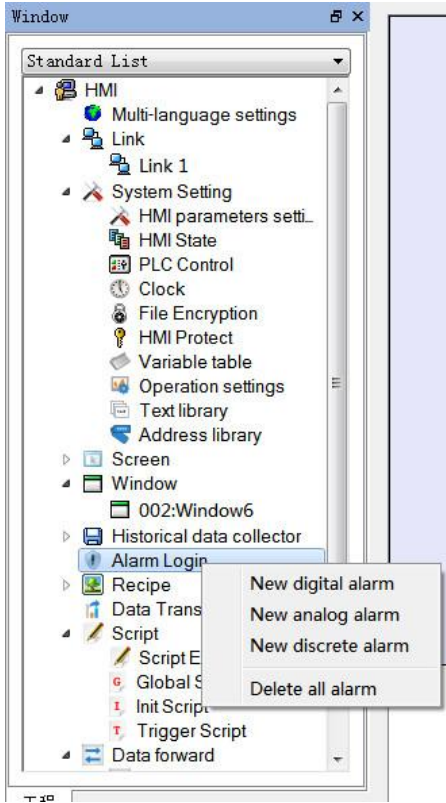

Figure 7-22 Select alarm log

Double click the "digital alarm login" option to open the digital alarm settings dialog box, as shown in Figure 7-23:

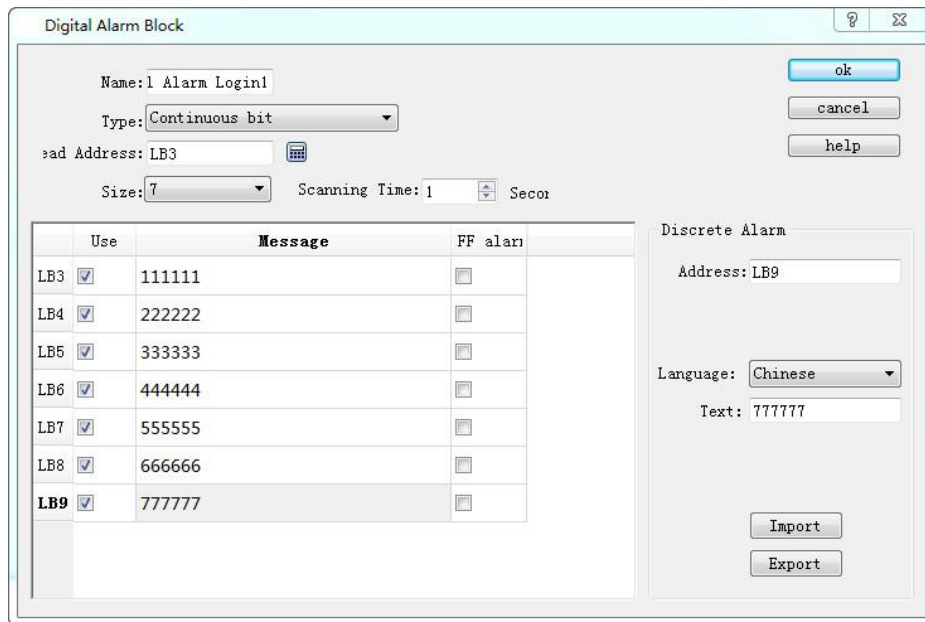

Figure 7-23 Select continuous digit

Steps to build a digital alarm log are as follows:

- Enter the read address first; it is assumed here that the internal address LB1 is set.
- In the "Size" column, select the total number of alarms, i.e. the total number of bit addresses, which is continuous. It is assumed here that the set value is six.
- Set the bit alarm "Scanning time", that is, the scanning frequency.
- Click an item in the list box, and then move the mouse to the right of the "Message" module; input text information in the "Text" edit box serving as the alarm content. Here assume that the alarm messages are as shown in Figure 7-23.
- If "Use" is selected, the alarm information will be displayed in "Alarm Control" or "Alarm Bar". Otherwise the alarm message will not appear even if the corresponding address is 1. If the address value of this item is 0, the alarm information does not show.
- OFF Alarm: When this option is selected, the alarm will be generated when the corresponding address value is 0 (OFF value). Otherwise, an alarm will be generated when the address value is 1 (ON value). By default, an alarm occurs when the address value is 1 (ON).
- U export: export alarm settings information
- U import: import alarm settings information

Here is an example: Suppose the choice of type is "Continuous bit".

- If the value of LB1 address is 0, the alarm information will not be displayed in "Alarm Control" and "Alarm Bar", regardless of whether the "Use" option is selected or not.
- If the value of the LB1 address is 1 and the "Use" option is not selected, the alarm information is not displayed in the "Alarm Control" and "Alarm Bar".
- If the value of LB1 is 1 and the "Use" option is selected, the alarm information will be displayed in "Alarm Control" and "Alarm Bar".

Click "OK" to complete digital alarm settings. Users can add 6 bit buttons with the function of Alternation whose address is LB1-LB6; place controls of "Alarm" and "Alarm Bar" on the screen; then execute offline simulation to check whether it displays alarm information.

The following is an example of offline simulation as shown in Figure 7-24:

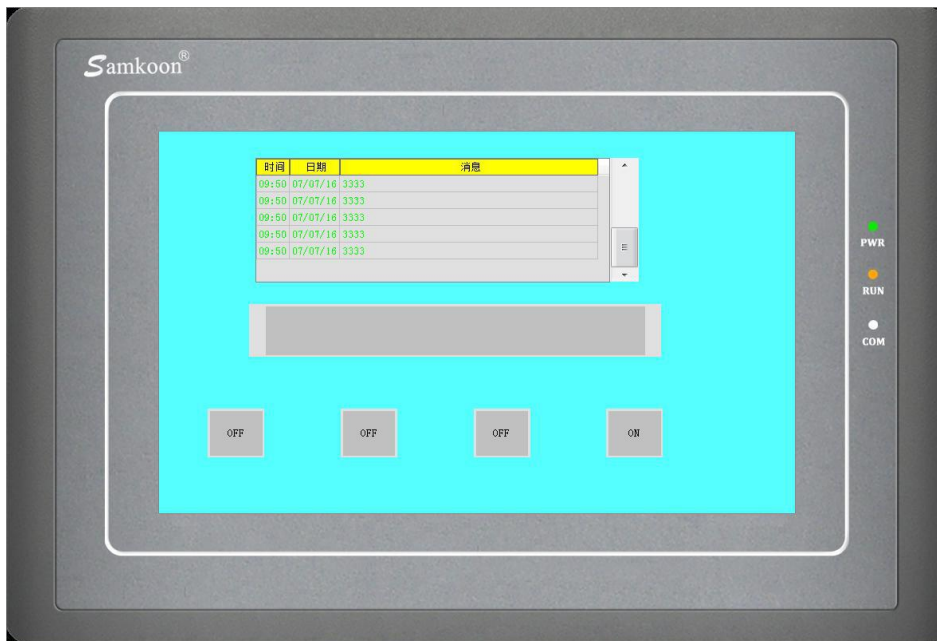

Figure 7-24 Offline simulation example of digit alarm

When "Continuous Bit of Word" is selected as the Type, as shown in Figure 7-25 below:



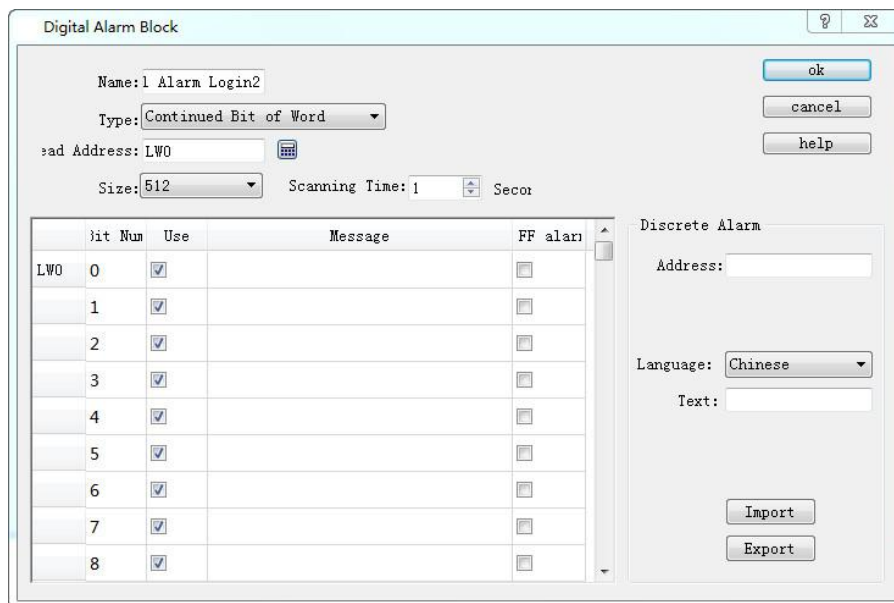

Figure 7-25 Select Continuous Bit of Word

If the “Use” of a certain bit number is selected, an alarm will be generated when the value of this bit value is 1.



Note: When copying the contents of alarm messages from other documents to the alarm text of digital alarm log and analog alarm log, please make sure that there is no line break (invisible) in the message. It is recommended to input the message manually rather than copy and paste, in case of display error of alarm message.

If "Word value" is selected for the type, as shown in Figure 7-26 below:

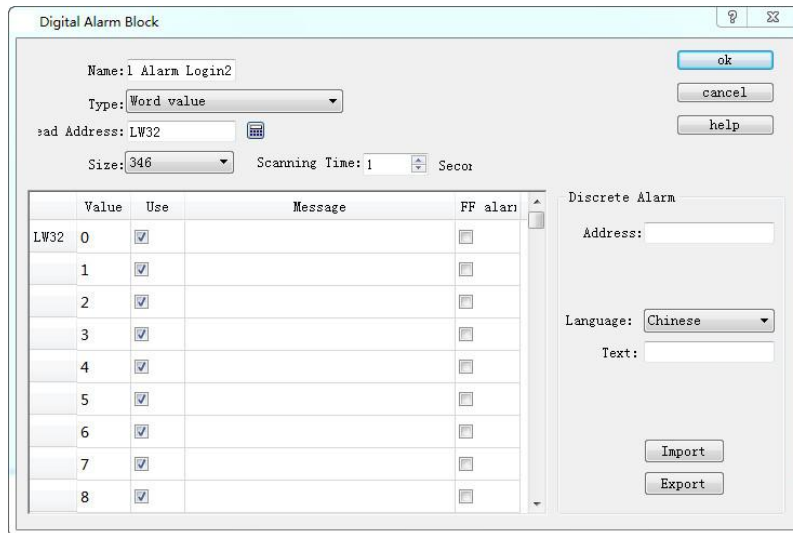

Figure 7-26 The "Word Value" digital alarm dialog box

When a value of the address is selected, the alarm is generated when the value of the address is equal to the value selected in the list.

Place an Alarm control with 7 lines as the example in Figure 7-24 and a Dynamic alarm bar whose attributes are set as shown in Figure 7- 27:

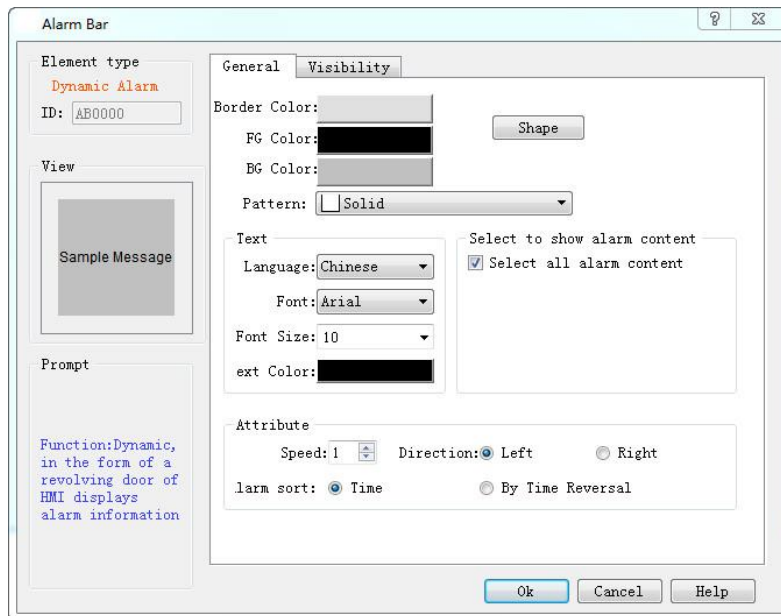

Figure 7-27 Dynamic Alarm Bar Properties dialog box

Add lastly six bit buttons whose write address is LB1-LB6 with the "Alternation", "Monitor" and "Monitor Address identical to Write Address" functions set for each. After the settings, click the

"Save" button on the toolbar to save the project, execute the "Offline" command in the "Download" item in the menu bar, and then click the bit buttons LB1, LB2, LB4 and LB6. In this case, the Alarm control and Dynamic Alarm Bar will display the alarm information of LB1, LB2, LB4, and LB6 in the "Digital Alarm" When click them again, "Alarm Control" and "Dynamic Alarm Bar" will display nothing since their values are 0 because of the alternation function.



Note: Different alarm information is available for corresponding language through the function of switching language.

Note: Number of digital alarm is up to 10 for SK series HMI.

## 15.6 Analog Alarm Login

Open the analog alarm settings dialog box, as shown in Figure 7-28:

It has two types: Numerical value and Numerical comparison.

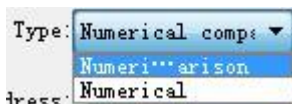

The numerical comparison alarm is as shown below:

| Use   | Message         |
|---|-----------------|
| <input checked="" type="checkbox"/> Low Low   | <10             |
| <input checked="" type="checkbox"/> Low       | 10 <= LW1 < 50  |
| <input checked="" type="checkbox"/> High High | 100 < LW1 < 150 |
| <input checked="" type="checkbox"/> High      | >150            |

Figure 7-28 Analog Alarm Login dialog box

If user needs to use the analog alarm, steps are as follows:

- First input the address in the "Read Address" column to alarm. It is assumed here that the internal address LW1 is set.
- Select the total number of alarms in the "Size" option, which means the total number of addresses; data type decides the way to read address. Each address value is set firstly as the 16-bit data type and it is continuous. But the data type can be changed. As shown in Figure 7-28, the LW1 address chooses a 32-bit positive integer while LW3 and LW4 values are 16-bit positive integers. Therefore, when 32-bit data is selected for an address, the later address value to be read is added by 2 on the basis of the former address value; and if the 16-bit data type is selected, the later address value to be read is the former value plus 1.
- Users can set the "Scanning time" of the alarm, which means the scanning frequency.
- Click each item to input a value in the "Limit" box on the right; then enter the text information (alarm content) in the "Text" box. Here assume that the message is as shown in Figure 7-28: each address value can be classified into one of four ranges-- Low, Low Low, High, High High.

As shown in Figure 7-29:

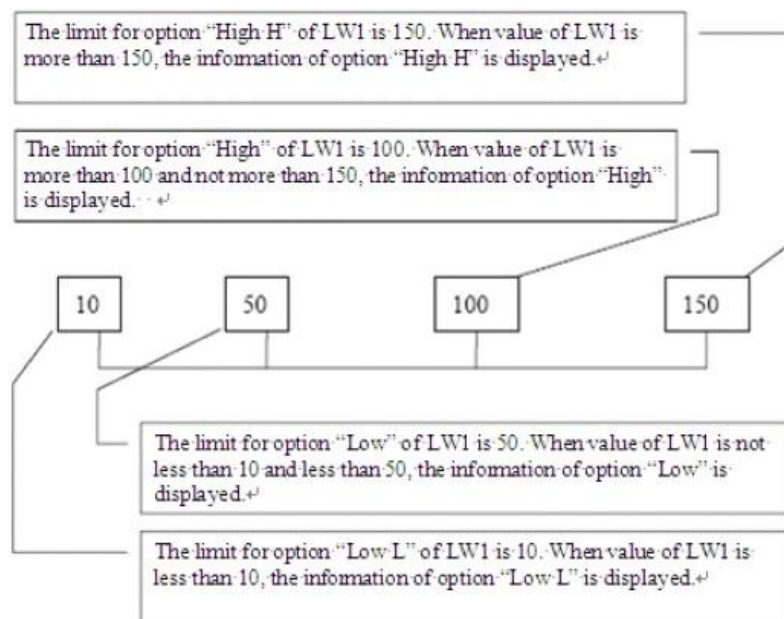

Figure 7-29 Diagram of the four address values for the LW1 address

- Low Low: When the value of this item is less than the limit of this setting and the "Use" option is selected, the alarm information of this item will be displayed in "Alarm Control" or "Dynamic Alarm Bar";
- Low: When the value of this item is no less than the "Low Low" limit while less than the "Low" limit and the "Use" option is selected, the alarm information of this item will be displayed in "Alarm Control" or "Dynamic Alarm Bar";

- High: When the value of this item is greater than the “High” limit while no greater than the “High High” limit and the "Use" option is selected, the alarm information of this item will be displayed in "Alarm Control" or "Dynamic Alarm Bar".
- High High: When the value of this item is greater than the limit of this setting and the "Use" option is selected, the alarm information of this item is displayed in "Alarm Control" or "Dynamic Alarm Bar".
- U export: export alarm settings information
- U import: import alarm settings information

Refer to “Digital Alarm Login” for the application of “Use”.

Numerical value alarm means an alarm occurs when the value reaches the set limit value.

The settings are as follows: Alarm is triggered when the alarm value reaches 1, 12, 30 and 40.

|     | Use   | Message |
|-----|---|---------|
| LW1 | <input checked="" type="checkbox"/> Value 1 | 1       |
|     | <input checked="" type="checkbox"/> Value 2 | 12      |
|     | <input checked="" type="checkbox"/> Value 3 | 30      |
|     | <input checked="" type="checkbox"/> Value 4 | 40      |



Note: Number of analog alarm is up to 10 for SK series HMI.

## 15.7 Usb update PLC program

### U disk update PLC program

SK series touch screen support using U disk update Samkoon PLC program

**How to update Samkoon PLC program using usb flash drive**

#### 1. Compile Samkoon PLC U disk update file

Official website download the latest Samkoon PLC software, design the completion of the PLC program, click the following button, generate U disk update PLC required files



Generate the following U disk update file, copy to U disk root directory

|           |                  |        |        |
|-----------|------------------|--------|--------|
| data.bin  | 2018/12/24 17:55 | BIN 文件 | 140 KB |
| downc.bin | 2018/12/24 17:55 | BIN 文件 | 137 KB |

## 2. Add U disk to update Samkoon PLC function button

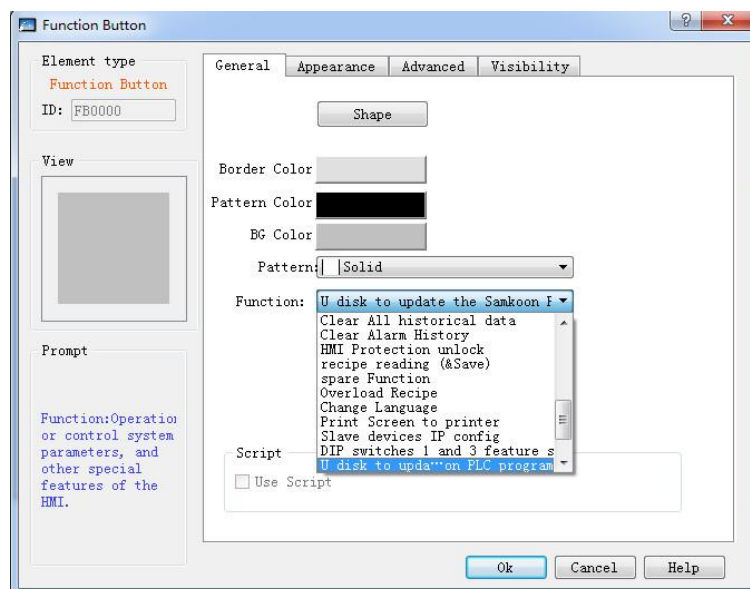

## 3. Update Samkoon PLC program

Click the button on the touch screen and the interface as shown in the figure below appears

---

Put the PLC file into the root directory of U disk and insert it into the touch screen

A) Select the corresponding serial port and set the corresponding communication baud rate  
B) Click the communication test to check whether the current communication parameters can communicate with the PLC normally. When normal, enter the next step of operation, and automatically switch the communication parameters if wrong. When communication succeeds, enter the next step of operation

C) Click download, enter the update Samkoon PLC program, observe the message prompt, update failure, according to the message prompt information to determine the cause of update failure, fix the cause of failure, need to click a restore factory operation, restore factory success from the first step to start again

D) When the update is complete, close the window

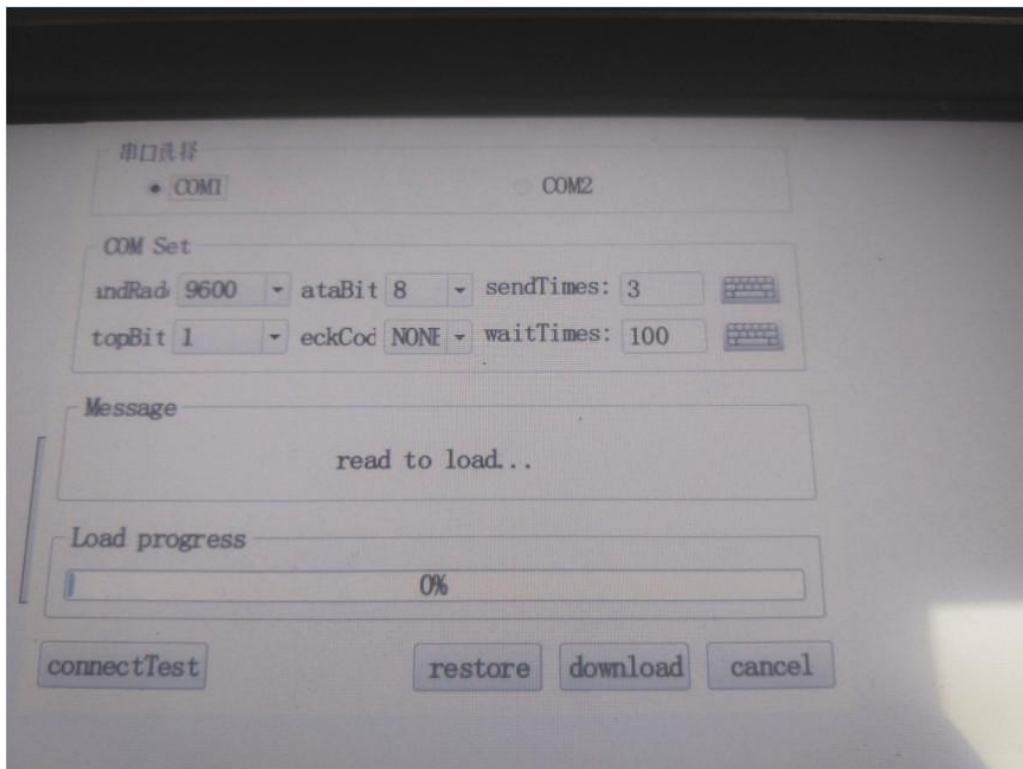

**COM choose:**

The serial port updates the samkoon PLC program, and temporarily only supports the serial port, which selects the connection between the touch screen and the PLC.

**COM set:**

Set touch screen and samkoon PLC communication port rate

**Message:**

Prompts for various information that appears in the update process

---

**Load progress:**

Prompt update of PLC program schedule

**Connect Test:**

Test touch screen and samkoon PLC can communicate normally, and the communication test will be able to perform normal update operation

**restore:**

When the error occurs in the update process, the advanced row is required to recover the factory and update the operation

**download:**

Update the samkoon PLC program

injection      ·Ensure that samkoon PLC updates the integrity of the files  
                  . Please consult whether Samkoon PLC software meets the requirements when there are problems in the update



---

## 16. Remote

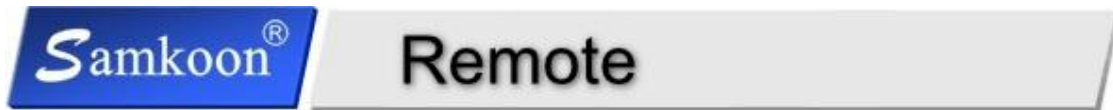

The touch screen supports remote function, this chapter details the attention and use methods in the use of remote functions.

- [Remote profile](#)
- [Remote configuration](#)
- [VNC function](#)
- [Remote case](#)

### 16.1 Remote profile



SK series Touch screen support remote function,The user can use the computer or the mobile phone side software to check the remote configuration of the touch screen after downloading the touch screen, the user can monitor the touch screen and the PLC operation state in real time, the detailed remote function introduces, the user can refer to the remote software help, and see more remote operation information.

SKThe remote function currently has only the following type of touch screen to support this function:

SK-070GG, SK-070GW, SK-070MG, SK-070MW, SK-102CG, SK-102CW

Instructions on different types of suffixes:

G:4G version

W:WIFI version

Please check the different types of touch screen parameters.

### 16.2 Remote configuration

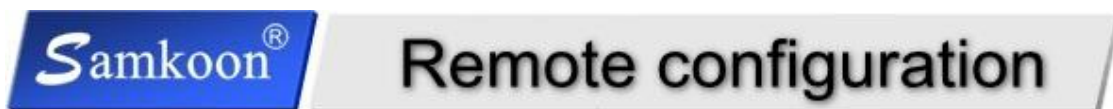

This chapter introduces the basic sequence of the SKTOOL software middle distance configuration

#### 1.Creation project

Currently, the sk series has the following touch screens to support remote functions, and when new configuration is built, the touchscreen selects one of the following models:SK-070GG,

SK-070GW, SK-070MG, SK-070MW, SK-102CG, SK-102CW

withSK-070GWFor example,The new project is shown in the following figure:

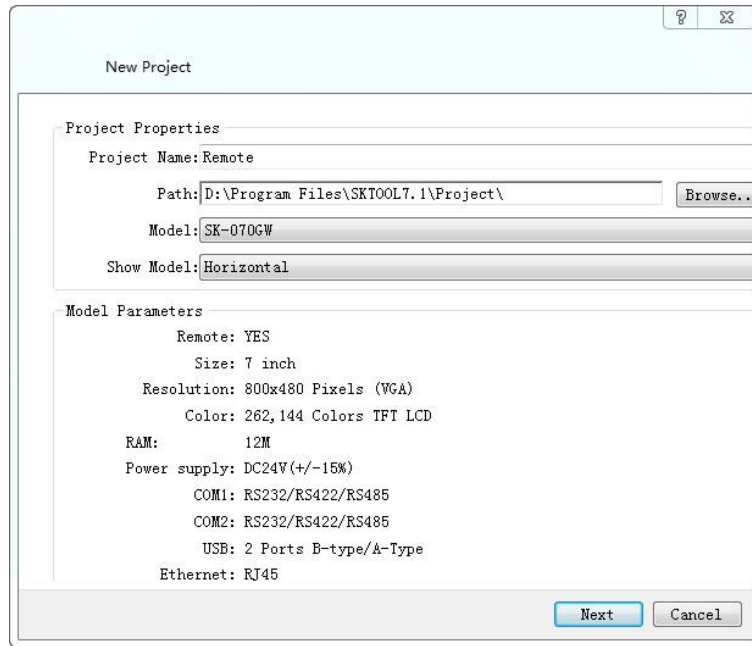

Select touch screen type

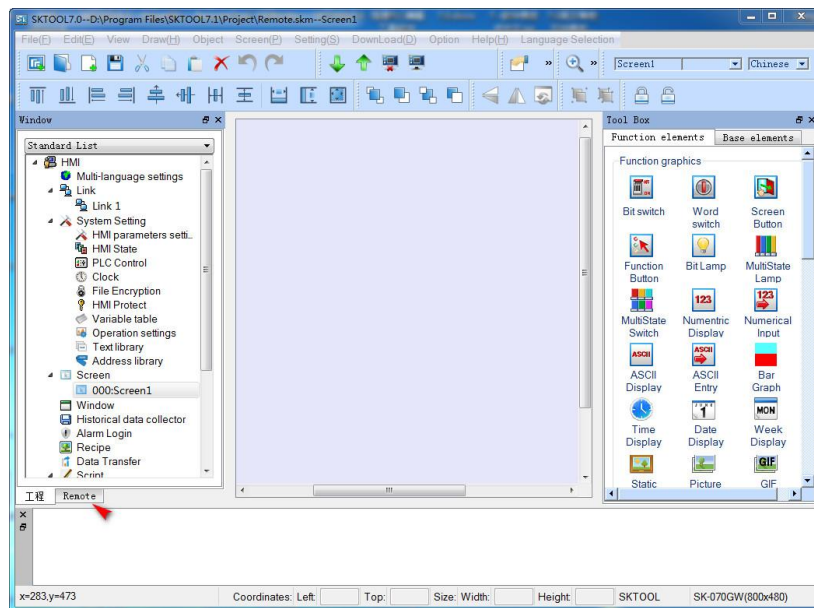

Engineering face

If the selected touch screen type supports the remote function, the configuration creation is completed, and there is a remote option in the engineering management device, which is used for remote image creation.

## 2.Remote setting

Jump to the remote interface as shown below

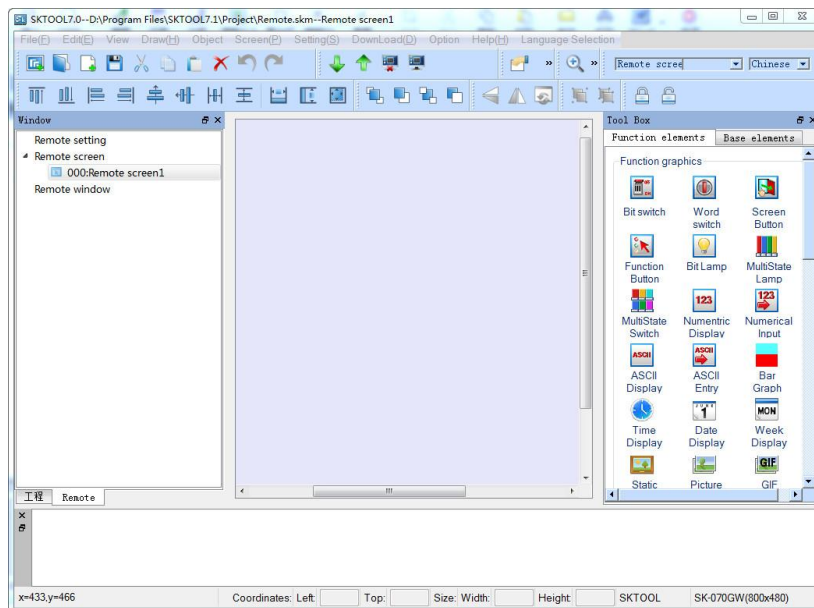

For remote engineering managers, users can refer to "Engineering manager"

Click remote Settings, set the remote device name and the connection password, and if not set the connection password, the download is prompted as follows

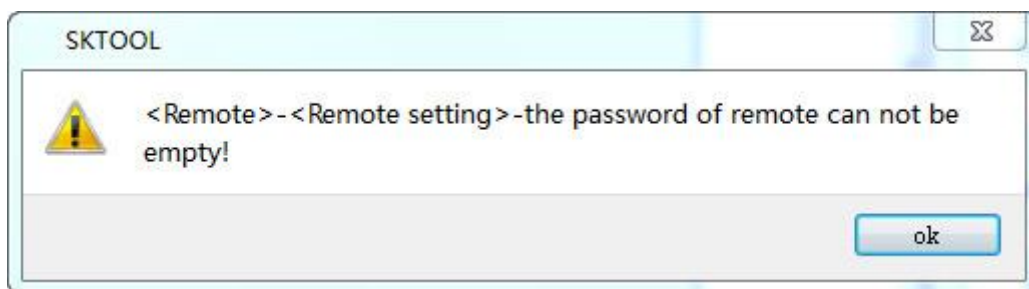

After the setup is complete, the user can add remote or remote Windows for remote monitoring

## 3.Configuration setting

The remote configuration image is the same as the touch screen configuration image creation process, and the remote configuration needs to be noted:

Remote alarm: The remote alarm currently only supports the discrete alarm, and the upload server is checked, and the data will be sent to the remote

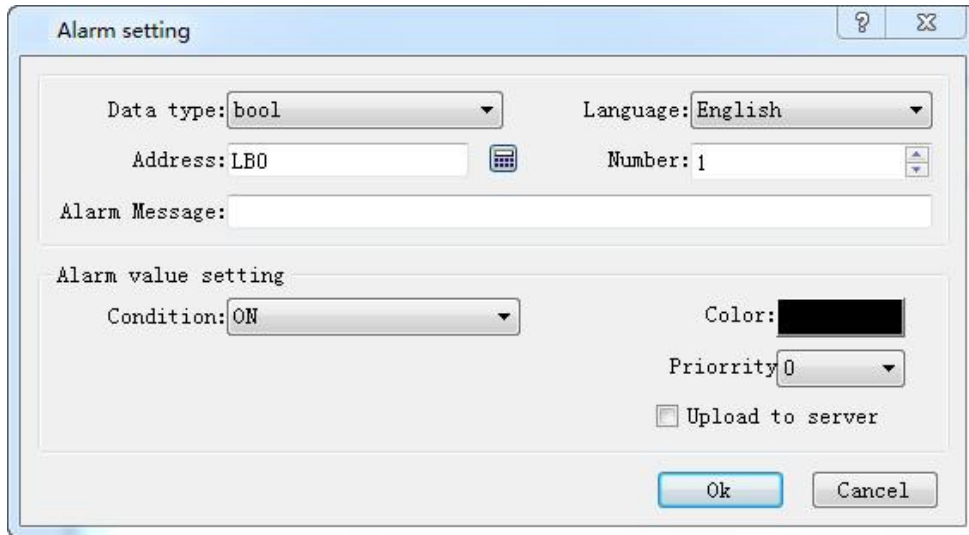

Control attribute: The remote configuration control attribute has a subtle difference to the touch screen group attribute, which can be seen in the shape, style, and address migration, and the macro instruction is the grey non-selected state. The relevant properties are not set in the remote configuration. The other controls are the same. The grey state properties are not set

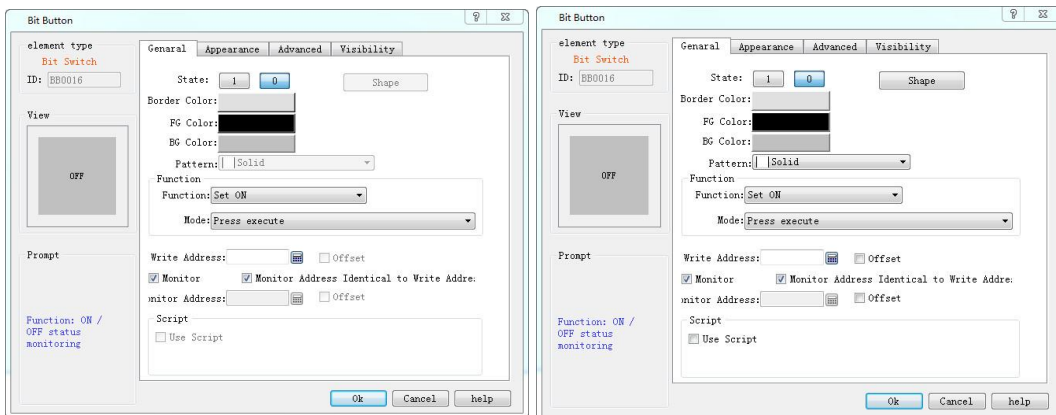

Remote bit control properties

Touch screen control properties

Control replication: It is important to note that the touchscreen configuration control is copied to the remote configuration control. The remote configuration USES the default property. The resulting control is copied to the remote configuration after the display effect is inconsistent with the original. For the remote configuration control is copied to the touch screen group state, the relevant properties are restricted, and the properties are free in the touch screen group, and the replication effect is shown in the figure below:

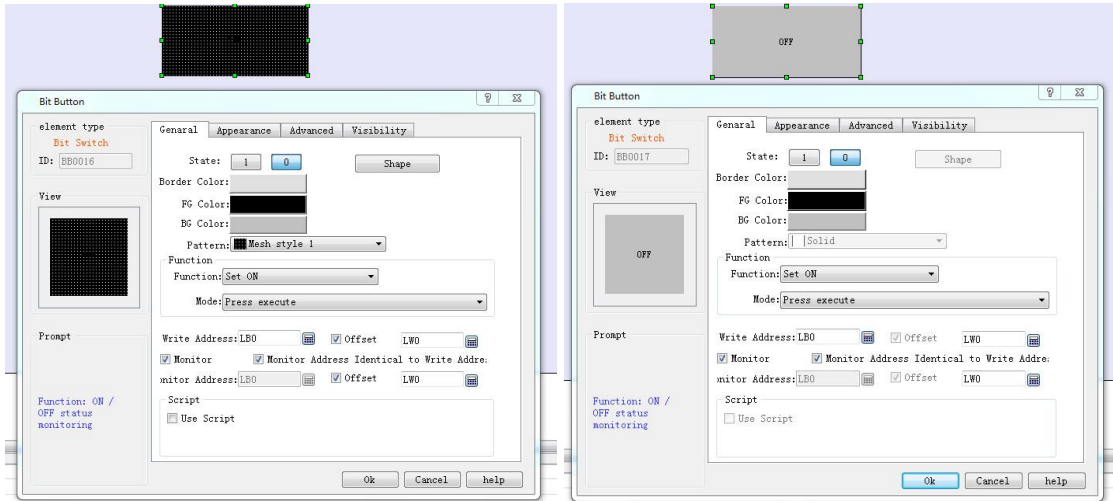

Prereplication

After replication

Control support: The remote configuration control is not fully supported by the touchscreen configuration control, and the unsupported control is in a grey non-selected state, as shown below:



#### 4. Configuration download

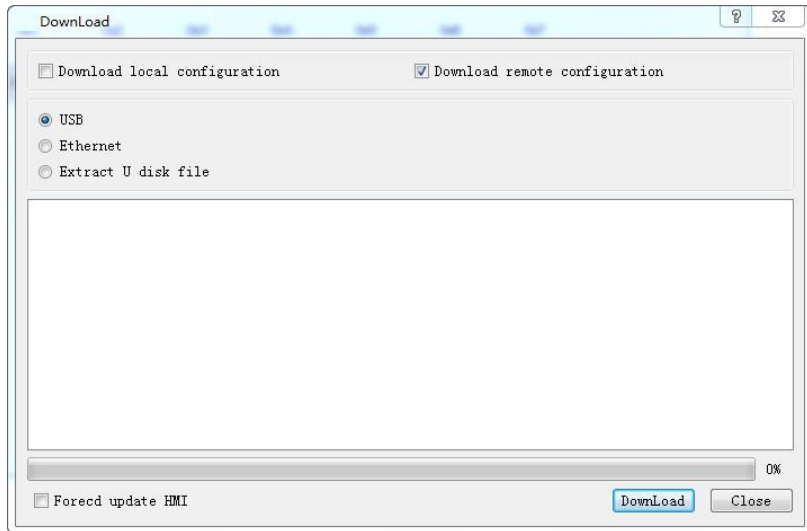

The same is the same as the download touchscreen configuration, but this is the option to download the remote configuration, the configuration download is complete, the touchscreen end is completed, and the user can connect the touch screen through the remote software.

### Remote engineering manager

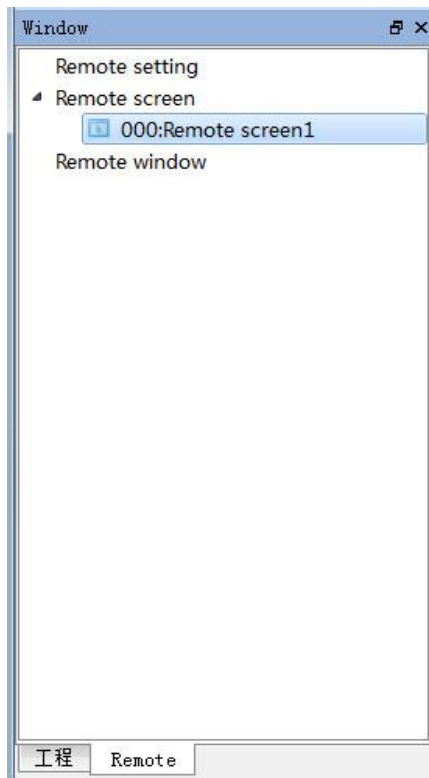

#### 1.Remote setting

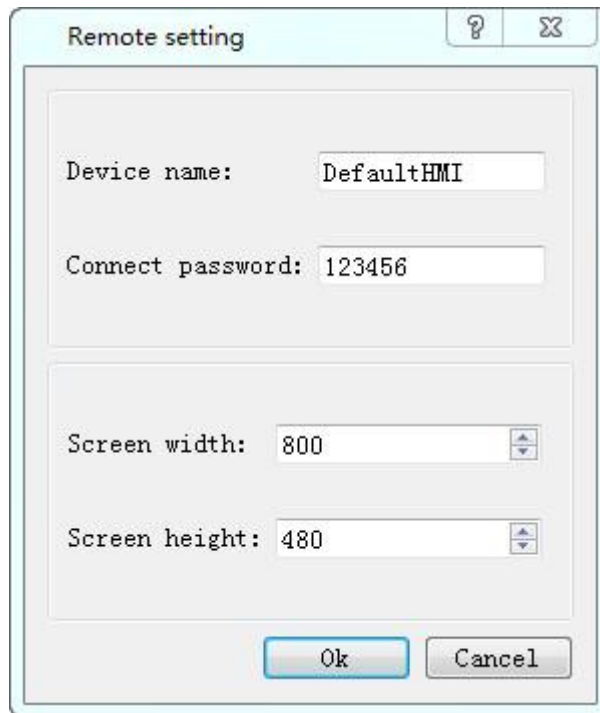

Remote Settings options:

Device name: user touch screen name when connecting to a remote connection

Connection password: must, remote client software enter the remote configuration time password option

The width of the image and the height of the image: the same as the sk image properties, set the configuration of the configuration area

2.Remote image

Add remote image

3.Remote window

Add remote window

return

## 16.3 VNC function



VNC remote monitoring capabilities, similar to Windows remote desktop features,Users can pass VNCS,Remote monitor touch screen

The VNC configuration is set in the touch screen parameter setting -the VNC interface Settings. The VNC port and the connection password are set correctly. The remote client software enters the correct password and can enter the remote monitoring interface. It can operate the screen interface remotely

Note: the current VNC port is fixed with 7530and cannot be modified to other values

VNC Setting interface

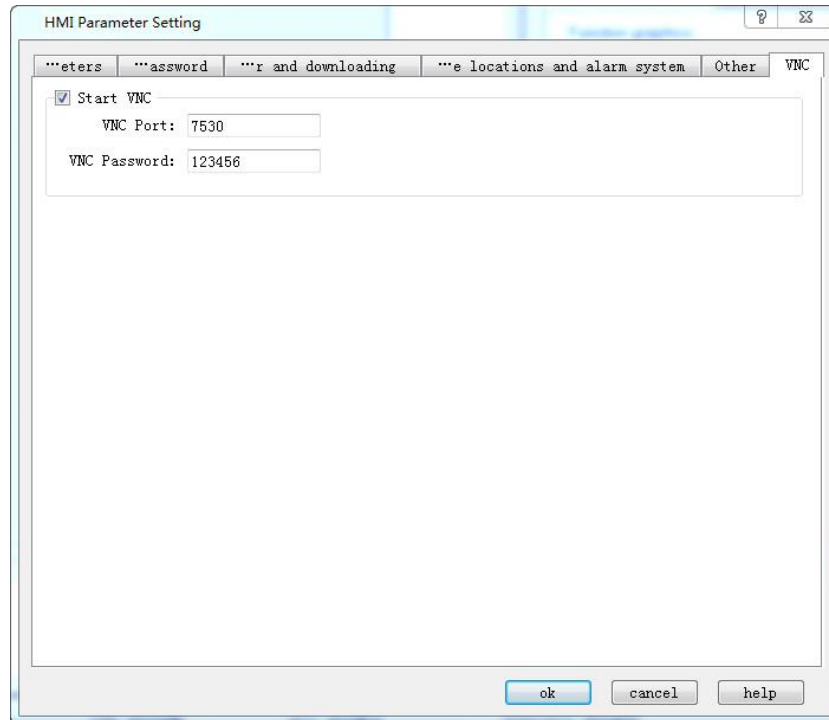

## 16.4 Remote case



### 1. Remote setting

SK The following type of touch screen supports remote function:SK-070GG, SK-070GW, SK-070MG, SK-070MW, SK-102CG, SK-102CW, 以及 SK-070GW connection Modbus RtuEquipment is an example,The configuration of the configuration process is consistent with the touchscreen configuration, which focuses on remote configuration production, creates a good configuration project, and sets the following options:

VNC setting

Touch screen parameter Settings-->VNC setting.Set the VNC function, note: the port number is fixed with 7530, password: free setting



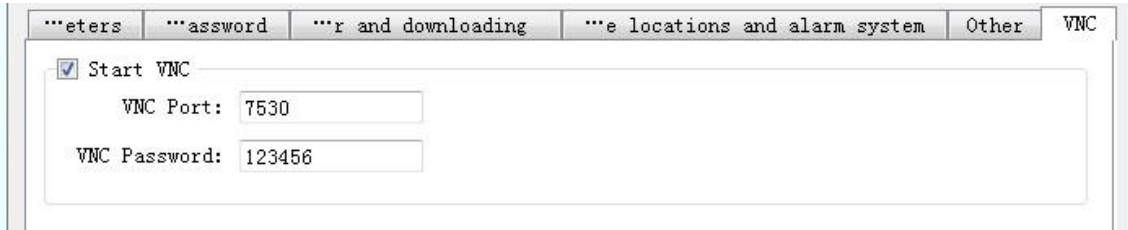

## Remote setting

remote-->Remote Settings. Set the remote display device name and connection password

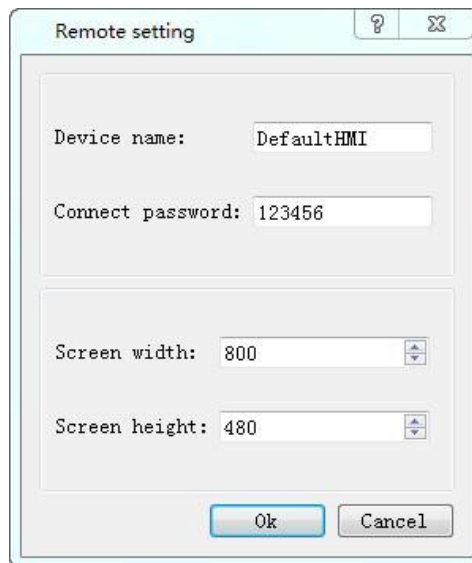

## 2. Set up the configuration interface

Place the button control, set the background color in different state:0x (red)1 (green),Function: alternate,Set the register address 0x0,Using multiple replication capabilities,The address is 1.Copy 8 buttons,As shown below:

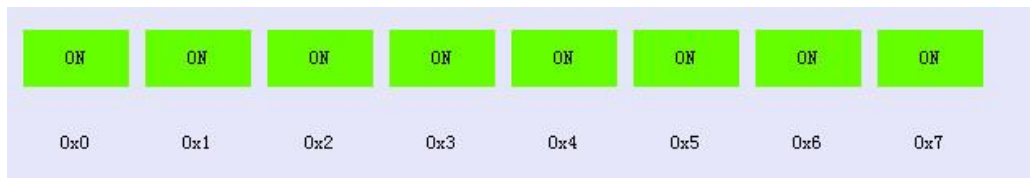
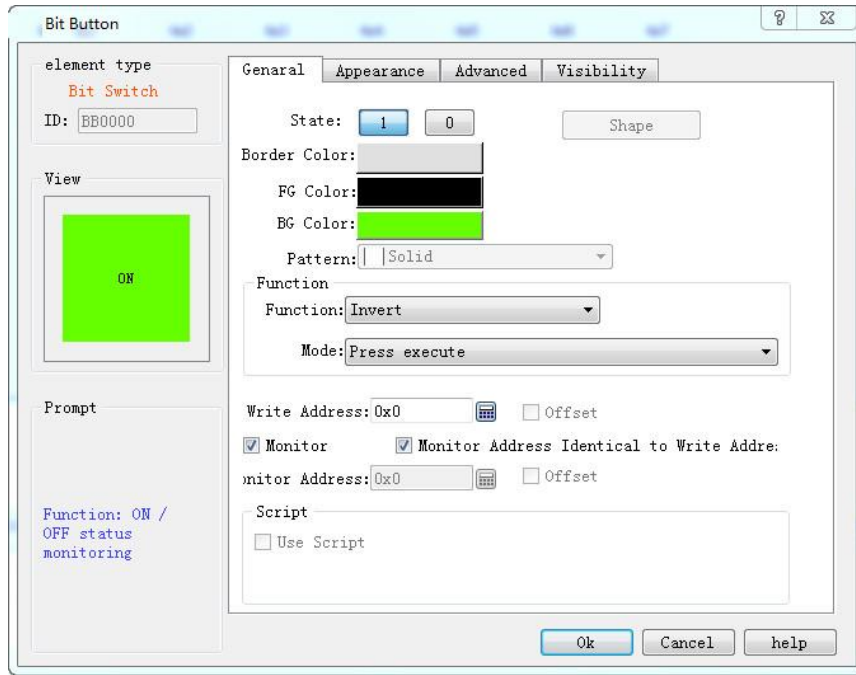

The same step, Place the lw0~ lw7 total 8 number input control

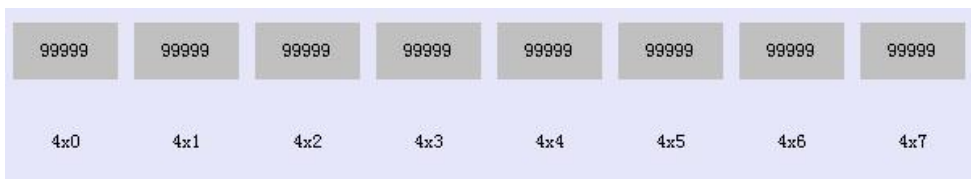
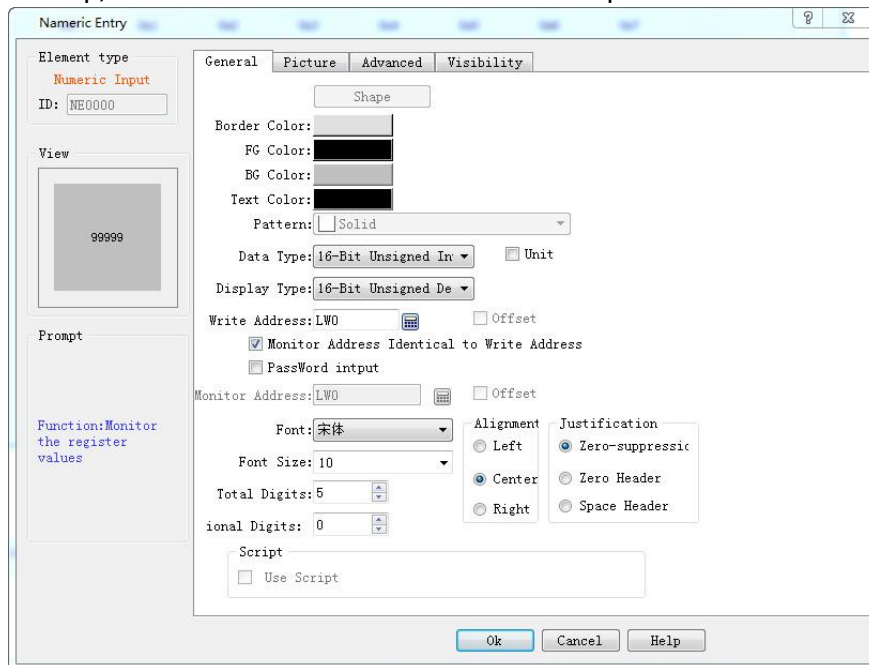

Set alarm information,The current remote only supports the discrete alarm,And you have to check the upload server,So we create the discrete alarm here

Create the address alarm message,Address 0x0,The number of consecutive Numbers,On alarm,And then when you click on that,Create 8 alarm information,Modify each alarm information,Alarm color,As shown below,

|         | Name            | Language    | New   | Delete                              | Delete All |
|---------|-----------------|-------------|-------|-------------------------------------|------------|
|         | Remote alarm    | English     |       |                                     |            |
| Address | Alarm Condition | Message     | Color | Upload                              |            |
| 1 LB0   | ON              | *****LB0 ON | 0+0+0 | <input checked="" type="checkbox"/> |            |
| 2 LB1   | ON              | *****LB1 ON | 0+0+0 | <input checked="" type="checkbox"/> |            |
| 3 LB2   | ON              | *****LB2 ON | 0+0+0 | <input checked="" type="checkbox"/> |            |
| 4 LB3   | ON              | *****LB3 ON | 0+0+0 | <input checked="" type="checkbox"/> |            |
| 5 LB4   | ON              | *****LB4 ON | 0+0+0 | <input checked="" type="checkbox"/> |            |
| 6 LB5   | ON              | *****LB5 ON | 0+0+0 | <input checked="" type="checkbox"/> |            |
| 7 LB6   | ON              | *****LB6 ON | 0+0+0 | <input checked="" type="checkbox"/> |            |
| 8 LB7   | ON              | *****LB7 ON | 0+0+0 | <input checked="" type="checkbox"/> |            |

The same step is shown in the lw0~ lw7 address alarm

**Alarm setting**

Data type: 16-Bit Int      Language: English

Address: LW0      Number: 8

Alarm Message: \*\*\*\*\*150>LW0>100

**Alarm value setting**

Condition: Alarm within the scop      Color: [Black]

Lower limit: 100      Priority: 0

Upper limit: 150       Upload to server

Ok      Cancel

**Alarm Login**

Name: Remote alarm2      Language: English                 

| Address | Alarm Condition     | Message          | Color | Upload                              |
|---------|---------------------|------------------|-------|-------------------------------------|
| 1 LW0   | X > 100 and X < 150 | *****150>LW0>100 | 0+0+0 | <input checked="" type="checkbox"/> |
| 2 LW1   | X > 100 and X < 150 | *****150>LW1>100 | 0+0+0 | <input checked="" type="checkbox"/> |
| 3 LW2   | X > 100 and X < 150 | *****150>LW2>100 | 0+0+0 | <input checked="" type="checkbox"/> |
| 4 LW3   | X > 100 and X < 150 | *****150>LW3>100 | 0+0+0 | <input checked="" type="checkbox"/> |
| 5 LW4   | X > 100 and X < 150 | *****150>LW4>100 | 0+0+0 | <input checked="" type="checkbox"/> |
| 6 LW5   | X > 100 and X < 150 | *****150>LW5>100 | 0+0+0 | <input checked="" type="checkbox"/> |
| 7 LW6   | X > 100 and X < 150 | *****150>LW6>100 | 0+0+0 | <input checked="" type="checkbox"/> |
| 8 LW7   | X > 100 and X < 150 | *****150>LW7>100 | 0+0+0 | <input checked="" type="checkbox"/> |

           Timing Time: 1       Select all                 

Create a macro instruction that sets the current value of the 4x0 at the current value of the 4x0, setting the trigger of the set, as shown below:

**Edit Script Variables**

**Variable setting**

Name: SUM

Date type: 16-Bit Int

Address: 4x0

R/W: R/W

size: 2

**Batch add**

Use batch add

Count: 1

Increasing: 1

OK      Cancel

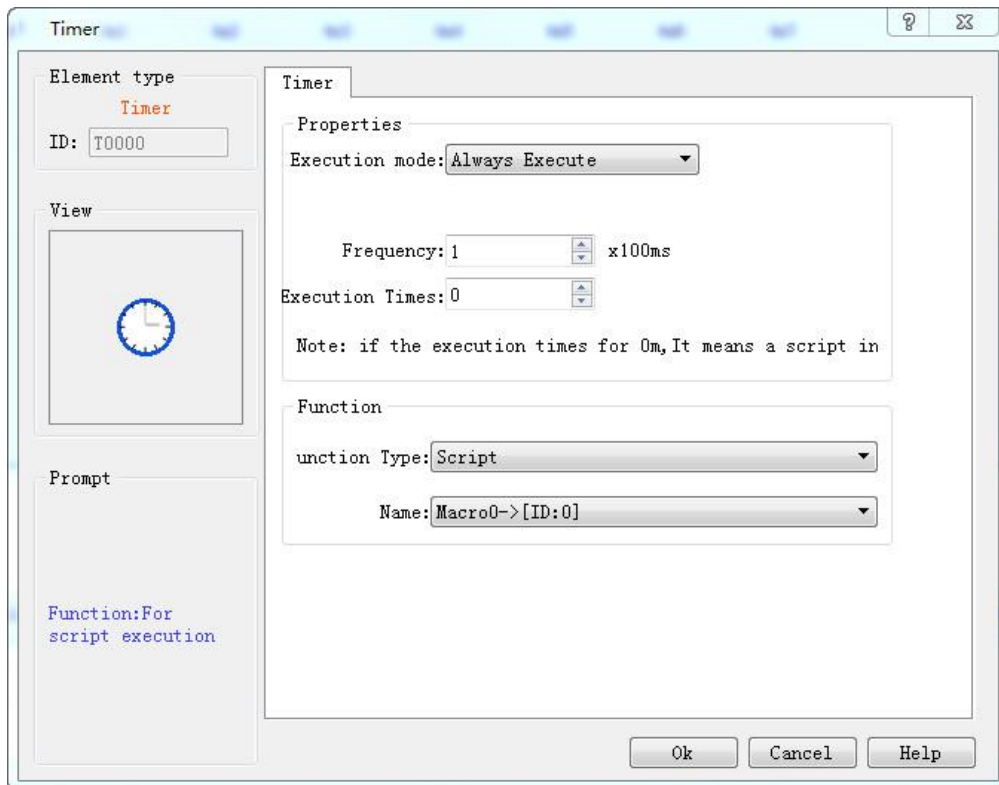
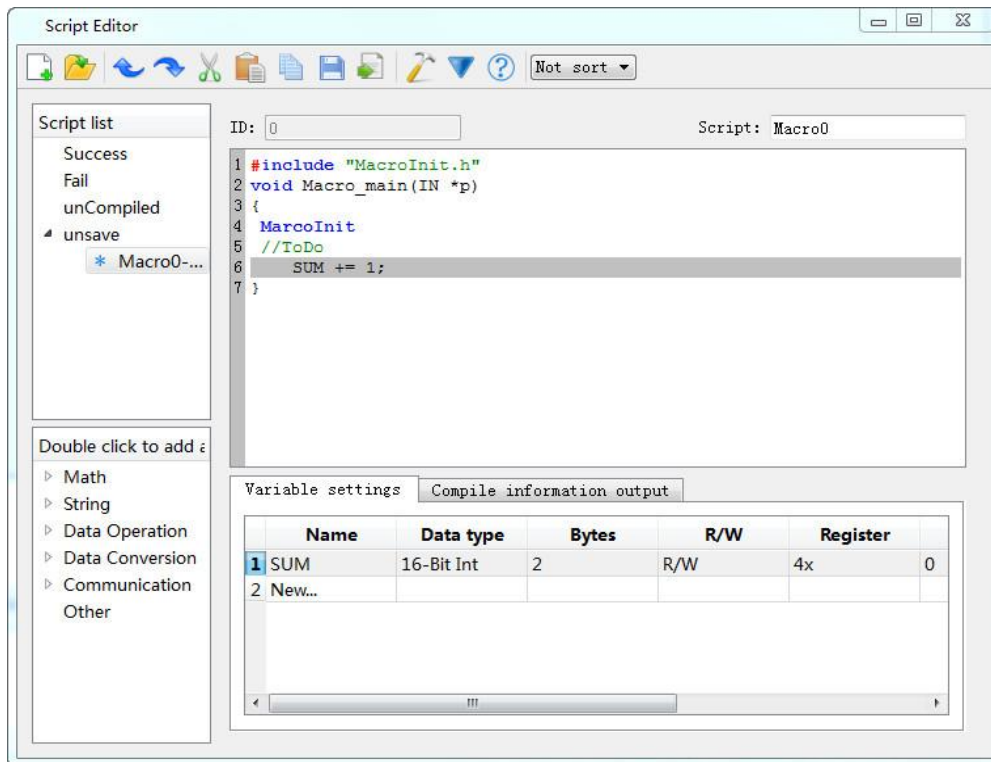

### 3.Remote connection

## 17. FAQ & Solutions

| No.            | Phenomenon   |                              | Reason analysis   | Solution   |
|----------------|--------------|------------------------------|---|--|
| <b>Display</b> | Black Screen | Black screen once powered on | Power problems  | 1、 Check the power supply connection;<br>2、 Check the power type; change the type if it is not independent<br>24VDC ( $\pm 20\%$ ) .                               |
|                |              |                              | There is something wrong with the configuration project, such as wrong application of macro, including applying null pointer, wild pointer, off-normal array, and divisor of 0. | Dial the Dial switch 2 to ON and re-download configuration project to test simply; if macro runs improperly, debug it and apply correct macro programming methods. |
|                |              |                              | Main engine trouble: Flat cable corrosion of LCD, crystal oscillator problem, etc.  | Contact to the after-sale service for depot repair.  |

|              |  |   |                                |  |
|--------------|--|---|--------------------------------|--|
|              |  | Sudden black screen during normal operation; or sometimes black screen, crash | Power problem                  | Check whether the power wire and the power are fine.   |
|              |  |   | Main engine trouble            | Contact to the after-sale service for depot repair.  |
|              |  | Lines on the screen, vertical or horizontal line                              | LCD failure                    | Contact to the after-sale service for depot repair if each screen has the line phenomenon.   |
| <b>Touch</b> | Slow touch response and difficulty to touch controls |   | Installation problem           | 1. Check whether the open hole is so small that it squeezes HMI and if so install it according to right hole size; 2. Check whether setscrews are too tight and ensure the stress of four corners as consistent as possible. |
|              |  |   | Improper configuration project | Too much configuration project message, background macros  |

|                              |  |   |   |   |
|------------------------------|--|---|---|---|
|                              |  |   | and over range screen variables and controls; modify the configuration program, add or reduce controls and screens reasonably.                      |   |
|                              | Touch failure  | Coordinate adjustment or touch panel damage | 1. Dial the dial switch on 1 to execute coordinate adjustment;<br>2. Contact to the after-sale service for depot repair if the former doesn't work. |   |
|                              | Jump wire (In Keyboard, press A but display X or others) | Touch panel failure                         | Contact to the after-sale service for depot repair.   |   |
| <b>Communication failure</b> | Communication outage between HMI and controller          | Communication is unavailable all the time   | Failure of communication devices (PLC, SCM, etc.)   | Ensure fine state of communication port and rematch communication parameters. |
|                              |  |   | Communication port failure of HMI   | Contact to the after-sale service for depot repair.                           |
|                              |  |   | Disconnection of  | Employ specific   |



|  |   |   |   |   |
|--|---|---|---|---|
|  |   |   | communication cable   | cable of Samkoon as far as possible.  |
|  |   | Communication interrupt after a period time of normal operation | Communication wire connection appears corrosion and oxidation due to long-time operation. | Change communication wire or re-weld it.  |
|  |   |   | Environment interference  | Shield interference source reasonably; employ shielded wire; proper ground connection |
|  |   |   | Main engine trouble of HMI ( due to strong magnet and current or lightning at scene)      | Contact to the after-sale service for depot repair.                                   |
|  | HMI cannot connect PC and downloading is unavailable. |   | Wrong installation of PC USB driver   | Select corresponding system driver and reinstall USB driver.                          |
|  |   |   | Size and model of HMI are inconsistent with the actual ones.                              | Modify and match the right model of HMI in configuration software.                    |
|  |   |   | Damage of HMI   | Contact to the  |

|                    |  |   |  |
|--------------------|--|---|--|
|                    |  | downloading port  | after-sale service for depot repair. (check method: Connect another HMI with the same USB cable and PC to see whether downloading is available; if so, fault point locates on the USB communication port of HMI) |
| <b>Application</b> | Unavailable configuration  | Illegal control or macro in configuration               | Modify the configuration   |
|                    | Unsuccessful macro compilation                                   | Installation directory of SK in environmental variables | Bring forward the installation directory of SKTOOL in environmental variables.   |
|                    | Off-line and On-line simulation cannot function in the meantime. | Run without administrator rights                        | Run SKTOOL as administrator  |

## 18. Contact



# 深圳市显控科技股份有限公司

Shenzhen Samkoon Technology Corporation  
Ltd.

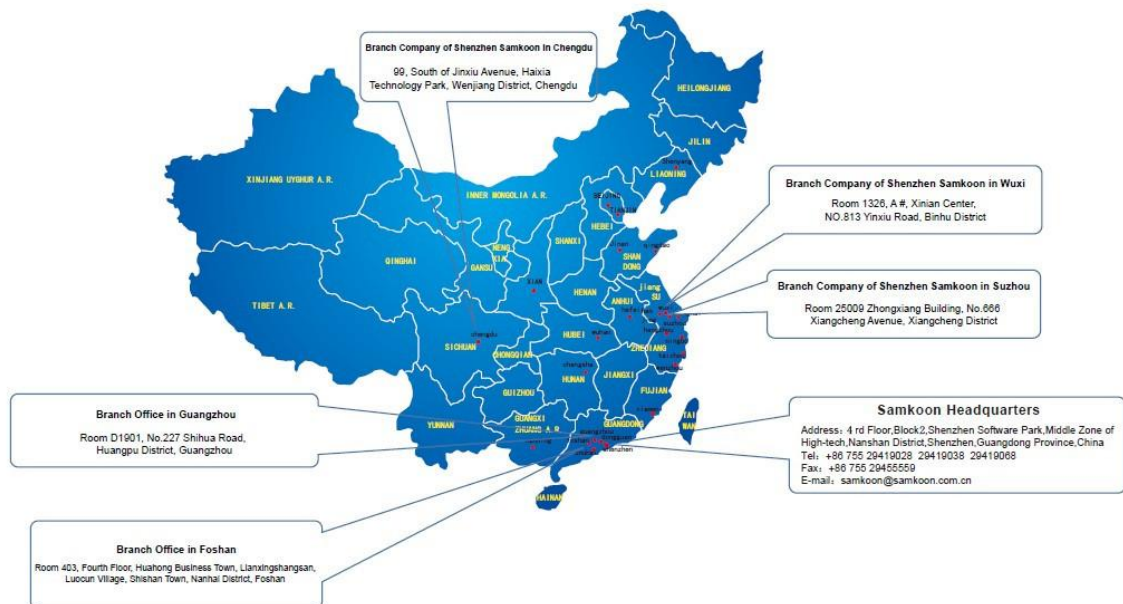

Note : Samkoon establishes offices in major cities all over the country; please contact officers in head office for details.

### Contact

·Address: 4rd Floor, Block 2, Shenzhen software park, Middle Zone of High-tech,  
Nanshan District, Shenzhen, China.

·Postcode: 518057

·Tel: 0755-29419038 29419068

·Fax: 0755-29455559

·Email: samkoon@samkoon.com.cn

·Web: <http://www.samkoon.com.cn>